



SOPHSON INDUSTRY CO., LTD

Sophsion Industry Co., Ltd is known as a leader in design, development, supplying of fittings for the hydraulic and pneumatic system. Through years of developing products, our highly experienced staff works closely with our customers to ensure components, as well as complete systems, fit specific application requirements.

Quality is ensured through strict process control of CNC equipment, testing equipment. Our machines are able to accommodate a wide variety of materials from aluminum, brass, steels and stainless steels to plastics such as nylon and polypropylene. Through the full implementation of the ISO9001 quality system, we are producing various plastic pneumatic, brass components, steel couplings that meet and exceed customer standards.



| | |
|--|---|
| 过渡接头代号说明 How To Order Adapter | A |
| DIN卡套接头 DIN Bite Type Tube Fittings | B |
| 日本公制螺纹60° 锥面密封接头 Japanese Metric Thread 60° Cone Fittings | C |
| 其它公制螺纹接头 Other Metric Thread Fittings | D |
| 日本英管螺纹60° 锥面密封接头 Japanese BSP Thread 60° Cone Fittings | E |
| 英管螺纹60° 锥面密封接头 BSP Thread 60° Cone Fittings | F |
| 英锥管螺纹BSPT接头 BSPT Thread Fittings | G |
| 美制螺纹JIC 74° 锥面扩口接头 JIC 74° Cone Flared Tube Fittings | H |
| 美制螺纹O型圈平面密封接头 ORFS Fittings | I |
| 美制锥管螺纹NPT接头 NPT Thread Fittings | J |
| 美制螺纹NPSM接头 NPSM Fittings | K |
| 美制SAE外螺纹90° 外锥接头 SAE Male 90° Cone Fittings | L |
| 法兰接头 Flange Fittings | M |
| 附加资料 Information | N |

过渡接头代号说明 How to order adapter

1 直通过渡接头代号 Straight part NO.

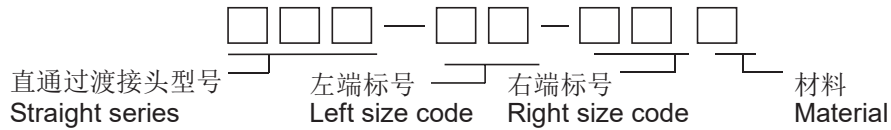

2 角弯过渡接头代号：在直通过渡接头型号后加“4”表示45°弯曲过渡接头，在直通过渡接头型号后加“9”表示90°弯曲过渡接头。如1BG9-04OG,1JT4-08-06SP等。
Elbow part NO.: Add suffix "4" for 45° elbow and suffix "9" for 90° elbow to the straight part number. e.g, 1BG9-04OG and 1JT4-08-06SP.

3 三通过渡接头代号 Tee part NO.

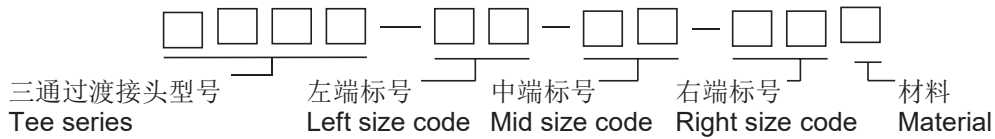

4 四通过渡接头代号 Cross part NO.

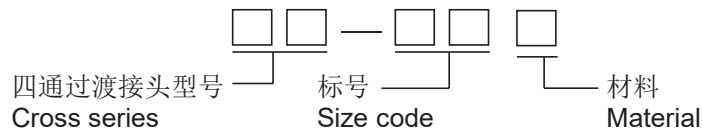

对四通过渡接头一般四端都相同，因此只注一个标号。如四端不同，则第一组表示左端，第二组表示上端，第三组表示右端，第四组表示下端。

In general for cross fitting, the four ends thread is the same. If different, the first group means left, the second group means up, the third group means right and the fourth group means down.

5 当材料代号为碳钢时，则不标注材料代号，其他材料的代号如下表所示。

Don't need material code if the material is carbon steel, and the code for other materials is defined as following:

| 材料 Material | 碳钢 Carbon steel | 铜 Brass | 不锈钢 Stainless steel |
|-------------|-----------------|---------|---------------------|
| 代号 Code | — | BR | SS |

过渡接头代号说明 How To Order Adapter

6 标号根据螺纹或尺寸大小来规定，具体按下表所示。 Size code table:

| | | | | | | | | | | | |
|---|---------------|---------------|-------------|---------------|---------------|--------------|----------------|----------------|------------------|------------------|---------------|
| 英管螺纹 BSP Thread | G1/8" x28 | G1/4" x19 | — | G3/8" x19 | G1/2" x14 | G5/8" x14 | G3/4" x14 | G1"x11 | G1.1/4" x11 | G1.1/2" x11 | G2"x11 |
| 英锥管螺纹 BSPT Thread | R1/8" x28 | R1/4" x19 | — | R3/8" x19 | R1/2" x14 | — | R3/4" x14 | R1"x11 | R1.1/4" x11 | R1.1/2" x11 | R2"x11 |
| 布锥管螺纹 NPT Thread | Z 1/8" x27 | Z 1/4" x18 | — | Z 3/8" x18 | Z 1/2" x14 | — | Z3/4" x14 | Z1"x11.5 | Z1.1/4" x11.5 | Z1.1/2" x11.5 | Z2" x11.5 |
| 美制JIC 螺纹 JIC Thread | — | 7/16" x20 | 1/2" x20 | 9/16" x18 | 3/4" x16 | 7/8" x14 | 1.1/16" x12 | 1.5/16" x12 | 1.5/8" x12 | 1.7/8" x12 | 2.1/2" x12 |
| 美制ORFS 螺纹 ORFS Thread | — | 9/16" x18 | — | 11/16" x16 | 13/16" x16 | 1" x14 | 1.3/16" x12 | 1.7/16" x12 | 1.11/16" x12 | 2" x12 | — |
| 美制SAE 螺纹 SAE Thread | — | — | — | 5/8" x18 | — | — | 1.1/16" x14 | — | — | — | — |
| 法兰 Flange size | — | — | — | — | 1/2" | 5/8" | 3/4" | 1" | 1.1/4" | 1.1/2" | 2" |
| 标号 Size code | 02 | 04 | 05 | 06 | 08 | 10 | 12 | 16 | 20 | 24 | 32 |
| 注：公制螺纹标号与螺纹外径一致。 Note: The size of metric thread accords with the O.D. of thread. | | | | | | | | | | | |

标注示例： Example of order:

1BG直通过渡接头系列，左端接头螺纹为G1/2"X14，右端接头螺纹为G3/4"X14，用碳钢制作的接头，代号为1BG-08-12，如用不锈钢制作，代号为1BG-08-12SS。

If 1BG' left end thread is G1/2" x 14 and right end thread is G3/4" x 14, the carbon steel fitting number is 1BG-08-12. If made of stainless steel, the fitting number is 1BG-08-12SS.

AJJN三通过渡接头系列，左端接头螺纹为9/16"x18，中端接头螺纹为9/16"x18，右端接头螺纹为Z1/2"x14，用碳钢制作的接头，代号为AJJN-06-06-08。

If AJJN' left end thread is 9/16" x 18, mid end thread is 9/16" x 18 and right end thread is Z1/2" x 14, the carbon steel fitting number is AJJN-06-06-08.

过渡接头编号规则

一、直通过渡接头编号规则：

| 第一位数字 | 第二或第三位字母 |
|--------------------------|--------------------|
| 1外螺纹/外螺纹 | A英管螺纹球面 |
| 2外螺纹/活动内螺纹(扣压螺母) | B英管螺纹60°锥面 |
| 3活动内螺纹(扣压螺母)/活动内螺纹(扣压螺母) | C公制24°轻系列 |
| 4外螺纹堵头 | D公制24°重系列 |
| 5衬套(外螺纹/固定内螺纹) | E公制平面带O形圈 |
| 6过板接头 | F美制ORFS平面 |
| 7固定内螺纹/固定内螺纹(无螺母) | G英管螺纹平面、O-Ring密封 |
| 8锁母 | H公制六角端面O-Ring密封 |
| 9内螺纹堵头(扣压螺母) | J美制JIC 74° |
| | K公制外螺纹60°外锥(小松) |
| | L公制组合垫圈密封 |
| | M公制60° |
| | N美制布锥管 |
| | O美制SAE O-Ring BOSS |
| | P美制SAE 90° |
| | Q公制74° |
| | S日式英管外螺纹60°外锥 |
| | T英锥管螺纹 |
| | U NPSM |
| | W焊接管 |
| | Y煤矿接头(SAE标准) |
| | Z BSP平面用组合垫圈密封 |

- 1 在原代号后加“OR”，表示在60°、74°、90°外锥面上加O-RING，如1J-06-04OR，表示第二端即-04端锥面上加O-RING；1J-06-04/2OR表示两端即-06端及-04端均加O-RING。
- 2 固定内螺纹/活动内螺纹(扣压螺母)的表示方法为第一位数字为7，再在后面加S(注：S为SWIVEL的第一个字母)，如7B-08S、7NU-08S。
- 3 外螺纹/活动内螺纹(套螺母)的表示方法为第一位数字为5，再在后面加S(注：S为SWIVEL的第一个字母)，如5J-08-12S。
- 4 W端焊接管较短时，在代号后加S(注：S为SHORT的第一个字母)，如3BW-08-20S。
- 5 对用于卡套式的直管，用W表示，并在后面加P，如1BW-08-18P，表示第二端为直管，用于卡套式，不是用于焊接式。
- 6 焊接管的尺寸为英寸制时，在代号后加IN，如5JW-08IN、3JW-12S/IN。
- 7 内六角外螺纹堵头在原代号中加N，如4TN-08、4NN-08、4BN-08、4ON-08等。
- 8 用CAPTIVE密封的接头型式，在代号后加WD，如1B-08-12WD，表示第二端即-12端为CAPTIVE密封型式；1B-08-12/2WD，表示-08及-12两端均为CAPTIVE密封型式。
- 9 对J端加长的过渡接头，在代号后加L，如1JO-08L。
- 10 对表接头在代号后加G，如2TB-08G。
- 11 对转接头在代号后加OG，如1JG9-08-10OG、AJOJ-08OG等。
- 12 对T端接头需加工60°内锥面的接头，在代号后加SP，如1BT-08SP。
- 13 24°带O-RING锥密封接头，如使用GB标准规格的O-RING，在代号后加GN。

二、角弯过渡接头编号规则：

在直通过渡接头编号后加“4”表示45°弯曲过渡接头，在直通过渡接头编号后加“9”表示90°弯曲过渡接头。

过渡接头代号说明 How To Order Adapter

三、三通过渡接头编号规则：

第一个字母的含义如下所示，其余字母的含义同直通过渡接头中的第二或第三位字母。

- A 外螺纹/外螺纹/外螺纹
- B 外螺纹/活动内螺纹/外螺纹
- C 外螺纹/外螺纹/活动内螺纹
- D 活动内螺纹/活动内螺纹/活动内螺纹
- E 活动内螺纹/外螺纹/活动内螺纹
- F 活动内螺纹/活动内螺纹/外螺纹
- G 固定内螺纹/固定内螺纹/固定内螺纹
- H 固定内螺纹/固定内螺纹/外螺纹
- J 固定内螺纹/外螺纹/固定内螺纹
- K 外螺纹/固定内螺纹/外螺纹
- L 外螺纹/外螺纹/固定内螺纹
- M 活动内螺纹/固定内螺纹/活动内螺纹
- N 外螺纹/固定内螺纹/活动内螺纹
- P 固定内螺纹/外螺纹/活动内螺纹
- Q 固定内螺纹/活动内螺纹/外螺纹

四、四通过渡接头：

第一个字母X表示四端都是外螺纹的四通。

第一个字母Y表示四端都是活动内螺纹的四通。

第一个字母Z表示四端都是固定内螺纹的四通。







其余字母的含义同直通过渡接头中的第二或第三位字母，如XB-08，YB-08，ZB-08等。

- A
- B
- C
- D

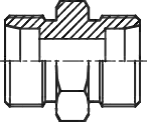
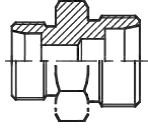
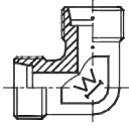
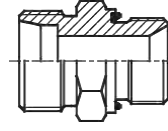
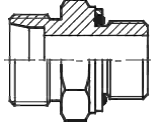
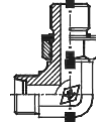
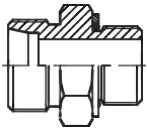
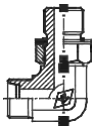
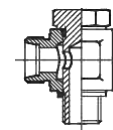
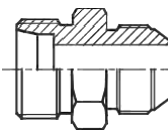
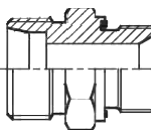
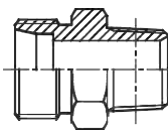
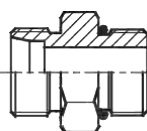
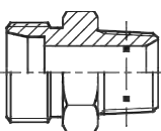
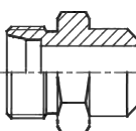
公制螺纹接头
Metric Thread Fittings

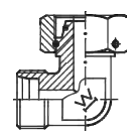
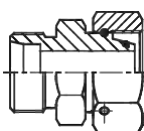
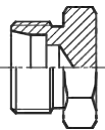
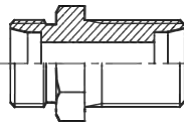
DIN卡套接头
DIN Bite Type Tube Fittings
日本公制螺纹60° 锥面密封接头
Japanese Metric Thread 60° Cone Fittings
其它公制螺纹接头
Other Metric Thread Fittings

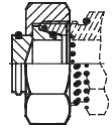
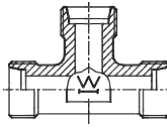
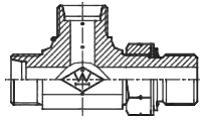
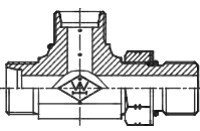
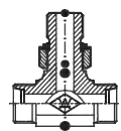
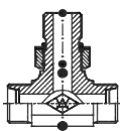
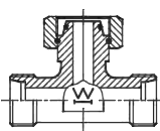
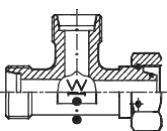
型号索引 Part NO. Index

| | | | | | |
|--|--|--|--|--|--|
|  1C、1D PB1 |  1C、1D变径 PB2 |  1C9、1D9 PB3 |  1CB-WD、1DB-WD PB4 |  1CG、1DG PB5 |  1CG9-OG、1DG9-OG PB6 |
|  1CH、1DH PB7 |  1CH9-OG、1DH9-OG PB8 |  1CI、1DI PB9 |  1CJ、1DJ PB10 |  1CM-WD、1DM-WD PB11 |  1CN、1DN PB12 |
|  1CO、1DO PB13 |  1CT-SP、1DT-SP PB14 |  1CW、1DW PB15 |  2C PB16 |  2C9、2D9 PB17 |  2D PB18 |
|  4C、4D PB19 |  6C、6D PB20 |  8C PB21 |  9C、9D PB22 |  AC、AD PB23 |  ACCH-OG、ADDH-OG PB24 |
|  ACCO-OG、ADDO-OG PB25 |  ACHC-OG、ADHD-OG PB26 |  ACOC-OG、ADOD-OG PB27 |  BC、BD PB28 |  CC、CD PB29 |  NL、NS PB30 |
|  RL、RS PB31 | | | | | |
| | | | | | |

DIN卡套接头 DIN Bite Type Tube Fittings

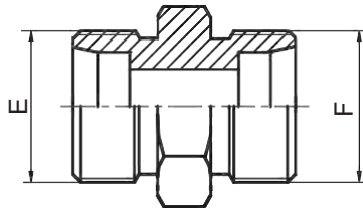

1C
1D

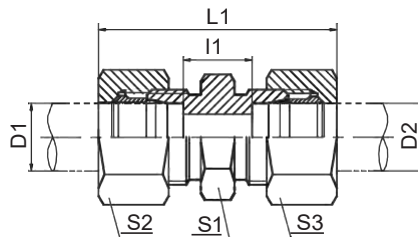

1C-RN
1D-RN

直通接头
STRAIGHT FITTINGS

| 代号 PART NO. | 螺 纹 THREAD | | 管子外径 TUBE O.D. | | 尺 寸 DIMENSIONS | | | | | | 压力等级 MPa |
|----------------|------------|---------|----------------|----|----------------|----|----|----|----|------------------|-------------|
| | E | F | D1 | D2 | I1 | L1 | S1 | S2 | S3 | | |
| 1C-12 | M12X1.5 | M12X1.5 | 6 | 6 | 10 | 39 | 12 | 14 | 14 | 31.5 轻系列 L | |
| 1C-14 | M14X1.5 | M14X1.5 | 8 | 8 | 11 | 40 | 14 | 17 | 17 | | |
| 1C-16 | M16X1.5 | M16X1.5 | 10 | 10 | 13 | 42 | 17 | 19 | 19 | | |
| 1C-18 | M18X1.5 | M18X1.5 | 12 | 12 | 14 | 43 | 19 | 22 | 22 | | |
| 1C-22 | M22X1.5 | M22X1.5 | 15 | 15 | 16 | 46 | 24 | 27 | 27 | | |
| 1C-26 | M26X1.5 | M26X1.5 | 18 | 18 | 16 | 48 | 27 | 32 | 32 | | |
| 1C-30 | M30X2 | M30X2 | 22 | 22 | 20 | 52 | 32 | 36 | 36 | 16 轻系列 L | |
| 1C-36 | M36X2 | M36X2 | 28 | 28 | 21 | 54 | 41 | 41 | 41 | | |
| 1C-45 | M45X2 | M45X2 | 35 | 35 | 20 | 63 | 46 | 50 | 50 | | |
| 1C-52 | M52X2 | M52X2 | 42 | 42 | 21 | 66 | 55 | 60 | 60 | 63 重系列 S | |
| 1D-14 | M14X1.5 | M14X1.5 | 6 | 6 | 16 | 45 | 14 | 17 | 17 | | |
| 1D-16 | M16X1.5 | M16X1.5 | 8 | 8 | 18 | 47 | 17 | 19 | 19 | | |
| 1D-18 | M18X1.5 | M18X1.5 | 10 | 10 | 17 | 49 | 19 | 22 | 22 | | |
| 1D-20 | M20X1.5 | M20X1.5 | 12 | 12 | 19 | 51 | 22 | 24 | 24 | | |
| 1D-22 | M22X1.5 | M22X1.5 | 14 | 14 | 22 | 57 | 24 | 27 | 27 | 40 重系列 S | |
| 1D-24 | M24X1.5 | M24X1.5 | 16 | 16 | 21 | 57 | 27 | 30 | 30 | | |
| 1D-30 | M30X2 | M30X2 | 20 | 20 | 23 | 66 | 32 | 36 | 36 | | |
| 1D-36 | M36X2 | M36X2 | 25 | 25 | 26 | 74 | 41 | 46 | 46 | | |
| 1D-42 | M42X2 | M42X2 | 30 | 30 | 27 | 80 | 46 | 50 | 50 | 31.5重系列S | |
| 1D-52 | M52X2 | M52X2 | 38 | 38 | 29 | 90 | 55 | 60 | 60 | | |

注：如需带卡套及卡套螺母整套订货，则请在代号后加“RN”，如1C9-30RN。

Note: In case if you are interested to order the adapter in complete set with cutting ring and nut ,it is necessary to insert suffix "RN" after our part no., for example 1C-30RN.

DIN卡套接头 DIN Bite Type Tube Fittings

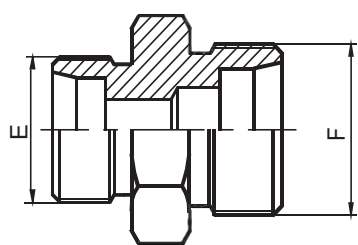

1C
1D

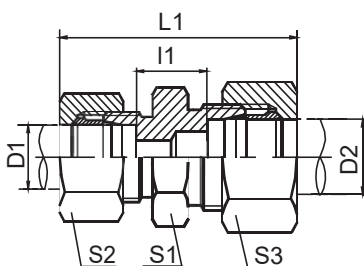

1C-RN
1D-RN

直通变径接头
STRAIGHT REDUCERS

| 代号 PART NO. | 螺纹 THREAD | | 管子外径 TUBE O.D. | | 尺寸 DIMENSIONS | | | | | 压力等级 MPa |
|----------------|-----------|---------|----------------|----|---------------|------|----|----|----|------------------|
| | E | F | D1 | D2 | L1 | l1 | S1 | S2 | S3 | |
| 1C-12-14 | M12X1.5 | M14X1.5 | 6 | 8 | 40 | 11 | 14 | 15 | 17 | 31.5 轻系列 L |
| 1C-12-16 | M12X1.5 | M16X1.5 | 6 | 10 | 41 | 12 | 17 | 15 | 19 | |
| 1C-12-18 | M12X1.5 | M18X1.5 | 6 | 12 | 42 | 13 | 19 | 15 | 22 | |
| 1C-14-16 | M14X1.5 | M16X1.5 | 8 | 10 | 41 | 12 | 17 | 17 | 19 | |
| 1C-14-18 | M14X1.5 | M18X1.5 | 8 | 12 | 42 | 13 | 19 | 17 | 22 | |
| 1C-16-18 | M16X1.5 | M18X1.5 | 10 | 12 | 43 | 14 | 19 | 19 | 22 | |
| 1C-16-22 | M16X1.5 | M22X1.5 | 10 | 15 | 44.5 | 15 | 24 | 19 | 27 | |
| 1C-16-26 | M16X1.5 | M26X1.5 | 10 | 18 | 46 | 15.5 | 27 | 19 | 32 | |
| 1C-18-22 | M18X1.5 | M22X1.5 | 12 | 15 | 44.5 | 15 | 24 | 22 | 27 | |
| 1C-18-26 | M18X1.5 | M26X1.5 | 12 | 18 | 46 | 15.5 | 27 | 22 | 32 | |
| 1C-18-30 | M18X1.5 | M30X2 | 12 | 22 | 48 | 17.5 | 32 | 22 | 36 | |
| 1C-22-26 | M22X1.5 | M26X1.5 | 15 | 18 | 47.5 | 16.5 | 27 | 27 | 32 | |
| 1C-22-30 | M22X1.5 | M30X2 | 15 | 22 | 49.5 | 18.5 | 32 | 27 | 36 | |
| 1C-26-30 | M26X1.5 | M30X2 | 18 | 22 | 50 | 18 | 32 | 32 | 36 | |
| 1C-26-36 | M26X1.5 | M36X2 | 18 | 28 | 51.5 | 19 | 41 | 32 | 41 | |
| 1C-30-36 | M30X2 | M36X2 | 22 | 28 | 53.5 | 21 | 41 | 36 | 41 | |
| 1C-30-45 | M30X2 | M45X2 | 22 | 35 | 58.5 | 21 | 46 | 36 | 50 | |
| 1C-36-45 | M36X2 | M45X2 | 28 | 35 | 59 | 21 | 46 | 41 | 50 | |
| 1D-14-16 | M14X1.5 | M16X1.5 | 6 | 8 | 47 | 18 | 17 | 17 | 19 | |
| 1D-14-18 | M14X1.5 | M18X1.5 | 6 | 10 | 48 | 17.5 | 19 | 17 | 22 | |
| 1D-14-20 | M14X1.5 | M20X1.5 | 6 | 12 | 50 | 19.5 | 22 | 17 | 24 | |
| 1D-16-18 | M16X1.5 | M18X1.5 | 8 | 10 | 48 | 17.5 | 19 | 19 | 22 | |
| 1D-16-20 | M16X1.5 | M20X1.5 | 8 | 12 | 50 | 19.5 | 22 | 19 | 24 | |
| 1D-18-20 | M18X1.5 | M20X1.5 | 10 | 12 | 51 | 19 | 22 | 22 | 24 | |
| 1D-18-22 | M18X1.5 | M22X1.5 | 10 | 14 | 54 | 20.5 | 24 | 22 | 27 | |
| 1D-18-30 | M18X1.5 | M30X2 | 10 | 20 | 59.5 | 22 | 32 | 22 | 36 | |
| 1D-20-22 | M20X1.5 | M22X1.5 | 12 | 14 | 54 | 20.5 | 24 | 24 | 27 | |
| 1D-20-24 | M20X1.5 | M24X1.5 | 12 | 16 | 54 | 20 | 27 | 24 | 30 | |
| 1D-20-30 | M20X1.5 | M30X2 | 12 | 20 | 59.5 | 22 | 32 | 24 | 36 | |
| 1D-22-24 | M22X1.5 | M24X1.5 | 14 | 16 | 57 | 21.5 | 27 | 27 | 30 | |
| 1D-24-30 | M24X1.5 | M30X2 | 16 | 20 | 62.5 | 23 | 32 | 30 | 36 | |
| 1D-24-36 | M24X1.5 | M36X2 | 16 | 25 | 67.5 | 25.5 | 41 | 30 | 46 | |
| 1D-30-36 | M30X2 | M36X2 | 20 | 25 | 71 | 25.5 | 41 | 36 | 46 | |
| 1D-30-42 | M30X2 | M42X2 | 20 | 30 | 74 | 26 | 46 | 36 | 50 | |
| 1D-36-42 | M36X2 | M42X2 | 25 | 30 | 77 | 26.5 | 46 | 46 | 50 | |
| 1D-42-52 | M42X2 | M52X2 | 30 | 38 | 86.5 | 28.5 | 55 | 50 | 60 | 31.5重系列S |

注：如需带卡套及卡套螺母整套订货，则请在代号后加“RN”，如1C-30-36RN。

Note: In case if you are interested to order the adapter in complete set with cutting ring and nut, it is necessary to insert suffix "RN" after our part no., for example 1C-30-36RN.

DIN卡套接头 DIN Bite Type Tube Fittings

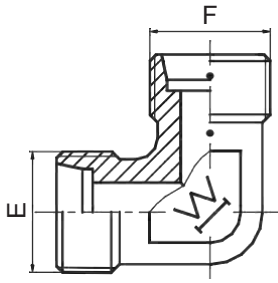

1C9
1D9

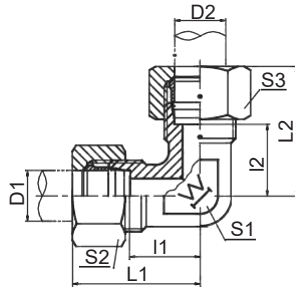

1C9-RN
1D9-RN

90° 弯曲接头
90° ELBOW FITTINGS

| 代号 PART NO. | 螺 纹 THREAD | | 管子外径 TUBE O.D. | | 尺 寸 DIMENSIONS | | | | | | 压力等级 MPa |
|----------------|------------|---------|----------------|----|----------------|-------|----|-------|--|--|------------------|
| | E | F | D1 | D2 | I1,I2 | L1,L2 | S1 | S2,S3 | | | |
| 1C9-12 | M12X1.5 | M12X1.5 | 6 | 6 | 12 | 27 | 12 | 14 | | | 31.5 轻系列 L |
| 1C9-14 | M14X1.5 | M14X1.5 | 8 | 8 | 14 | 29 | 12 | 17 | | | |
| 1C9-16 | M16X1.5 | M16X1.5 | 10 | 10 | 15 | 30 | 14 | 19 | | | |
| 1C9-18 | M18X1.5 | M18X1.5 | 12 | 12 | 17 | 32 | 17 | 22 | | | |
| 1C9-22 | M22X1.5 | M22X1.5 | 15 | 15 | 21 | 36 | 19 | 27 | | | |
| 1C9-26 | M26X1.5 | M26X1.5 | 18 | 18 | 23.5 | 40 | 24 | 32 | | | |
| 1C9-30 | M30X2 | M30X2 | 22 | 22 | 27.5 | 44 | 27 | 36 | | | 16 轻系列 L |
| 1C9-36 | M36X2 | M36X2 | 28 | 28 | 30.5 | 47 | 36 | 41 | | | |
| 1C9-45 | M45X2 | M45X2 | 35 | 35 | 34.5 | 56 | 41 | 50 | | | |
| 1C9-52 | M52X2 | M52X2 | 42 | 42 | 40 | 63 | 50 | 60 | | | 63 重系列 S |
| 1D9-14 | M14X1.5 | M14X1.5 | 6 | 6 | 16 | 31 | 12 | 17 | | | |
| 1D9-16 | M16X1.5 | M16X1.5 | 8 | 8 | 17 | 32 | 14 | 19 | | | |
| 1D9-18 | M18X1.5 | M18X1.5 | 10 | 10 | 17.5 | 34 | 17 | 22 | | | |
| 1D9-20 | M20X1.5 | M20X1.5 | 12 | 12 | 21.5 | 38 | 17 | 24 | | | |
| 1D9-22 | M22X1.5 | M22X1.5 | 14 | 14 | 22 | 40 | 19 | 27 | | | 40 重系列 S |
| 1D9-24 | M24X1.5 | M24X1.5 | 16 | 16 | 24.5 | 43 | 24 | 30 | | | |
| 1D9-30 | M30X2 | M30X2 | 20 | 20 | 26.5 | 48 | 27 | 36 | | | |
| 1D9-36 | M36X2 | M36X2 | 25 | 25 | 30 | 54 | 36 | 46 | | | |
| 1D9-42 | M42X2 | M42X2 | 30 | 30 | 35.5 | 62 | 41 | 50 | | | 31.5 重系列S |
| 1D9-52 | M52X2 | M52X2 | 38 | 38 | 41 | 72 | 50 | 60 | | | |

注：如需带卡套及卡套螺母整套订货，则请在代号后加“RN”，如1C9-30RN。

Note: In case if you are interested to order the adapter in complete set with cutting ring and nut ,it is necessary to insert suffix "RN" after our part no., for example 1C9-30RN.

DIN卡套接头 DIN Bite Type Tube Fittings

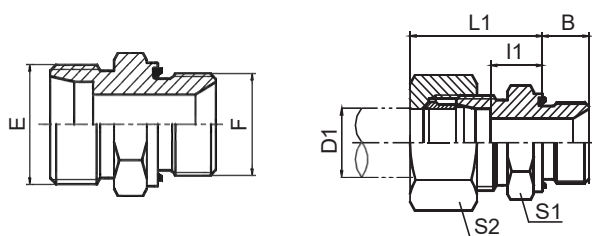

英管螺纹胶垫密封柱端
BSP THREAD WITH CAPTIVE SEAL

1CB-WD
1DB-WD

1CB-WDRN
1DB-WDRN

| 代号 PART NO. | 螺纹 THREAD | | 管子外径 TUBE O.D. | | 尺寸 DIMENSIONS | | | | | 压力等级 MPa |
|----------------|--------------|------------|-------------------|--|------------------|------|------|----|----|------------------|
| | E | F | D1 | | B | l1 | L1 | S1 | S2 | |
| 1CB-12-02WD | M12X1.5 | G1/8"X28 | 6 | | 8 | 9.5 | 23.5 | 14 | 14 | 31.5 轻系列 L |
| 1CB-12-04WD | M12X1.5 | G1/4"X19 | 6 | | 12 | 10 | 25 | 19 | 14 | |
| 1CB-12-06WD | M12X1.5 | G3/8"X19 | 6 | | 12 | 11.5 | 26.5 | 22 | 14 | |
| 1CB-14-02WD | M14X1.5 | G1/8"X28 | 8 | | 8 | 9.5 | 24 | 14 | 17 | |
| 1CB-14-04WD | M14X1.5 | G1/4"X19 | 8 | | 12 | 10 | 24 | 19 | 17 | |
| 1CB-14-06WD | M14X1.5 | G3/8"X19 | 8 | | 12 | 11.5 | 26 | 22 | 17 | |
| 1CB-16-04WD | M16X1.5 | G1/4"X19 | 10 | | 12 | 11 | 24.5 | 19 | 19 | |
| 1CB-16-06WD | M16X1.5 | G3/8"X19 | 10 | | 12 | 12.5 | 26 | 22 | 19 | |
| 1CB-16-08WD | M16X1.5 | G1/2"X14 | 10 | | 14 | 14 | 28 | 27 | 19 | |
| 1CB-18-04WD | M18X1.5 | G1/4"X19 | 12 | | 12 | 11 | 27 | 19 | 22 | |
| 1CB-18-06WD | M18X1.5 | G3/8"X19 | 12 | | 12 | 12.5 | 26 | 22 | 22 | |
| 1CB-18-08WD | M18X1.5 | G1/2"X14 | 12 | | 14 | 14 | 28 | 27 | 22 | |
| 1CB-22-04WD | M22X1.5 | G1/4"X19 | 15 | | 12 | 13 | 28 | 24 | 27 | |
| 1CB-22-06WD | M22X1.5 | G3/8"X19 | 15 | | 12 | 13.5 | 28 | 24 | 27 | |
| 1CB-22-08WD | M22X1.5 | G1/2"X14 | 15 | | 14 | 15 | 29 | 27 | 27 | |
| 1CB-22-12WD | M22X1.5 | G3/4"X14 | 15 | | 16 | 15 | 29 | 32 | 27 | |
| 1CB-26-08WD | M26X1.5 | G1/2"X14 | 18 | | 14 | 14.5 | 31 | 27 | 32 | |
| 1CB-26-12WD | M26X1.5 | G3/4"X14 | 18 | | 16 | 14.5 | 31 | 32 | 32 | |
| 1CB-30-12WD | M30X2 | G3/4"X14 | 22 | | 16 | 16.5 | 33 | 32 | 36 | 16 轻系列 L |
| 1CB-36-16WD | M36X2 | G1"X11 | 28 | | 18 | 17.5 | 34 | 41 | 41 | |
| 1CB-45-20WD | M45X2 | G1.1/4"X11 | 35 | | 20 | 17.5 | 39 | 50 | 50 | |
| 1CB-52-24WD | M52X2 | G1.1/2"X11 | 42 | | 22 | 19 | 42 | 55 | 60 | |
| 1DB-14-04WD | M14X1.5 | G1/4"X19 | 6 | | 12 | 15 | 30 | 19 | 17 | 63 重系列 S |
| 1DB-16-04WD | M16X1.5 | G1/4"X19 | 8 | | 12 | 15 | 30 | 19 | 19 | |
| 1DB-16-06WD | M16X1.5 | G3/8"X19 | 8 | | 12 | 15.5 | 30 | 22 | 19 | |
| 1DB-18-04WD | M18X1.5 | G1/4"X19 | 10 | | 12 | 14.5 | 31 | 19 | 22 | |
| 1DB-18-06WD | M18X1.5 | G3/8"X19 | 10 | | 12 | 14.5 | 31 | 22 | 22 | |
| 1DB-18-08WD | M18X1.5 | G1/2"X14 | 10 | | 14 | 17.5 | 34 | 27 | 22 | |
| 1DB-20-04WD | M20X1.5 | G1/4"X19 | 12 | | 12 | 15 | 33 | 22 | 24 | |
| 1DB-20-06WD | M20X1.5 | G3/8"X19 | 12 | | 12 | 15 | 33 | 22 | 24 | |
| 1DB-20-08WD | M20X1.5 | G1/2"X14 | 12 | | 14 | 17.8 | 34 | 27 | 24 | |
| 1DB-22-08WD | M22X1.5 | G1/2"X14 | 14 | | 14 | 19 | 37 | 27 | 27 | 40 重系列 S |
| 1DB-24-06WD | M24X1.5 | G3/8"X19 | 16 | | 12 | 18.5 | 36.5 | 27 | 30 | |
| 1DB-24-08WD | M24X1.5 | G1/2"X14 | 16 | | 14 | 18.8 | 37 | 27 | 30 | |
| 1DB-24-12WD | M24X1.5 | G3/4"X14 | 16 | | 16 | 20.5 | 39 | 32 | 30 | |
| 1DB-30-12WD | M30X2 | G3/4"X14 | 20 | | 16 | 20.5 | 42 | 32 | 36 | |
| 1DB-36-08WD | M36X2 | G1/2"X14 | 25 | | 14 | 23 | 47 | 41 | 46 | |
| 1DB-36-12WD | M36X2 | G3/4"X14 | 25 | | 16 | 23 | 47 | 41 | 46 | |
| 1DB-36-16WD | M36X2 | G1"X11 | 25 | | 18 | 23 | 47 | 41 | 46 | |
| 1DB-42-20WD | M42X2 | G1.1/4"X11 | 30 | | 20 | 23.5 | 50 | 50 | 50 | 31.5重系列S |
| 1DB-52-24WD | M52X2 | G1.1/2"X11 | 38 | | 22 | 26 | 57 | 55 | 60 | |

注：如需带卡套及卡套螺母整套订货，则请在代号后加“RN”，如1DB-20-08WDRN。

Note: In case if you are interested to order the adapter in complete set with cutting ring and nut, it is necessary to insert suffix "RN" after our part no., for example 1DB-20-08WDRN.

DIN卡套接头 DIN Bite Type Tube Fittings

B

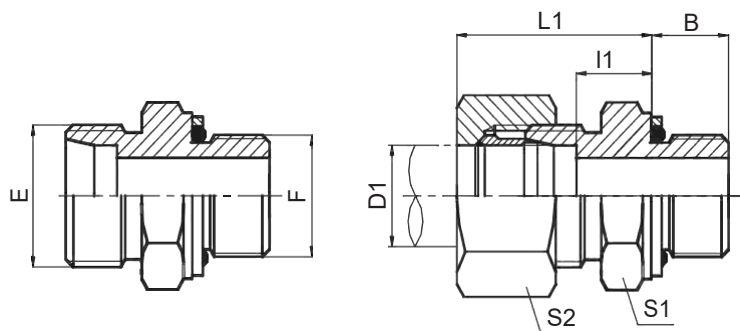

英管螺纹O形圈密封柱端
BSP THREAD STUD ENDS
WITH O-RING SEALING

1CG
1DG

1CG-RN
1DG-RN

| 代号 PART NO. | 螺 纹 THREAD | | 管子外径 TUBE O.D. D1 | 尺 寸 DIMENSIONS | | | | | 压力等级 MPa |
|----------------|------------|------------|----------------------|----------------|------|------|----|----|------------------|
| | E | F | | B | l1 | L1 | S1 | S2 | |
| 1CG-12-02 | M12X1.5 | G1/8"X28 | 6 | 8 | 10 | 23 | 14 | 14 | 31.5 轻系列 L |
| 1CG-12-04 | M12X1.5 | G1/4"X19 | 6 | 11 | 9.5 | 25 | 19 | 14 | |
| 1CG-14-04 | M14x1.5 | G1/4"X19 | 8 | 11 | 10 | 25 | 19 | 17 | |
| 1CG-14-06 | M14x1.5 | G3/8"X19 | 8 | 11.5 | 11.5 | 26 | 24 | 17 | |
| 1CG-14-08 | M14x1.5 | G1/2"X14 | 8 | 14 | 13 | 27.5 | 27 | 17 | |
| 1CG-16-04 | M16x1.5 | G1/4"X19 | 10 | 11 | 12 | 26 | 19 | 19 | |
| 1CG-16-06 | M16x1.5 | G3/8"X19 | 10 | 11.5 | 12.5 | 27 | 24 | 19 | |
| 1CG-16-08 | M16x1.5 | G1/2"X14 | 10 | 14 | 14 | 29 | 27 | 19 | |
| 1CG-18-06 | M18x1.5 | G3/8"X19 | 12 | 11.5 | 12.5 | 27 | 24 | 22 | |
| 1CG-18-08 | M18x1.5 | G1/2"X14 | 12 | 14 | 14 | 28 | 27 | 22 | |
| 1CG-22-06 | M22x1.5 | G3/8"X19 | 15 | 11.5 | 13.5 | 29 | 24 | 27 | |
| 1CG-22-08 | M22x1.5 | G1/2"X14 | 15 | 14 | 15 | 29 | 27 | 27 | |
| 1CG-22-12 | M22x1.5 | G3/4"X14 | 15 | 15.5 | 18.5 | 30 | 36 | 32 | |
| 1CG-26-08 | M26x1.5 | G1/2"X14 | 18 | 14 | 14.5 | 31 | 27 | 32 | |
| 1CG-26-12 | M26x1.5 | G3/4"X14 | 18 | 15.5 | 14.5 | 32 | 36 | 32 | |
| 1CG-30-12 | M30x2 | G3/4"X14 | 22 | 15.5 | 16.5 | 33 | 36 | 36 | |
| 1CG-30-16 | M30x2 | G1"X11 | 22 | 18 | 17.5 | 35 | 41 | 36 | |
| 1CG-36-16 | M36x2 | G1"X11 | 28 | 18 | 17.5 | 34 | 41 | 41 | |
| 1CG-45-20 | M45x2 | G1.1/4"X11 | 35 | 20 | 20.5 | 39 | 50 | 50 | |
| 1CG-52-20 | M52X2 | G1.1/4"X11 | 42 | 20 | 19 | 42 | 55 | 60 | |
| 1CG-52-24 | M52x2 | G1.1/2"X11 | 42 | 21.5 | 19 | 42 | 60 | 60 | |
| 1CG-52-32 | M52x2 | G2"X11 | 42 | 24.5 | 25 | 44 | 70 | 60 | |
| 1DG-14-04 | M14X1.5 | G1/4"X19 | 6 | 11 | 14 | 28 | 19 | 17 | |
| 1DG-16-04 | M16X1.5 | G1/4"X19 | 8 | 11 | 15 | 31 | 19 | 19 | |
| 1DG-18-04 | M18x1.5 | G1/4"X19 | 10 | 11 | 14.5 | 31 | 19 | 22 | |
| 1DG-18-06 | M18x1.5 | G3/8"X19 | 10 | 11.5 | 15 | 31 | 24 | 22 | |
| 1DG-20-06 | M20x1.5 | G3/8"X19 | 12 | 11.5 | 15 | 32 | 24 | 24 | |
| 1DG-20-08 | M20x1.5 | G1/2"X14 | 12 | 14 | 17.5 | 34 | 27 | 24 | |
| 1DG-22-06 | M22x1.5 | G3/8"X19 | 14 | 11.5 | 16 | 37 | 24 | 27 | |
| 1DG-22-08 | M22x1.5 | G1/2"X14 | 14 | 14 | 19 | 37 | 27 | 27 | |
| 1DG-24-04 | M24x1.5 | G1/4"X19 | 16 | 11 | 17 | 37 | 27 | 30 | |
| 1DG-24-08 | M24x1.5 | G1/2"X14 | 16 | 14 | 18.5 | 37 | 27 | 30 | |
| 1DG-30-12 | M30x2 | G3/4"X14 | 20 | 15.5 | 20.5 | 42 | 36 | 36 | |
| 1DG-36-12 | M36x2 | G3/4"X14 | 25 | 15.5 | 23 | 47 | 41 | 46 | |
| 1DG-36-16 | M36x2 | G1"X11 | 25 | 18 | 23 | 47 | 41 | 46 | |
| 1DG-42-16 | M42x2 | G1"X11 | 30 | 18 | 23.5 | 48 | 46 | 50 | |
| 1DG-42-20 | M42x2 | G1.1/4"X11 | 30 | 20 | 23.5 | 50 | 50 | 50 | |
| 1DG-52-24 | M52x2 | G1.1/2"X11 | 38 | 21.5 | 26 | 57 | 60 | 60 | |

注：如需带卡套及卡套螺母整套订货，则请在代号后加“RN”，如1DG-20-08RN。

Note: In case if you are interested to order the adapter in complete set with cutting ring and nut ,it is necessary to insert suffix "RN" after our part no., for example 1DG-20-08RN.

DIN卡套接头 DIN Bite Type Tube Fittings

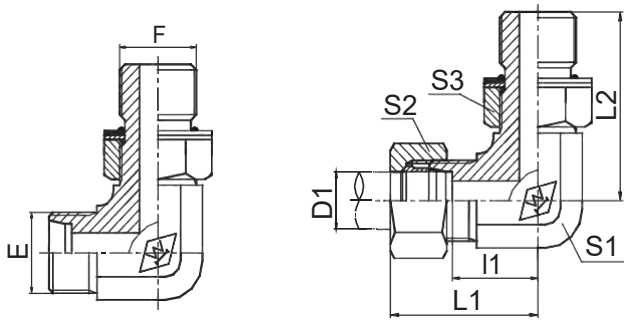

90° 弯英管螺纹可调向O形圈密封柱端
90° ELBOW BSP THREAD ADJUSTABLE
STUD ENDS WITH O-RING SEALING

1CG9-OG
1DG9-OG

1CG9-OGRN
1DG9-OGRN

| 代号 PART NO. | 螺 纹 THREAD | | 管子外径 TUBE O.D. D1 | 尺 寸 DIMENSIONS | | | | | | 压力等级 MPa |
|----------------|------------|------------|----------------------|----------------|------|------|----|----|----|------------------|
| | E | F | | l1 | L1 | L2 | S1 | S2 | S3 | |
| 1CG9-12-02OG | M12X1.5 | G1/8"X28 | 6 | 13 | 28 | 25.5 | 11 | 14 | 14 | 31.5 轻系列 L |
| 1CG9-14-04OG | M14X1.5 | G1/4"X19 | 8 | 15.5 | 30.5 | 31.3 | 14 | 17 | 19 | |
| 1CG9-16-04OG | M16X1.5 | G1/4"X19 | 10 | 17.5 | 32.5 | 32.5 | 16 | 19 | 19 | |
| 1CG9-16-06OG | M16X1.5 | G3/8"X19 | 10 | 17.5 | 32.5 | 35.8 | 16 | 19 | 22 | |
| 1CG9-18-06OG | M18X1.5 | G3/8"X19 | 12 | 19 | 34 | 37 | 19 | 22 | 22 | |
| 1CG9-22-08OG | M22X1.5 | G1/2"X14 | 15 | 22 | 37 | 43.2 | 22 | 27 | 27 | |
| 1CG9-26-08OG | M26X1.5 | G1/2"X14 | 18 | 25.5 | 42 | 46 | 27 | 32 | 27 | |
| 1CG9-26-12OG | M26X1.5 | G3/4"X14 | 18 | 25.5 | 42 | 49.3 | 27 | 32 | 32 | |
| 1CG9-30-12OG | M30X2 | G3/4"X14 | 22 | 29.5 | 45.8 | 52 | 30 | 36 | 32 | |
| 1CG9-30-16OG | M30X2 | G1"X11 | 22 | 31.5 | 48 | 53 | 33 | 36 | 41 | |
| 1CG9-36-16OG | M36X2 | G1"X11 | 28 | 33 | 49.8 | 56 | 36 | 41 | 41 | |
| 1CG9-36-20OG | M36X2 | G1.1/4"X11 | 28 | 36 | 52.8 | 59 | 41 | 41 | 50 | |
| 1CG9-45-20OG | M45X2 | G1.1/4"X11 | 35 | 39 | 60.7 | 63 | 48 | 50 | 50 | |
| 1CG9-52-24OG | M52X2 | G1.1/2"X11 | 42 | 40.5 | 67.8 | 64.5 | 50 | 60 | 55 | 63 重系列 S |
| 1DG9-14-04OG | M14X1.5 | G1/4"X19 | 6 | 17.5 | 32.5 | 31.3 | 14 | 17 | 19 | |
| 1DG9-16-04OG | M16X1.5 | G1/4"X19 | 8 | 18.5 | 33.7 | 32.5 | 16 | 19 | 19 | |
| 1DG9-16-06OG | M16X1.5 | G3/8"X19 | 8 | 18.5 | 33.7 | 35.5 | 16 | 19 | 22 | |
| 1DG9-18-06OG | M18X1.5 | G3/8"X19 | 10 | 19.5 | 36 | 36.8 | 19 | 22 | 22 | |
| 1DG9-20-06OG | M20X1.5 | G3/8"X19 | 12 | 19.5 | 36 | 37 | 19 | 24 | 22 | |
| 1DG9-22-08OG | M22X1.5 | G1/2"X14 | 14 | 26.9 | 41 | 43.2 | 22 | 27 | 27 | 40 重系列 S |
| 1DG9-24-08OG | M24X1.5 | G1/2"X14 | 16 | 24 | 42.5 | 43 | 24 | 30 | 27 | |
| 1DG9-30-12OG | M30X2 | G3/4"X14 | 20 | 28 | 49.5 | 52 | 30 | 36 | 32 | |
| 1DG9-36-16OG | M36X2 | G1"X11 | 25 | 37.5 | 56.8 | 56 | 36 | 46 | 41 | |
| 1DG9-42-20OG | M42X2 | G1.1/4"X11 | 30 | 36 | 62.7 | 59.5 | 41 | 50 | 50 | |
| 1DG9-52-24OG | M52X2 | G1.1/2"X11 | 38 | 41.5 | 76.8 | 63.5 | 55 | 60 | 55 | 31.5重系列S |

注：如需带卡套及卡套螺母整套订货，则请在代号后加“RN”，如1CG9-30-12OGRN。

Note: In case if you are interested to order the adapter in complete set with cutting ring and nut ,it is necessary to insert suffix "RN" after our part no., for example 1CG9-30-12OGRN.

DIN卡套接头 DIN Bite Type Tube Fittings

B

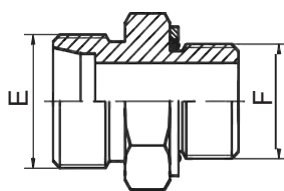

1CH
1DH

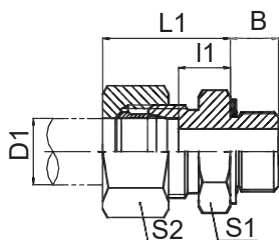

1CH-RN
1DH-RN

公制外螺纹柱端 ISO 6149
METRIC THREAD STUD ENDS
ISO 6149

| 代号 PART NO. | 螺 纹 THREAD | | 管子外径D1 TUBE O.D. | O形圈 O-RING | 尺 寸 DIMENSIONS | | | | | | 压力等级 MPa |
|----------------|---------------|---------|---------------------|---------------|-------------------|------|------|-----|-----|------------------|-------------|
| | E | F | | | B | l1 | L 1 | S 1 | S 2 | | |
| 1CH-12-10 | M12X1.5 | M10X1 | 6 | O08.1X1.6 | 8.5 | 9.5 | 23 | 14 | 14 | 31.5 轻系列 L | |
| 1CH-14 | M14X1.5 | M14X1.5 | 8 | O11.3X2.4 | 11 | 10 | 25 | 19 | 17 | | |
| 1CH-14-12 | M14X1.5 | M12X1.5 | 8 | O09.3X2.4 | 11 | 10 | 25 | 17 | 17 | | |
| 1CH-16-14 | M16X1.5 | M14X1.5 | 10 | O11.3X2.4 | 11 | 13 | 26 | 19 | 19 | | |
| 1CH-18-14 | M18X1.5 | M14X1.5 | 12 | O11.3X2.4 | 11 | 11 | 25.5 | 19 | 22 | | |
| 1CH-14-18 | M14X1.5 | M18X1.5 | 8 | O15.3X2.4 | 12.5 | 11.5 | 26.5 | 24 | 17 | | |
| 1CH-16 | M16X1.5 | M16X1.5 | 10 | O13.3X2.4 | 11.5 | 12.5 | 28 | 22 | 19 | | |
| 1CH-16-18 | M16X1.5 | M18X1.5 | 10 | O15.3X2.4 | 12.5 | 12.5 | 28 | 24 | 19 | | |
| 1CH-18-16 | M18X1.5 | M16X1.5 | 12 | O13.3X2.4 | 11.5 | 12.5 | 27 | 22 | 22 | | |
| 1CH-22-16 | M22X1.5 | M16X1.5 | 15 | O13.3X2.4 | 11.5 | 13.5 | 29.5 | 24 | 27 | | |
| 1CH-22-18 | M22X1.5 | M18X1.5 | 15 | O15.3X2.4 | 12.5 | 13.5 | 29 | 24 | 27 | | |
| 1CH-16-22 | M16X1.5 | M22X1.5 | 10 | O19.3X2.4 | 13 | 13.5 | 29.5 | 27 | 19 | | |
| 1CH-22-20 | M22X1.5 | M20X1.5 | 15 | O17.3X2.4 | 12 | 15 | 30.5 | 27 | 27 | | |
| 1CH-22 | M22X1.5 | M22X1.5 | 15 | O19.3X2.4 | 13 | 15 | 31 | 27 | 27 | | |
| 1CH-26-22 | M26X1.5 | M22X1.5 | 18 | O19.3X2.4 | 13 | 14.5 | 31 | 27 | 32 | | |
| 1CH-26 | M26X1.5 | M26X1.5 | 18 | O23.5X3.0 | 13.5 | 14.5 | 31 | 32 | 32 | | |
| 1CH-26-27 | M26X1.5 | M27X2 | 18 | O23.5X3.0 | 16 | 14.5 | 32 | 32 | 32 | | |
| 1CH-26-33 | M26X1.5 | M33X2 | 18 | O29.5X3.0 | 16 | 15.5 | 33 | 41 | 32 | | |
| 1CH-30-22 | M30X2 | M22X1.5 | 22 | O19.3X2.4 | 13 | 16.5 | 33 | 32 | 41 | | |
| 1CH-30-27 | M30X2 | M27X2 | 22 | O23.5X3.0 | 16 | 16.5 | 33 | 32 | 36 | | |
| 1CH-30 | M30X2 | M30X2 | 22 | O26.5X3.0 | 16 | 17.5 | 33 | 36 | 36 | | |
| 1CH-36-27 | M36X2 | M27X2 | 28 | O23.5X3.0 | 16 | 17 | 34 | 41 | 41 | | |
| 1CH-36-33 | M36X2 | M33X2 | 28 | O29.5X3.0 | 16 | 17.5 | 34 | 41 | 41 | | |
| 1CH-36-42 | M36X2 | M42X2 | 28 | O38.5X3.0 | 16 | 18.5 | 35 | 50 | 41 | | |
| 1CH-45-33 | M45X2 | M33X2 | 35 | O29.5X3.0 | 16 | 17.5 | 37 | 46 | 50 | | |
| 1CH-45-42 | M45X2 | M42X2 | 35 | O38.5X3.0 | 16 | 17.5 | 37 | 50 | 50 | | |
| 1CH-52-48 | M52X2 | M48X2 | 42 | O44.5X3.0 | 17.5 | 19 | 40 | 55 | 60 | | |
| 1DH-14 | M14X1.5 | M14X1.5 | 6 | O11.3X2.4 | 11 | 15 | 28 | 19 | 17 | | |
| 1DH-14-12 | M14X1.5 | M12X1.5 | 6 | O09.3X2.4 | 11 | 13 | 28 | 17 | 17 | | |
| 1DH-16-14 | M16X1.5 | M14X1.5 | 8 | O11.3X2.4 | 11 | 15 | 30 | 19 | 19 | | |
| 1DH-18-16 | M18X1.5 | M16X1.5 | 10 | O13.3X2.4 | 11.5 | 15 | 31 | 22 | 22 | | |
| 1DH-20-14 | M20X1.5 | M14X1.5 | 12 | O11.3X2.4 | 11 | 15 | 31 | 22 | 24 | | |
| 1DH-20-16 | M20X1.5 | M16X1.5 | 12 | O13.3X2.4 | 11.5 | 15 | 31 | 22 | 24 | | |
| 1DH-20-18 | M20X1.5 | M18X1.5 | 12 | O15.3X2.4 | 12.5 | 17 | 33 | 24 | 24 | | |
| 1DH-20-22 | M20X1.5 | M22X1.5 | 12 | O19.3X2.4 | 13 | 17.5 | 35 | 27 | 30 | | |
| 1DH-24-22 | M24X1.5 | M22X1.5 | 16 | O19.3X2.4 | 13 | 18.5 | 37 | 27 | 30 | | |
| 1DH-30 | M30X2 | M30X2 | 20 | O26.5X3.0 | 16 | 20.5 | 42 | 36 | 36 | | |
| 1DH-30-27 | M30X2 | M27X2 | 20 | O23.5X3.0 | 16 | 20.5 | 42 | 32 | 36 | | |
| 1DH-30-33 | M30X2 | M33X2 | 20 | O29.5X3.0 | 16 | 22.5 | 42 | 41 | 36 | | |
| 1DH-36-27 | M36X2 | M27X2 | 25 | O23.5X3.0 | 16 | 23 | 47 | 41 | 46 | | |
| 1DH-36-33 | M36X2 | M33X2 | 25 | O29.5X3.0 | 16 | 23 | 47 | 41 | 46 | | |
| 1DH-42 | M42X2 | M42X2 | 30 | O38.5X3.0 | 16 | 23.5 | 50 | 50 | 50 | | |
| 1DH-42-48 | M42X2 | M48X2 | 30 | O44.5X3.0 | 17.5 | 26.5 | 52 | 55 | 50 | | |

注：如需带卡套及卡套螺母整套订货，则请在代号后加“RN”，如1DH-20-18RN。

Note: In case if you are interested to order the adapter in complete set with cutting ring and nut, it is necessary to insert suffix "RN" after our part NO., for example 1DH-20-18RN.

DIN卡套接头 DIN Bite Type Tube Fittings

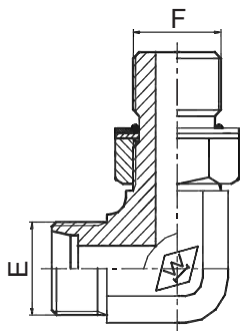

1CH9-OG
1DH9-OG

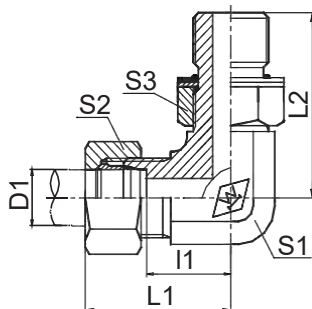

1CH9-OGRN
1DH9-OGRN

90° 弯公制外螺纹可调向柱端 ISO 6149
90° ELBOW METRIC THREAD
ADJUSTABLE STUD ENDS ISO 6149

| 代号 PART NO. | 螺 纹 THREAD | | 管子外径D1 TUBE O.D. | O形圈 O-RING | 尺 寸 DIMENSIONS | | | | | | 压力等级 MPa |
|----------------|------------|---------|---------------------|---------------|----------------|------|------|----|----|----|------------------|
| | E | F | | | I1 | L1 | L2 | S1 | S2 | S3 | |
| 1CH9-12-10OG | M12X1.5 | M10X1 | 6 | O08.1X1.6 | 13 | 28 | 26.5 | 11 | 14 | 14 | 31.5 轻系列 L |
| 1CH9-14-12OG | M14X1.5 | M12X1.5 | 8 | O09.3X2.4 | 15.5 | 30.5 | 32 | 14 | 17 | 17 | |
| 1CH9-16-14OG | M16X1.5 | M14X1.5 | 10 | O11.3X2.4 | 17.5 | 32.5 | 34 | 16 | 19 | 19 | |
| 1CH9-18-16OG | M18X1.5 | M16X1.5 | 12 | O13.3X2.4 | 19 | 34 | 36 | 19 | 22 | 22 | |
| 1CH9-22-18OG | M22X1.5 | M18X1.5 | 15 | O15.3X2.4 | 22 | 37 | 39.5 | 22 | 27 | 24 | |
| 1CH9-26-22OG | M26X1.5 | M22X1.5 | 18 | O19.3X2.4 | 25.5 | 42 | 43.5 | 27 | 32 | 27 | |
| 1CH9-30-27OG | M30X2 | M27X2 | 22 | O23.5X3.0 | 29.5 | 45.8 | 50 | 30 | 36 | 32 | 16 轻系列L |
| 1CH9-36-33OG | M36X2 | M33X2 | 28 | O29.5X3.0 | 33.3 | 49.8 | 54 | 36 | 41 | 41 | |
| 1DH9-14-12OG | M14X1.5 | M12X1.5 | 6 | O09.3X2.4 | 17.5 | 32.5 | 32 | 14 | 17 | 17 | 63 重系列 S |
| 1DH9-16-14OG | M16X1.5 | M14X1.5 | 8 | O11.3X2.4 | 18.5 | 33.7 | 34 | 16 | 19 | 19 | |
| 1DH9-18-16OG | M18X1.5 | M16X1.5 | 10 | O13.3X2.4 | 19.5 | 36 | 36 | 19 | 22 | 22 | |
| 1DH9-20-18OG | M20X1.5 | M18X1.5 | 12 | O15.3X2.4 | 22.7 | 36 | 37 | 19 | 24 | 24 | |
| 1DH9-22-20OG | M22X1.5 | M20X1.5 | 14 | O17.3X2.4 | 23.5 | 41 | 40.5 | 22 | 27 | 27 | |
| 1DH9-24-22OG | M24X1.5 | M22X1.5 | 16 | O19.3X2.4 | 24 | 42 | 41 | 24 | 30 | 27 | |
| 1DH9-30-27OG | M30X2 | M27X2 | 20 | O23.5X3.0 | 32.9 | 49.8 | 50 | 30 | 36 | 32 | 40 重系列 S |
| 1DH9-36-33OG | M36X2 | M33X2 | 25 | O29.5X3.0 | 32.8 | 56.8 | 54 | 36 | 46 | 41 | |
| 1DH9-42OG | M42X2 | M42X2 | 30 | O38.5X3.0 | 36 | 62.7 | 57.2 | 41 | 50 | 50 | |

注：如需带卡套及卡套螺母整套订货，则请在代号后加“RN”，如1DH9-20-18OGRN。

Note: In case if you are interested to order the adapter in complete set with cutting ring and nut, it is necessary to insert suffix "RN" after our part NO., for example 1DH9-20-18OGRN.

DIN卡套接头 DIN Bite Type Tube Fittings

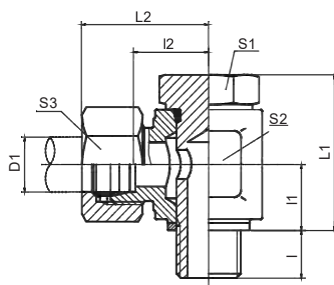
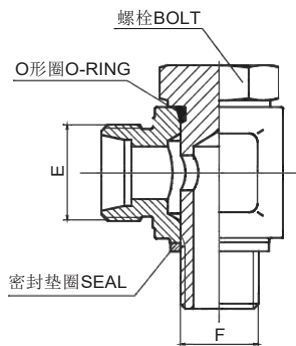

公制螺纹铰接接头
METRIC BANJO

1CI
1DI

1CI-RN
1DI-RN

| 代号 PART NO. | 螺纹 THREAD | | 管子外径D1 TUBE O.D. | 尺寸 DIMENSIONS | | | | | | | | | 螺栓 BOLT | O形圈 O-RING | 密封垫圈 SEAL | 压力等级 MPa |
|----------------|-----------|---------|---------------------|---------------|------|------|------|----|----|----|----|----------|------------|---------------|------------------|-------------|
| | E | F | | l | l1 | L1 | l2 | L2 | S1 | S2 | S3 | | | | | |
| 1CI-12-10 | M12X1.5 | M10X1 | 6 | 10 | 9 | 25.5 | 12 | 27 | 14 | 17 | 14 | 700M-10I | O08.1X1.6 | ZHD-10 | 31.5 轻系列 L | |
| 1CI-14-12 | M14X1.5 | M12X1.5 | 8 | 12 | 14.5 | 33 | 14.5 | 29 | 17 | 22 | 17 | 700M-12I | O09.3X2.4 | ZHD-12 | | |
| 1CI-16-14 | M16X1.5 | M14X1.5 | 10 | 11 | 12.5 | 33 | 16.5 | 31 | 19 | 24 | 19 | 700M-14I | O11.3X2.4 | ZHD-14 | | |
| 1CI-18-16 | M18X1.5 | M16X1.5 | 12 | 11 | 15 | 39 | 19 | 34 | 22 | 27 | 22 | 700M-16I | O13.3X2.4 | ZHD-16 | | |
| 1CI-22-18 | M22X1.5 | M18X1.5 | 15 | 12 | 16.5 | 42 | 21.5 | 37 | 24 | 30 | 27 | 700M-18I | O15.3X2.4 | ZHD-18 | | |
| 1CI-26-22 | M26X1.5 | M22X1.5 | 18 | 12 | 17.5 | 49 | 22 | 38 | 27 | 32 | 32 | 700M-22I | O19.3X2.4 | ZHD-22 | | |
| 1CI-30-26 | M30X2 | M26X1.5 | 22 | 14 | 22 | 56 | 28.5 | 45 | 36 | 41 | 36 | 700M-26I | O23.5X3.0 | ZHD-27 | 16 轻系列 L | |
| 1CI-36-33 | M36X2 | M33X2 | 28 | 18 | 30.5 | 71 | 33 | 50 | 41 | 50 | 41 | 700M-33I | O29.5X3.0 | ZHD-33 | | |
| 1CI-45-42 | M45X2 | M42X2 | 35 | 20 | 35.5 | 82 | 37 | 59 | 50 | 60 | 50 | 700M-42I | O38.5X3.0 | ZHD-42 | | |
| 1CI-52-48 | M52X2 | M48X2 | 42 | 22 | 40.5 | 93 | 41.5 | 64 | 55 | 70 | 60 | 700M-48I | O44.5X3.0 | ZHD-48 | | |
| 1DI-14-12 | M14X1.5 | M12X1.5 | 6 | 12 | 14.5 | 33 | 16.5 | 31 | 17 | 22 | 17 | 700M-12I | O09.3X2.4 | ZHD-12 | 63 重系列 S | |
| 1DI-16-14 | M16X1.5 | M14X1.5 | 8 | 12 | 14.5 | 33 | 17.5 | 32 | 19 | 24 | 19 | 700M-14I | O11.3X2.4 | ZHD-14 | | |
| 1DI-18-16 | M18X1.5 | M16X1.5 | 10 | 12 | 17 | 39 | 19.5 | 36 | 22 | 27 | 22 | 700M-16I | O13.3X2.4 | ZHD-16 | | |
| 1DI-20-18 | M20X1.5 | M18X1.5 | 12 | 12 | 18.5 | 42 | 21 | 37 | 24 | 30 | 24 | 700M-18I | O15.3X2.4 | ZHD-18 | | |
| 1DI-22-20 | M22X1.5 | M20X1.5 | 14 | 14 | 20 | 46 | 23.5 | 41 | 27 | 32 | 27 | 700M-20I | O17.3X2.4 | ZHD-20 | | |
| 1DI-24-22 | M24X1.5 | M22X1.5 | 16 | 14 | 17.5 | 49 | 23 | 41 | 27 | 32 | 30 | 700M-22I | O19.3X2.4 | ZHD-22 | | |
| 1DI-30-27 | M30X2 | M27X2 | 20 | 16 | 22 | 56 | 27.5 | 49 | 36 | 41 | 36 | 700M-27I | O23.5X3.0 | ZHD-27 | 40 重系列 S | |
| 1DI-36-33 | M36X2 | M33X2 | 25 | 18 | 30.5 | 71 | 32.5 | 57 | 41 | 50 | 46 | 700M-33I | O29.5X3.0 | ZHD-33 | | |
| 1DI-42 | M42X2 | M42X2 | 30 | 20 | 35.5 | 82 | 38 | 65 | 50 | 60 | 50 | 700M-42I | O38.5X3.0 | ZHD-42 | | |
| 1DI-52-48 | M52X2 | M48X2 | 38 | 22 | 40.5 | 93 | 42.5 | 73 | 55 | 70 | 60 | 700M-48I | O44.5X3.0 | ZHD-48 | | |

注: 1.如需带卡套及卡套螺母整套订货, 则请在代号后加 "RN", 如1DI-36-33RN。

Note: 1. In case if you are interested to order the adapter in complete set with cutting ring and nut, it is necessary to insert suffix "RN" after our part no., for example 1DI-36-33RN.

DIN卡套接头 DIN Bite Type Tube Fittings

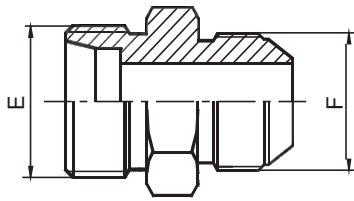

1CJ
1DJ

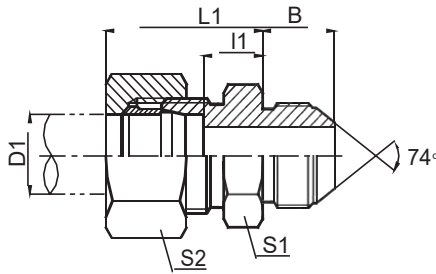

1CJ-RN
1DJ-RN

美制JIC 74° 锥密封
JIC 74° CONE SEALING

| 代号 PART NO. | 螺 纹 THREAD | | 管子外径 TUBE O.D. | 尺 寸 DIMENSIONS | | | | | | 压力等级 MPa |
|----------------|---------------|------------|-------------------|-------------------|------|----|----|----|------------------|-------------|
| | E | F | | D1 | B | l1 | L1 | S1 | S2 | |
| 1CJ-10-04LL | M10x1 | 7/16"X20 | 6 | 14 | 7.5 | 20 | 12 | 12 | 31.5 轻系列 L | |
| 1CJ-12A-04LL | M12x1 | 7/16"X20 | 8 | 14 | 8.5 | 22 | 12 | 14 | | |
| 1CJ-12-04 | M12x1.5 | 7/16"X20 | 6 | 14 | 8 | 24 | 12 | 14 | | |
| 1CJ-14-04 | M14x1.5 | 7/16"X20 | 8 | 14 | 8 | 23 | 14 | 17 | | |
| 1CJ-14-06 | M14x1.5 | 9/16"X18 | 8 | 14.1 | 8 | 23 | 17 | 17 | | |
| 1CJ-16-06 | M16x1.5 | 9/16"X18 | 10 | 14.1 | 9 | 24 | 17 | 19 | | |
| 1CJ-18-06 | M18x1.5 | 9/16"X18 | 12 | 14.1 | 10 | 25 | 19 | 22 | | |
| 1CJ-18-08 | M18x1.5 | 3/4"X16 | 12 | 16.7 | 10.3 | 25 | 22 | 22 | | |
| 1CJ-22-08 | M22x1.5 | 3/4"X16 | 15 | 16.7 | 10.8 | 26 | 24 | 27 | | |
| 1CJ-22-10 | M22x1.5 | 7/8"X14 | 15 | 19.3 | 11 | 26 | 24 | 27 | | |
| 1CJ-26-10 | M26X1.5 | 7/8"X14 | 18 | 19.3 | 11.5 | 28 | 27 | 32 | | |
| 1CJ-26-12 | M26X1.5 | 1.1/16"X12 | 18 | 21.9 | 11.6 | 28 | 30 | 32 | | |
| 1CJ-30-12 | M30x2 | 1.1/16"X12 | 22 | 21.9 | 13.5 | 30 | 32 | 36 | | |
| 1CJ-30D-12 | M30X1.5 | 1.1/16"X12 | 22 | 21.9 | 17.6 | 30 | 32 | 36 | | |
| 1CJ-30D-16 | M30X1.5 | 1.5/16"X12 | 22 | 23.1 | 17.4 | 31 | 36 | 36 | | |
| 1CJ-36-16 | M36x2 | 1.5/16"X12 | 28 | 23.1 | 14.5 | 31 | 41 | 41 | | |
| 1CJ-36D-12 | M36X1.5 | 1.1/16"X12 | 28 | 21.9 | 19.6 | 31 | 41 | 41 | | |
| 1CJ-36D-16 | M36X1.5 | 1.5/16"X12 | 28 | 23.1 | 19.4 | 31 | 41 | 41 | | |
| 1CJ-45-20 | M45X2 | 1.5/8"X12 | 35 | 24.3 | 14.7 | 36 | 46 | 50 | | |
| 1CJ-45D-20 | M45X1.5 | 1.5/8"X12 | 35 | 24.3 | 19.7 | 37 | 46 | 50 | | |
| 1CJ-52-20 | M52X2 | 1.5/8"X12 | 42 | 24.3 | 16 | 39 | 55 | 60 | | |
| 1CJ-52-24 | M52X2 | 1.7/8"X12 | 42 | 27.5 | 16 | 39 | 55 | 60 | | |
| 1DJ-14-04 | M14x1.5 | 7/16"X20 | 6 | 14 | 11 | 26 | 14 | 14 | | |
| 1DJ-16-04 | M16x1.5 | 7/16"X20 | 8 | 14 | 13 | 28 | 17 | 19 | | |
| 1DJ-16-06 | M16x1.5 | 9/16"X18 | 8 | 14.1 | 12.9 | 28 | 17 | 19 | | |
| 1DJ-18-04 | M18x1.5 | 7/16"X20 | 10 | 14 | 12.5 | 29 | 19 | 22 | | |
| 1DJ-18-06 | M18x1.5 | 9/16"X18 | 10 | 14.1 | 12.4 | 29 | 19 | 22 | | |
| 1DJ-20-06 | M20x1.5 | 9/16"X18 | 12 | 14.1 | 14.4 | 31 | 22 | 24 | | |
| 1DJ-20-08 | M20x1.5 | 3/4"X16 | 12 | 16.7 | 14.3 | 31 | 22 | 24 | | |
| 1DJ-22-08 | M22x1.5 | 3/4"X16 | 14 | 16.7 | 16 | 34 | 24 | 27 | | |
| 1DJ-24-08 | M24x1.5 | 3/4"X16 | 16 | 16.7 | 15.5 | 34 | 27 | 30 | | |
| 1DJ-24-10 | M24x1.5 | 7/8"X14 | 16 | 19.3 | 15.5 | 34 | 27 | 30 | | |
| 1DJ-30-12 | M30x2 | 1.1/16"X12 | 20 | 21.9 | 17.5 | 39 | 32 | 36 | | |
| 1DJ-36-12 | M36x2 | 1.1/16"X12 | 25 | 21.9 | 20.1 | 43 | 41 | 46 | | |
| 1DJ-36-16 | M36x2 | 1.5/16"X12 | 25 | 23.1 | 20 | 43 | 41 | 46 | | |
| 1DJ-42-20 | M42x2 | 1.5/8"X12 | 30 | 24.3 | 20.5 | 47 | 46 | 50 | | |
| 1DJ-52-24 | M52X2 | 1.7/8"X12 | 38 | 27.5 | 23 | 54 | 55 | 60 | | |

注：如需带卡套及卡套螺母整套订货，则请在代号后加“RN”，如1DJ-20-08RN。

Note: In case if you are interested to order the adapter in complete set with cutting ring and nut ,it is necessary to insert suffix "RN" after our part no., for example 1DJ-20-08RN.

DIN卡套接头 DIN Bite Type Tube Fittings

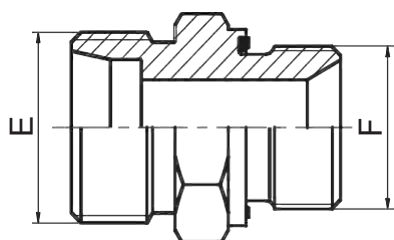

1CM-WD
1DM-WD

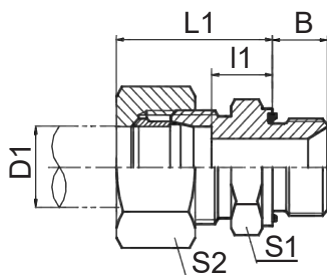

1CM-WDRN
1DM-WDRN

公制螺纹胶垫密封柱端
METRIC THREAD WITH
CAPTIVE SEAL

| 代号 PART NO. | 螺 纹 THREAD | | 管子外径 TUBE O.D. | | 尺 寸 DIMENSIONS | | | | | 压力等级 MPa |
|----------------|------------|---------|----------------|--|----------------|------|----|----|----|------------------|
| | E | F | D1 | | B | l1 | L1 | S1 | S2 | |
| 1CM-12-10WD | M12X1.5 | M10X1 | 6 | | 8 | 9.5 | 23 | 14 | 14 | 31.5 轻系列 L |
| 1CM-14-12WD | M14X1.5 | M12X1.5 | 8 | | 12 | 10.5 | 25 | 17 | 17 | |
| 1CM-16-12WD | M16X1.5 | M12X1.5 | 10 | | 12 | 11 | 25 | 17 | 19 | |
| 1CM-16-14WD | M16X1.5 | M14X1.5 | 10 | | 12 | 10 | 26 | 19 | 19 | |
| 1CM-16-18WD | M16X1.5 | M18X1.5 | 10 | | 12 | 12.5 | 27 | 24 | 19 | |
| 1CM-18-16WD | M18X1.5 | M16X1.5 | 12 | | 12 | 12.5 | 27 | 22 | 22 | |
| 1CM-18WD | M18X1.5 | M18X1.5 | 12 | | 12 | 12.5 | 27 | 24 | 22 | |
| 1CM-18-22WD | M18X1.5 | M22X1.5 | 12 | | 14 | 14 | 29 | 27 | 22 | |
| 1CM-22-18WD | M22X1.5 | M18X1.5 | 15 | | 12 | 14 | 29 | 24 | 27 | |
| 1CM-22WD | M22X1.5 | M22X1.5 | 15 | | 14 | 15 | 30 | 27 | 27 | |
| 1CM-26-22WD | M26X1.5 | M22X1.5 | 18 | | 14 | 14.8 | 31 | 27 | 32 | |
| 1CM-30-26WD | M30X2 | M26X1.5 | 22 | | 16 | 16.5 | 33 | 32 | 36 | |
| 1CM-30-27WD | M30X2 | M27X2 | 22 | | 16 | 16.5 | 33 | 32 | 36 | |
| 1CM-36-33WD | M36X2 | M33X2 | 28 | | 18 | 17.5 | 34 | 41 | 41 | |
| 1CM-45-42WD | M45X2 | M42X2 | 35 | | 20 | 17.5 | 39 | 50 | 50 | |
| 1CM-52-48WD | M52X2 | M48X2 | 42 | | 22 | 20 | 42 | 55 | 60 | |
| 1DM-14-12WD | M14X1.5 | M12X1.5 | 6 | | 10 | 12 | 28 | 17 | 17 | |
| 1DM-16-14WD | M16X1.5 | M14X1.5 | 8 | | 11 | 13 | 30 | 19 | 19 | |
| 1DM-18-16WD | M18X1.5 | M16X1.5 | 10 | | 12 | 15 | 31 | 22 | 22 | |
| 1DM-20-18WD | M20X1.5 | M18X1.5 | 12 | | 12 | 17 | 33 | 24 | 24 | |
| 1DM-22-20WD | M22X1.5 | M20X1.5 | 14 | | 14 | 19 | 37 | 27 | 27 | |
| 1DM-24-22WD | M24X1.5 | M22X1.5 | 16 | | 14 | 16.5 | 37 | 27 | 30 | |
| 1DM-30-27WD | M30X2 | M27X2 | 20 | | 16 | 20.5 | 42 | 32 | 36 | |
| 1DM-36-33WD | M36X2 | M33X2 | 25 | | 18 | 23 | 47 | 41 | 46 | |
| 1DM-42WD | M42X2 | M42X2 | 30 | | 20 | 23.5 | 50 | 50 | 50 | |
| 1DM-52-48WD | M52X2 | M48X2 | 38 | | 22 | 26 | 57 | 55 | 60 | |
| | | | | | | | | | | 31.5重系列S |

注：如需带卡套及卡套螺母整套订货，则请在代号后加“RN”，如1DM-20-18WDRN。

Note: In case if you are interested to order the adapter in complete set with cutting ring and nut ,it is necessary to insert suffix "RN" after our part no., for example 1DM-20-18WDRN.

DIN卡套接头 DIN Bite Type Tube Fittings

B

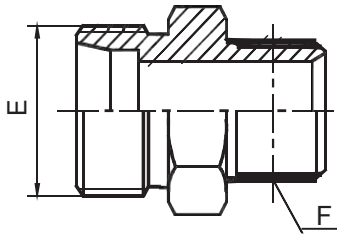

**1CN
1DN**

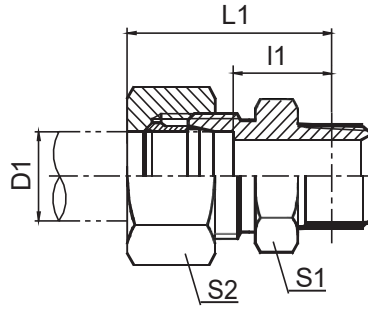

**1CN-RN
1DN-RN**

布锥管外螺纹
NPT MALE

| 代号 PART NO. | 螺 纹 THREAD | | 管子外径 TUBE O.D. D1 | 尺 寸 DIMENSIONS | | | | 压力等级 MPa |
|----------------|------------|--------------|----------------------|----------------|------|----|----|------------------|
| | E | F | | l1 | L1 | S1 | S2 | |
| 1CN-08-02 | M8X1 | Z1/8"X27 | 4 | 14.4 | 24.4 | 12 | 10 | 10 特轻系列 LL |
| 1CN-10-02LL | M10X1 | Z1/8"X27 | 6 | 13.9 | 24.4 | 12 | 12 | |
| 1CN-12-02LL | M12X1 | Z1/8"X27 | 8 | 14.9 | 25.4 | 12 | 14 | |
| 1CN-12-02 | M12X1.5 | Z1/8"X27 | 6 | 14.4 | 28.4 | 12 | 14 | 25 轻系列 L |
| 1CN-12-04 | M12X1.5 | Z1/4"X18 | 6 | 17.2 | 32.2 | 17 | 14 | |
| 1CN-14-04 | M14X1.5 | Z1/4"X18 | 8 | 17.2 | 32.2 | 14 | 17 | |
| 1CN-16-04 | M16X1.5 | Z1/4"X18 | 10 | 18.2 | 33.2 | 17 | 19 | |
| 1CN-16-06 | M16X1.5 | Z3/8"X18 | 10 | 19.9 | 53.0 | 19 | 19 | |
| 1CN-18-04 | M18X1.5 | Z1/4"X18 | 12 | 19.2 | 34.2 | 19 | 22 | |
| 1CN-18-06 | M18X1.5 | Z3/8"X18 | 12 | 19.9 | 34.9 | 19 | 22 | |
| 1CN-18-08 | M18X1.5 | Z1/2"X14 | 12 | 21.4 | 36.4 | 22 | 22 | |
| 1CN-22-08 | M22X1.5 | Z1/2"X14 | 15 | 22.4 | 37.4 | 24 | 27 | |
| 1CN-22-20 | M22X1.5 | Z1.1/4"X11.5 | 15 | 29.8 | 37.4 | 46 | 27 | |
| 1CN-26-08 | M26X1.5 | Z1/2"X14 | 18 | 22.9 | 39.4 | 27 | 32 | 16 轻系列 L |
| 1CN-26-12 | M26X1.5 | Z3/4"X14 | 18 | 22.4 | 38.9 | 30 | 32 | |
| 1CN-30-08 | M30X2 | Z1/2"X14 | 22 | 24.9 | 40.5 | 32 | 36 | |
| 1CN-30-12 | M30X2 | Z3/4"X14 | 22 | 24.4 | 40.9 | 32 | 36 | |
| 1CN-36-16 | M36X2 | Z1"X11.5 | 28 | 29.8 | 46.3 | 41 | 41 | |
| 1CN-36-20 | M36X2 | Z1.1/4"X11.5 | 28 | 31.3 | 46.3 | 46 | 41 | |
| 1CN-45-20 | M45X2 | Z1.1/4"X11.5 | 35 | 30.3 | 51.8 | 46 | 50 | |
| 1CN-52-20 | M52X2 | Z1.1/4"X11.5 | 42 | 31.8 | 55.8 | 55 | 60 | |
| 1CN-52-24 | M52X2 | Z1.1/2"X11.5 | 42 | 32.8 | 55.8 | 55 | 60 | |
| 1DN-14-04 | M14X1.5 | Z1/4"X18 | 6 | 22.2 | 37.2 | 17 | 17 | 40 重系列 S |
| 1DN-16-04 | M16X1.5 | Z1/4"X18 | 8 | 22.2 | 37.2 | 17 | 19 | |
| 1DN-18-04 | M18X1.5 | Z1/4"X18 | 10 | 21.7 | 38.2 | 19 | 22 | |
| 1DN-18-06 | M18X1.5 | Z3/8"X18 | 10 | 22.4 | 38.9 | 19 | 22 | |
| 1DN-20-04 | M20X1.5 | Z1/4"X18 | 12 | 23.7 | 40.2 | 22 | 24 | |
| 1DN-20-06 | M20X1.5 | Z3/8"X18 | 12 | 24.4 | 40.9 | 22 | 24 | |
| 1DN-20-08 | M20X1.5 | Z1/2"X14 | 12 | 26.4 | 42.4 | 22 | 24 | |
| 1DN-22-08 | M22X1.5 | Z1/2"X14 | 14 | 27.4 | 45.4 | 24 | 27 | |
| 1DN-24-08 | M24X1.5 | Z1/2"X14 | 16 | 26.9 | 45.4 | 27 | 30 | |
| 1DN-30-12 | M30X2 | Z3/4"X14 | 20 | 28.4 | 49.9 | 32 | 36 | 25 重系列 S |
| 1DN-36-12 | M36X2 | Z3/4"X14 | 25 | 30.9 | 59.3 | 41 | 46 | |
| 1DN-36-16 | M36X2 | Z1"X11.5 | 25 | 35.3 | 59.3 | 41 | 46 | |
| 1DN-42-16 | M42X2 | Z1"X11.5 | 25 | 35.8 | 59.3 | 46 | 46 | |
| 1DN-42-20 | M42X2 | Z1.1/4"X11.5 | 30 | 36.3 | 62.8 | 46 | 50 | |
| 1DN-52-24 | M52X2 | Z1.1/2"X11.5 | 38 | 39.8 | 70.8 | 55 | 60 | |

注：如需带卡套及卡套螺母整套订货，则请在代号后加“RN”，如1DN-30-12RN。

Note: In case if you are interested to order the adapter in complete set with cutting ring and nut ,it is necessary to insert suffix "RN" after our part no. , for example 1DN-30-12RN.

DIN卡套接头 DIN Bite Type Tube Fittings

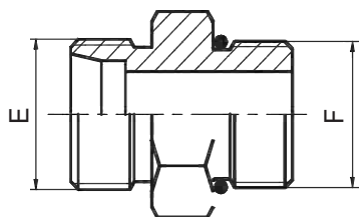

1CO
1DO

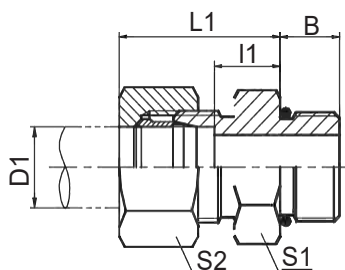

1CO-RN
1DO-RN

美制螺纹O形圈密封柱端
UN、UNF THREAD STUD ENDS
WITH O-RING SEALING

| 代号 PART NO. | 螺 纹 THREAD | | 管子外径 TUBE O.D. | | 尺 寸 DIMENSIONS | | | | | | 压力等级 MPa |
|----------------|------------|------------|----------------|--|----------------|-------|------|----|----|--|------------------|
| | E | F | D1 | | B | I 1 | L1 | S1 | S2 | | |
| 1CO-14-04 | M14X1.5 | 7/16"X20 | 8 | | 9 | 8.5 | 25 | 14 | 17 | | 31.5 轻系列 L |
| 1CO-16-04 | M16X1.5 | 7/16"X20 | 10 | | 9 | 9.5 | 26 | 17 | 19 | | |
| 1CO-18-06 | M18X1.5 | 9/16"X18 | 12 | | 10 | 10 | 26 | 19 | 22 | | |
| 1CO-18-08 | M18X1.5 | 3/4"X16 | 12 | | 11 | 10.5 | 28 | 22 | 22 | | |
| 1CO-18-10 | M18X1.5 | 7/8"X14 | 12 | | 12.7 | 13.8 | 29 | 27 | 22 | | |
| 1CO-22-08 | M22X1.5 | 3/4"X16 | 15 | | 11 | 15 | 29 | 24 | 27 | | |
| 1CO-22-10 | M22X1.5 | 7/8"X14 | 15 | | 12.7 | 12.3 | 30 | 27 | 27 | | |
| 1CO-22-12 | M22X1.5 | 1.1/16"X12 | 15 | | 15.09 | 11.91 | 30 | 32 | 27 | | |
| 1CO-26-08 | M26X1.5 | 3/4"X16 | 18 | | 11 | 15 | 31 | 27 | 32 | | |
| 1CO-26-10 | M26X1.5 | 7/8"X14 | 18 | | 12.7 | 11.5 | 31 | 27 | 32 | | |
| 1CO-30-08 | M30X2 | 3/4"X16 | 18 | | 11.13 | 17.37 | 33 | 32 | 36 | | 16 轻系列 L |
| 1CO-30-10 | M30X2 | 7/8"X14 | 22 | | 12.7 | 17.3 | 33 | 32 | 36 | | |
| 1CO-30-12 | M30X2 | 1.1/16"X12 | 22 | | 15 | 13.5 | 33 | 32 | 36 | | |
| 1CO-30-16 | M30X2 | 1.5/16"X12 | 22 | | 15 | 14.5 | 34 | 38 | 36 | | |
| 1CO-36-12 | M36X2 | 1.1/16"X12 | 28 | | 15.09 | 17.91 | 34 | 38 | 41 | | |
| 1CO-36-16 | M36X2 | 1.5/16"X12 | 28 | | 15 | 14.5 | 34 | 41 | 41 | | |
| 1CO-45-16 | M45X2 | 1.5/16"X12 | 35 | | 15 | 22.5 | 39 | 46 | 50 | | |
| 1CO-45-20 | M45X2 | 1.5/8"X12 | 35 | | 15.09 | 16.41 | 39 | 50 | 50 | | |
| 1CO-52-20 | M52X2 | 1.5/8"X12 | 42 | | 15.09 | 19.91 | 42 | 55 | 60 | | |
| 1DO-16-04 | M16X1.5 | 7/16"X20 | 8 | | 9 | 13 | 30 | 17 | 19 | | |
| 1DO-18-06 | M18X1.5 | 9/16"X18 | 10 | | 10 | 12.5 | 31 | 19 | 22 | | |
| 1DO-20-06 | M20X1.5 | 9/16"X18 | 12 | | 10 | 16.5 | 31 | 22 | 24 | | |
| 1DO-20-08 | M20X1.5 | 3/4"X16 | 12 | | 11 | 18 | 34 | 24 | 24 | | |
| 1DO-24-08 | M24X1.5 | 3/4"X16 | 16 | | 11 | 18.5 | 34 | 24 | 30 | | 40 重系列 S |
| 1DO-24-10 | M24X1.5 | 7/8"X14 | 16 | | 12.7 | 18.8 | 37 | 27 | 30 | | |
| 1DO-30-08 | M30X2 | 3/4"X16 | 20 | | 11 | 21 | 42 | 32 | 36 | | |
| 1DO-30-10 | M30X2 | 7/8"X14 | 20 | | 12.7 | 19.8 | 42 | 32 | 36 | | |
| 1DO-30-12 | M30X2 | 1.1/16"X12 | 20 | | 15 | 17.5 | 42 | 32 | 36 | | |
| 1DO-36-12 | M36X2 | 1.1/16"X12 | 25 | | 15.09 | 21.91 | 47 | 41 | 46 | | |
| 1DO-36-16 | M36X2 | 1.5/16"X12 | 25 | | 15 | 20 | 47 | 41 | 46 | | |
| 1DO-42-16 | M42X2 | 1.5/16"X12 | 30 | | 15 | 22.5 | 50 | 46 | 50 | | |
| 1DO-42-20 | M42X2 | 1.5/8"X12 | 30 | | 15 | 20.5 | 50 | 50 | 50 | | |
| 1DO-52-20 | M52X2 | 1.5/8"X12 | 38 | | 15.09 | 25.91 | 53.9 | 55 | 60 | | |

注：如需带卡套及卡套螺母整套订货，则请在代号后加“RN”，如1DO-30-12RN。

Note: In case if you are interested to order the adapter in complete set with cutting ring and nut ,it is necessary to insert suffix "RN" after our part no., for example 1DO-30-12RN.

DIN卡套接头 DIN Bite Type Tube Fittings

B

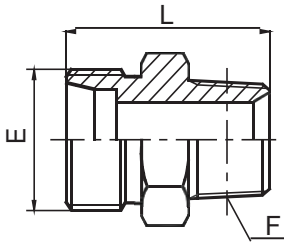

1CT-SP
1DT-SP

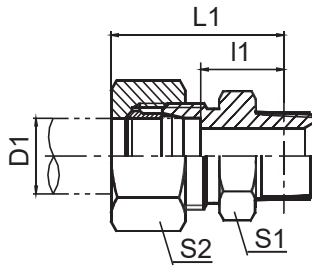

1CT-SPRN
1DT-SPRN

英锥管外螺纹
BSPT MALE

| 代号 PART NO. | 螺 纹 THREAD | | 管子外径 TUBE O.D. D | 尺 寸 DIMENSIONS | | | | 压力等级 MPa |
|----------------|------------|------------|---------------------|----------------|------|----|----|----------------|
| | E | F | | l1 | L1 | S1 | S2 | |
| 1CT-12-02SP | M12x1.5 | R1/8"x28 | 6 | 13 | 28 | 12 | 14 | 25 轻系列 L |
| 1CT-12-04SP | M12x1.5 | R1/4"x19 | 8 | 16.5 | 31.5 | 14 | 14 | |
| 1CT-14-04SP | M14x1.5 | R1/4"x19 | 8 | 16.5 | 31.5 | 14 | 17 | |
| 1CT-14-06SP | M14x1.5 | R3/8"x19 | 8 | 17.6 | 32.6 | 17 | 17 | |
| 1CT-16-04SP | M16x1.5 | R1/4"x19 | 10 | 17.5 | 32.5 | 17 | 19 | |
| 1CT-16-06SP | M16x1.5 | R3/8"x19 | 10 | 17.6 | 33.6 | 17 | 19 | |
| 1CT-16-08SP | M16x1.5 | R1/2"x14 | 10 | 21.8 | 36.8 | 22 | 19 | |
| 1CT-16-12SP | M16x1.5 | R3/4"x14 | 10 | 24.5 | 36.5 | 30 | 19 | |
| 1CT-18-04SP | M18x1.5 | R1/4"x19 | 12 | 18.5 | 33.5 | 19 | 22 | |
| 1CT-18-06SP | M18x1.5 | R3/8"x19 | 12 | 18.6 | 33.6 | 19 | 22 | |
| 1CT-18-08SP | M18x1.5 | R1/2"x14 | 12 | 21.8 | 36.8 | 22 | 22 | |
| 1CT-22-08SP | M22x1.5 | R1/2"x14 | 15 | 22.8 | 37.8 | 24 | 27 | |
| 1CT-26-08SP | M26x1.5 | R1/2"x14 | 18 | 23.3 | 39.8 | 27 | 32 | |
| 1CT-26-12SP | M26x1.5 | R3/4"x14 | 18 | 22 | 38.5 | 30 | 32 | |
| 1CT-30-12SP | M30x2 | R3/4"x14 | 22 | 24 | 40.5 | 32 | 36 | |
| 1CT-36-16SP | M36x2 | R1"x11 | 28 | 29.6 | 46.1 | 38 | 41 | |
| 1CT-36-20SP | M36x2 | R1.1/4"x11 | 28 | 29.3 | 45.8 | 46 | 41 | |
| 1CT-45-16SP | M45x2 | R1"x11 | 35 | 29.6 | 51.1 | 46 | 50 | |
| 1CT-45-20SP | M45x2 | R1.1/4"x11 | 35 | 28.3 | 49.8 | 46 | 50 | |
| 1CT-52-20SP | M52x2 | R1.1/4"x11 | 42 | 29.8 | 52.8 | 55 | 60 | |
| 1CT-52-24SP | M52x2 | R1.1/2"x11 | 42 | 29.8 | 52.8 | 55 | 60 | |
| 1DT-14-04SP | M14x1.5 | R1/4"x19 | 6 | 13 | 36.5 | 17 | 17 | |
| 1DT-16-04SP | M16x1.5 | R1/4"x19 | 8 | 21.5 | 36.5 | 17 | 19 | |
| 1DT-18-04SP | M18x1.5 | R1/4"x19 | 10 | 21 | 37.5 | 19 | 22 | |
| 1DT-20-04SP | M20x1.5 | R1/4"x19 | 12 | 23 | 39.5 | 22 | 24 | |
| 1DT-20-06SP | M20x1.5 | R3/8"x19 | 12 | 23.1 | 39.6 | 22 | 24 | |
| 1DT-22-06SP | M22x1.5 | R3/8"x19 | 14 | 24.6 | 42.6 | 24 | 27 | |
| 1DT-22-08SP | M22x1.5 | R1/2"x14 | 14 | 27.8 | 45.8 | 24 | 27 | |
| 1DT-24-06SP | M24x1.5 | R3/8"x19 | 16 | 24.1 | 42.6 | 27 | 30 | |
| 1DT-24-08SP | M24x1.5 | R1/2"x14 | 16 | 27.3 | 45.8 | 27 | 30 | |
| 1DT-30-12SP | M30x2 | R3/4"x14 | 20 | 28 | 49.5 | 32 | 36 | |
| 1DT-36-12SP | M36x2 | R3/4"x14 | 25 | 29.5 | 53.5 | 41 | 46 | |
| 1DT-36-16SP | M36x2 | R1"x11 | 25 | 34.1 | 58.1 | 41 | 46 | |
| 1DT-42-16SP | M42x2 | R1"x11 | 30 | 35.6 | 62.1 | 46 | 50 | |
| 1DT-42-20SP | M42x2 | R1.1/4"x11 | 30 | 34.3 | 60.8 | 46 | 50 | |
| 1DT-52-20SP | M52x2 | R1.1/4"x11 | 38 | 36.8 | 67.8 | 55 | 60 | |
| 1DT-52-24SP | M52x2 | R1.1/2"x11 | 38 | 36.8 | 67.8 | 55 | 60 | |

注：如需带卡套及卡套螺母整套订货，则请在代号后加“RN”，如1DT-22-08SPRN。

Note: In case if you are interested to order the adapter in complete set with cutting ring and nut, it is necessary to insert suffix "RN" after our part no., for example 1DT-22-08SPRN.

DIN卡套接头 DIN Bite Type Tube Fittings

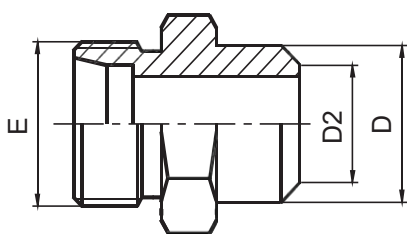

1CW
1DW

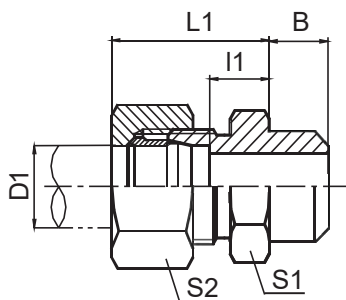

1CW-RN
1DW-RN

焊接接头
WELD FITTINGS

| 代号 PART NO. | 螺 纹 | THREAD | 管子外径 TUBE O.D. | | 尺 寸 DIMENSIONS | | | | | | 压力等级 MPa |
|----------------|---------|--------|----------------|----|----------------|----|------|----|----|----|------------------|
| | E | | D1 | D2 | B | D | I1 | L1 | S1 | S2 | |
| 1CW-12-06 | M12x1.5 | | 6 | 6 | 7 | 10 | 7 | 22 | 12 | 14 | 31.5 轻系列 L |
| 1CW-14-08 | M14x1.5 | | 8 | 8 | 8 | 12 | 8 | 23 | 14 | 17 | |
| 1CW-16-10 | M16x1.5 | | 10 | 10 | 8 | 14 | 10 | 24 | 17 | 19 | |
| 1CW-18-12 | M18x1.5 | | 12 | 12 | 8 | 16 | 10 | 25 | 19 | 22 | |
| 1CW-22-15 | M22x1.5 | | 15 | 15 | 10 | 19 | 11 | 26 | 22 | 27 | |
| 1CW-26-18 | M26X1.5 | | 18 | 18 | 10 | 22 | 13.5 | 28 | 27 | 32 | |
| 1CW-26-22 | M26X1.5 | | 18 | 22 | 10 | 27 | 12.5 | 28 | 27 | 32 | 16 轻系列 L |
| 1CW-30-22 | M30x2 | | 22 | 22 | 12 | 27 | 16.5 | 30 | 32 | 36 | |
| 1CW-30-25 | M30x2 | | 22 | 25 | 12 | 31 | 13.5 | 30 | 32 | 36 | |
| 1CW-36-28 | M36x2 | | 28 | 28 | 12 | 32 | 18.5 | 33 | 41 | 41 | |
| 1CW-45-35 | M45X2 | | 35 | 35 | 14 | 40 | 18.5 | 36 | 46 | 50 | |
| 1CW-52-42 | M52X2 | | 42 | 42 | 16 | 46 | 19 | 39 | 55 | 60 | |
| 1DW-14-06 | M14x1.5 | | 6 | 6 | 7 | 11 | 11 | 26 | 14 | 17 | 63 重系列 S |
| 1DW-16-08 | M16x1.5 | | 8 | 8 | 8 | 13 | 13 | 28 | 17 | 19 | |
| 1DW-18-10 | M18x1.5 | | 10 | 10 | 8 | 15 | 12.5 | 29 | 19 | 22 | |
| 1DW-20-12 | M20x1.5 | | 12 | 12 | 10 | 17 | 14.5 | 31 | 22 | 24 | |
| 1DW-22-14 | M22x1.5 | | 14 | 14 | 10 | 19 | 16 | 34 | 24 | 27 | |
| 1DW-24-16 | M24x1.5 | | 16 | 16 | 10 | 21 | 15.5 | 34 | 27 | 30 | 40 重系列 S |
| 1DW-30-20 | M30x2 | | 20 | 20 | 12 | 26 | 17.5 | 39 | 32 | 36 | |
| 1DW-36-25 | M36x2 | | 25 | 25 | 12 | 31 | 20 | 44 | 41 | 46 | |
| 1DW-42-30 | M42x2 | | 30 | 30 | 14 | 36 | 20.5 | 47 | 46 | 50 | |
| 1DW-52-38 | M52X2 | | 38 | 38 | 16 | 44 | 23 | 54 | 55 | 60 | 31.5重系列S |

注：如需带卡套及卡套螺母整套订货，则请在代号后加“RN”，如1DW-20-12RN。

Note: In case if you are interested to order the adapter in complete set with cutting ring and nut ,it is necessary to insert suffix "RN" after our part no., for example 1DW-20-12RN.

DIN卡套接头 DIN Bite Type Tube Fittings

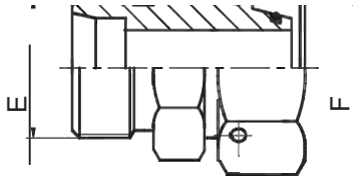

2C

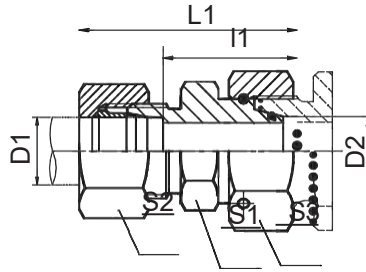

2C-RN

外螺纹内螺纹转换接头
REDUCER TUBE ADAPTOR
WITH SWIVEL NUT

| 代号 PART NO. | 螺 纹 THREAD | | 管子外径 TUBE O.D. | | 尺 寸 DIMENSIONS | | | | | | 压力等级 MPa |
|----------------|------------|---------|----------------|----|----------------|----|----|----|----|--|------------------|
| | E | F | D1 | D2 | l1 | L1 | S1 | S2 | S3 | | |
| 2C-12-14 | M12X1.5 | M14X1.5 | 6 | 8 | 23.5 | 38 | 12 | 14 | 17 | | 31.5 轻系列 L |
| 2C-12-16 | M12X1.5 | M16X1.5 | 6 | 10 | 25 | 40 | 14 | 14 | 19 | | |
| 2C-14-16 | M14X1.5 | M16X1.5 | 8 | 10 | 25 | 40 | 14 | 17 | 19 | | |
| 2C-12-18 | M12X1.5 | M18X1.5 | 6 | 12 | 25 | 40 | 17 | 14 | 22 | | |
| 2C-14-18 | M14X1.5 | M18X1.5 | 8 | 12 | 25 | 40 | 17 | 17 | 22 | | |
| 2C-16-18 | M16X1.5 | M18X1.5 | 10 | 12 | 26 | 41 | 17 | 19 | 22 | | |
| 2C-12-22 | M12X1.5 | M22X1.5 | 6 | 15 | 28.5 | 43 | 19 | 14 | 27 | | |
| 2C-14-22 | M14X1.5 | M22X1.5 | 8 | 15 | 28.5 | 43 | 19 | 17 | 27 | | |
| 2C-16-22 | M16X1.5 | M22X1.5 | 10 | 15 | 29.5 | 44 | 19 | 19 | 27 | | |
| 2C-18-22 | M18X1.5 | M22X1.5 | 12 | 15 | 29.5 | 44 | 19 | 22 | 27 | | |
| 2C-12-26 | M12X1.5 | M26X1.5 | 6 | 18 | 28 | 43 | 24 | 14 | 32 | | |
| 2C-22-26 | M22X1.5 | M26X1.5 | 15 | 18 | 30 | 45 | 24 | 27 | 32 | | |
| 2C-12-30 | M12X1.5 | M30X2 | 6 | 22 | 32 | 47 | 27 | 14 | 36 | | |
| 2C-14-30 | M14X1.5 | M30X2 | 8 | 22 | 32 | 47 | 27 | 17 | 36 | | |
| 2C-16-30 | M16X1.5 | M30X2 | 10 | 22 | 33 | 48 | 27 | 19 | 36 | | |
| 2C-18-30 | M18X1.5 | M30X2 | 12 | 22 | 33 | 48 | 27 | 22 | 36 | | |
| 2C-22-30 | M22X1.5 | M30X2 | 15 | 22 | 34 | 49 | 27 | 27 | 36 | | |
| 2C-26-30 | M26X1.5 | M30X2 | 18 | 22 | 33.5 | 50 | 27 | 32 | 36 | | |
| 2C-12-36 | M12X1.5 | M36X2 | 6 | 28 | 34 | 49 | 36 | 14 | 41 | | |
| 2C-14-36 | M14X1.5 | M36X2 | 8 | 28 | 34 | 49 | 36 | 17 | 41 | | |
| 2C-16-36 | M16X1.5 | M36X2 | 10 | 28 | 35 | 50 | 36 | 19 | 41 | | |
| 2C-18-36 | M18X1.5 | M36X2 | 12 | 28 | 35 | 50 | 36 | 22 | 41 | | |
| 2C-22-36 | M22X1.5 | M36X2 | 15 | 28 | 36 | 51 | 36 | 27 | 41 | | |
| 2C-26-36 | M26X1.5 | M36X2 | 18 | 28 | 35.5 | 52 | 36 | 32 | 41 | | |
| 2C-30-36 | M30X2 | M36X2 | 22 | 28 | 37.5 | 54 | 36 | 36 | 41 | | |
| 2C-12-45 | M12X1.5 | M45X2 | 6 | 35 | 37 | 52 | 41 | 14 | 50 | | |
| 2C-14-45 | M14X1.5 | M45X2 | 8 | 35 | 37 | 52 | 41 | 17 | 50 | | |
| 2C-16-45 | M16X1.5 | M45X2 | 10 | 35 | 38 | 53 | 41 | 19 | 50 | | |
| 2C-18-45 | M18X1.5 | M45X2 | 12 | 35 | 38 | 53 | 41 | 22 | 50 | | |
| 2C-22-45 | M22X1.5 | M45X2 | 15 | 35 | 39 | 54 | 41 | 27 | 50 | | |
| 2C-26-45 | M26X1.5 | M45X2 | 18 | 35 | 38.5 | 55 | 41 | 32 | 50 | | |
| 2C-30-45 | M30X2 | M45X2 | 22 | 35 | 40.5 | 57 | 41 | 36 | 50 | | |
| 2C-36-45 | M36X2 | M45X2 | 28 | 35 | 40.5 | 57 | 41 | 41 | 50 | | |
| 2C-12-52 | M12X1.5 | M52X2 | 6 | 42 | 40.5 | 55 | 50 | 14 | 60 | | |
| 2C-14-52 | M14X1.5 | M52X2 | 8 | 42 | 40.5 | 55 | 50 | 17 | 60 | | |
| 2C-16-52 | M16X1.5 | M52X2 | 10 | 42 | 41.5 | 56 | 50 | 19 | 60 | | |
| 2C-18-52 | M18X1.5 | M52X2 | 12 | 42 | 41.5 | 56 | 50 | 22 | 60 | | |
| 2C-22-52 | M22X1.5 | M52X2 | 15 | 42 | 42.5 | 58 | 50 | 27 | 60 | | |
| 2C-26-52 | M26X1.5 | M52X2 | 18 | 42 | 42 | 58 | 50 | 32 | 60 | | |
| 2C-30-52 | M30X2 | M52X2 | 22 | 42 | 44 | 60 | 50 | 36 | 60 | | |
| 2C-36-52 | M36X2 | M52X2 | 28 | 42 | 44 | 61 | 50 | 41 | 60 | | |
| 2C-45-52 | M45X2 | M52X2 | 35 | 42 | 43 | 65 | 50 | 50 | 60 | | |

注：如需带卡套及卡套螺母整套订货，则请在代号后加“RN”，如2C-30-52RN。

Note: In case if you are interested to order the adapter in complete set with cutting ring and nut ,it is necessary to insert suffix "RN" after our part no. , for example 2C-30-52RN.

DIN卡套接头 DIN Bite Type Tube Fittings

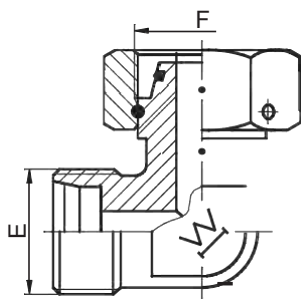

2C9
2D9

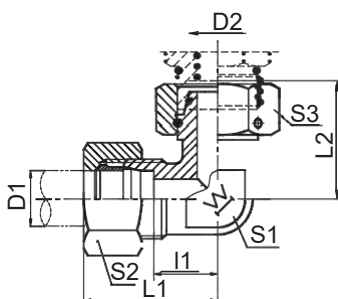

2C9-RN
2D9-RN

外螺纹内螺纹转换接头90°弯
REDUCER TUBE ADAPTOR
WITH SWIVEL NUT 90° ELBOW

| 代号 PART NO. | 螺 纹 THREAD | | 管子外径 TUBE O.D. | | 尺 寸 DIMENSIONS | | | | | | 压力等级 MPa |
|----------------|------------|---------|----------------|----|----------------|----|------|----|----|----|----------------|
| | E | F | D1 | D2 | l1 | L1 | L2 | S1 | S2 | S3 | |
| 2C9-12 | M12X1.5 | M12X1.5 | 6 | 6 | 12 | 27 | 26 | 12 | 14 | 14 | 25 轻系列 L |
| 2C9-14 | M14X1.5 | M14X1.5 | 8 | 8 | 14 | 29 | 27.5 | 12 | 17 | 17 | |
| 2C9-16 | M16X1.5 | M16X1.5 | 10 | 10 | 15 | 30 | 29 | 14 | 19 | 19 | |
| 2C9-18 | M18X1.5 | M18X1.5 | 12 | 12 | 17 | 32 | 29.5 | 17 | 22 | 22 | |
| 2C9-22 | M22X1.5 | M22X1.5 | 15 | 15 | 21 | 36 | 32.5 | 19 | 27 | 27 | |
| 2C9-26 | M26X1.5 | M26X1.5 | 18 | 18 | 23.5 | 40 | 35.5 | 24 | 32 | 32 | |
| 2C9-30 | M30X2 | M30X2 | 22 | 22 | 27.5 | 44 | 38.5 | 27 | 36 | 36 | 16 轻系列L |
| 2C9-36 | M36X2 | M36X2 | 28 | 28 | 30.5 | 47 | 41.5 | 36 | 41 | 41 | |
| 2C9-45 | M45X2 | M45X2 | 35 | 35 | 34.5 | 56 | 51 | 41 | 50 | 50 | |
| 2C9-52 | M52X2 | M52X2 | 42 | 42 | 40 | 63 | 56 | 50 | 60 | 60 | |
| 2D9-14 | M14X1.5 | M14X1.5 | 6 | 6 | 16 | 31 | 27 | 12 | 17 | 17 | 63 重系列 S |
| 2D9-16 | M16X1.5 | M16X1.5 | 8 | 8 | 17 | 32 | 27.5 | 14 | 19 | 19 | |
| 2D9-18 | M18X1.5 | M18X1.5 | 10 | 10 | 17.5 | 34 | 30 | 17 | 22 | 22 | |
| 2D9-20 | M20X1.5 | M20X1.5 | 12 | 12 | 21.5 | 38 | 31 | 17 | 24 | 24 | |
| 2D9-22 | M22X1.5 | M22X1.5 | 14 | 14 | 22 | 40 | 35 | 19 | 27 | 27 | |
| 2D9-24 | M24X1.5 | M24X1.5 | 16 | 16 | 24.5 | 43 | 36.5 | 24 | 30 | 30 | 40 重系列 S |
| 2D9-30 | M30X2 | M30X2 | 20 | 20 | 26.5 | 48 | 44.5 | 27 | 36 | 36 | |
| 2D9-36 | M36X2 | M36X2 | 25 | 25 | 30 | 54 | 50 | 36 | 46 | 46 | |
| 2D9-42 | M42X2 | M42X2 | 30 | 30 | 35.5 | 62 | 55 | 41 | 50 | 50 | |
| 2D9-52 | M52X2 | M52X2 | 38 | 38 | 41 | 72 | 63 | 50 | 60 | 60 | |

注：如需带卡套及卡套螺母整套订货，则请在代号后加“RN”，如2C9-30RN。

Note: In case if you are interested to order the adapter in complete set with cutting ring and nut ,it is necessary to insert suffix "RN" after our part no. , for example 2C9-30RN.

DIN卡套接头 DIN Bite Type Tube Fittings

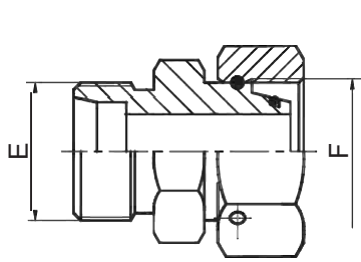

2D

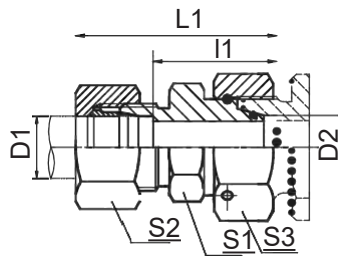

2D-RN

外螺纹内螺纹转换接头
REDUCER TUBE ADAPTOR
WITH SWIVEL NUT

| 代号 PART NO. | 螺 纹 THREAD | | 管子外径 TUBE O.D. | | 尺 寸 DIMENSIONS | | | | | | 压力等级 MPa | |
|----------------|------------|---------|----------------|----|----------------|----|----|----|----|--|------------------|------------------|
| | E | F | D1 | D2 | l1 | L1 | S1 | S2 | S3 | | | |
| 2D-14-16 | M14X1.5 | M16X1.5 | 6 | 8 | 27 | 42 | 14 | 17 | 19 | | 63 重系列 S | |
| 2D-14-18 | M14X1.5 | M18X1.5 | 6 | 10 | 27.5 | 42 | 17 | 17 | 22 | | | |
| 2D-16-18 | M16X1.5 | M18X1.5 | 8 | 10 | 27.5 | 42 | 17 | 19 | 22 | | | |
| 2D-14-20 | M14X1.5 | M20X1.5 | 6 | 12 | 29 | 44 | 17 | 17 | 24 | | | |
| 2D-16-20 | M16X1.5 | M20X1.5 | 8 | 12 | 29 | 44 | 17 | 19 | 24 | | | |
| 2D-18-20 | M18X1.5 | M20X1.5 | 10 | 12 | 31 | 46 | 19 | 22 | 24 | | | |
| 2D-14-22 | M14X1.5 | M22X1.5 | 6 | 14 | 31.5 | 46 | 19 | 17 | 27 | | | |
| 2D-16-22 | M16X1.5 | M22X1.5 | 8 | 14 | 31.5 | 46 | 19 | 19 | 27 | | | |
| 2D-18-22 | M18X1.5 | M22X1.5 | 10 | 14 | 31 | 47 | 19 | 22 | 27 | | | |
| 2D-20-22 | M20X1.5 | M22X1.5 | 12 | 14 | 31 | 47 | 22 | 24 | 27 | | | |
| 2D-14-24 | M14X1.5 | M24X1.5 | 6 | 16 | 32 | 47 | 22 | 17 | 30 | | 40 重系列 S | |
| 2D-16-24 | M16X1.5 | M24X1.5 | 8 | 16 | 32 | 47 | 22 | 19 | 30 | | | |
| 2D-18-24 | M18X1.5 | M24X1.5 | 10 | 16 | 31.5 | 48 | 22 | 22 | 30 | | | |
| 2D-20-24 | M20X1.5 | M24X1.5 | 12 | 16 | 33.5 | 50 | 22 | 24 | 30 | | | |
| 2D-22-24 | M22X1.5 | M24X1.5 | 14 | 16 | 33 | 51 | 24 | 27 | 30 | | | |
| 2D-14-30 | M14X1.5 | M30X2 | 6 | 20 | 36 | 51 | 27 | 17 | 36 | | | |
| 2D-16-30 | M16X1.5 | M30X2 | 8 | 20 | 36 | 51 | 27 | 19 | 36 | | | |
| 2D-18-30 | M18X1.5 | M30X2 | 10 | 20 | 35.5 | 52 | 27 | 22 | 36 | | | |
| 2D-20-30 | M20X1.5 | M30X2 | 12 | 20 | 35.5 | 52 | 27 | 24 | 36 | | | |
| 2D-22-30 | M22X1.5 | M30X2 | 14 | 20 | 37 | 55 | 27 | 27 | 36 | | | |
| 2D-24-30 | M24X1.5 | M30X2 | 16 | 20 | 37.5 | 55 | 30 | 30 | 36 | | | |
| 2D-14-36 | M14X1.5 | M36X2 | 6 | 25 | 38.5 | 53 | 36 | 17 | 46 | | | 31.5 重系列 S |
| 2D-16-36 | M16X1.5 | M36X2 | 8 | 25 | 38.5 | 53 | 36 | 19 | 46 | | | |
| 2D-18-36 | M18X1.5 | M36X2 | 10 | 25 | 38 | 54 | 36 | 22 | 46 | | | |
| 2D-20-36 | M20X1.5 | M36X2 | 12 | 25 | 38 | 54 | 36 | 24 | 46 | | | |
| 2D-22-36 | M22X1.5 | M36X2 | 14 | 25 | 39.5 | 57 | 36 | 27 | 46 | | | |
| 2D-24-36 | M24X1.5 | M36X2 | 16 | 25 | 39 | 57 | 36 | 30 | 46 | | | |
| 2D-30-36 | M30X2 | M36X2 | 20 | 25 | 39 | 61 | 36 | 36 | 46 | | | |
| 2D-14-42 | M14X1.5 | M42X2 | 6 | 30 | 44 | 59 | 41 | 17 | 50 | | | |
| 2D-16-42 | M16X1.5 | M42X2 | 8 | 30 | 44 | 59 | 41 | 19 | 50 | | | |
| 2D-18-42 | M18X1.5 | M42X2 | 10 | 30 | 43.5 | 60 | 41 | 22 | 50 | | | |
| 2D-20-42 | M20X1.5 | M42X2 | 12 | 30 | 43.5 | 60 | 41 | 24 | 50 | | | |
| 2D-22-42 | M22X1.5 | M42X2 | 14 | 30 | 45 | 63 | 41 | 27 | 50 | | | |
| 2D-24-42 | M24X1.5 | M42X2 | 16 | 30 | 44.5 | 63 | 41 | 30 | 50 | | | |
| 2D-30-42 | M30X2 | M42X2 | 20 | 30 | 44.5 | 66 | 41 | 36 | 50 | | | |
| 2D-36-42 | M36X2 | M42X2 | 25 | 30 | 44 | 69 | 41 | 46 | 50 | | | |
| 2D-14-52 | M14X1.5 | M52X2 | 6 | 38 | 47.5 | 62 | 50 | 17 | 60 | | 31.5 重系列 S | |
| 2D-16-52 | M16X1.5 | M52X2 | 8 | 38 | 47.5 | 62 | 50 | 19 | 60 | | | |
| 2D-18-52 | M18X1.5 | M52X2 | 10 | 38 | 47 | 63 | 50 | 22 | 60 | | | |
| 2D-20-52 | M20X1.5 | M52X2 | 12 | 38 | 47 | 63 | 50 | 24 | 60 | | | |
| 2D-22-52 | M22X1.5 | M52X2 | 14 | 38 | 48.5 | 66 | 50 | 27 | 60 | | | |
| 2D-24-52 | M24X1.5 | M52X2 | 16 | 38 | 48 | 66 | 50 | 30 | 60 | | | |
| 2D-30-52 | M30X2 | M52X2 | 20 | 38 | 48 | 70 | 50 | 36 | 60 | | | |
| 2D-36-52 | M36X2 | M52X2 | 25 | 38 | 48.5 | 73 | 50 | 46 | 60 | | | |
| 2D-42-52 | M42X2 | M52X2 | 30 | 38 | 49 | 76 | 50 | 50 | 60 | | | |

注：如需带卡套及卡套螺母整套订货，则请在代号后加“RN”，如2D-30-52RN。

Note: In case if you are interested to order the adaptor in complete set with cutting ring and nut ,it is necessary to insert suffix "RN" after our part no. , for example 2D-30-52RN.

DIN卡套接头 DIN Bite Type Tube Fittings

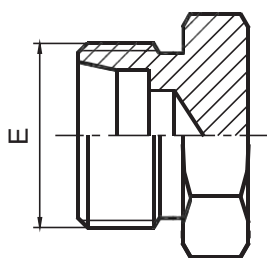

4C
4D

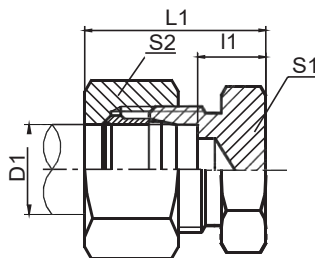

4C-RN
4D-RN

堵头
PLUG

| 代号 PART NO. | 螺 纹 THREAD | 管子外径 TUBE O.D. | 尺 寸 DIMENSIONS | | | | | | 压力等级 MPa |
|----------------|------------|----------------|----------------|----|----|----|--|--|------------------|
| | E | D1 | I1 | L1 | S1 | S2 | | | |
| 4C-12 | M12x1.5 | 6 | 7 | 22 | 12 | 14 | | | 31.5 轻系列 L |
| 4C-14 | M14x1.5 | 8 | 8 | 23 | 14 | 17 | | | |
| 4C-16 | M16x1.5 | 10 | 9 | 24 | 17 | 19 | | | |
| 4C-18 | M18x1.5 | 12 | 10 | 25 | 19 | 22 | | | |
| 4C-22 | M22x1.5 | 15 | 11 | 26 | 24 | 27 | | | |
| 4C-26 | M26X1.5 | 18 | 11.5 | 28 | 27 | 32 | | | |
| 4C-30 | M30x2 | 22 | 13.5 | 30 | 32 | 36 | | | 16 轻系列 L |
| 4C-30D | M30x1.5 | 22 | 13.5 | 30 | 32 | 36 | | | |
| 4C-36 | M36x2 | 28 | 14.5 | 31 | 41 | 41 | | | |
| 4C-36D | M36x1.5 | 28 | 14.5 | 31 | 41 | 41 | | | |
| 4C-45 | M45X2 | 35 | 14.5 | 36 | 46 | 50 | | | |
| 4C-45D | M45X1.5 | 35 | 14.5 | 36 | 46 | 50 | | | |
| 4C-52 | M52X2 | 42 | 16 | 39 | 55 | 60 | | | 63 重系列 S |
| 4D-14 | M14X1.5 | 6 | 11 | 26 | 14 | 17 | | | |
| 4D-16 | M16X1.5 | 8 | 13 | 28 | 17 | 19 | | | |
| 4D-18 | M18x1.5 | 10 | 12.5 | 29 | 19 | 22 | | | |
| 4D-20 | M20x1.5 | 12 | 14.5 | 31 | 22 | 24 | | | |
| 4D-22 | M22x1.5 | 14 | 16 | 34 | 24 | 27 | | | 40 重系列 S |
| 4D-24 | M24x1.5 | 16 | 15.5 | 34 | 27 | 30 | | | |
| 4D-30 | M30x2 | 20 | 17.5 | 39 | 32 | 36 | | | |
| 4D-36 | M36x2 | 25 | 20 | 44 | 38 | 46 | | | |
| 4D-42 | M42x2 | 30 | 20.5 | 47 | 46 | 50 | | | 31.5重系列S |
| 4D-52 | M52X2 | 38 | 23 | 54 | 55 | 60 | | | |

注：如需带卡套及卡套螺母整套订货，则请在代号后加“RN”，如4C-30RN。

Note: In case if you are interested to order the adapter in complete set with cutting ring and nut ,it is necessary to insert suffix "RN" after our part no., for example 4C-30RN.

DIN卡套接头 DIN Bite Type Tube Fittings

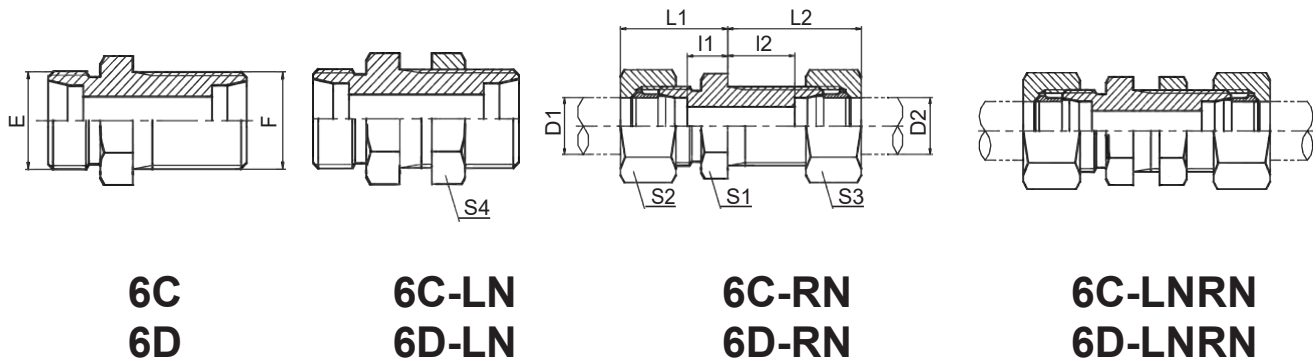

直通过板接头
STRAIGHT BULKHEAD FITTINGS

| 代号 PART NO. | 螺 纹 THREAD | | 管子外径 TUBE O.D. | | 尺 寸 DIMENSIONS | | | | | | | 压力等级 MPa |
|----------------|------------|---------|----------------|----|----------------|------|----|----|----|-------|----|------------------|
| | E | F | D1 | D2 | l1 | l2 | L1 | L2 | S1 | S2,S3 | S4 | |
| 6C-12 | M12X1.5 | M12X1.5 | 6 | 6 | 7 | 27 | 22 | 42 | 17 | 14 | 17 | 31.5 轻系列 L |
| 6C-14 | M14X1.5 | M14X1.5 | 8 | 8 | 8 | 27 | 23 | 42 | 19 | 17 | 19 | |
| 6C-16 | M16X1.5 | M16X1.5 | 10 | 10 | 10 | 28 | 25 | 43 | 22 | 19 | 22 | |
| 6C-18 | M18X1.5 | M18X1.5 | 12 | 12 | 10 | 29 | 25 | 44 | 24 | 22 | 24 | |
| 6C-22 | M22X1.5 | M22X1.5 | 15 | 15 | 12 | 31 | 27 | 46 | 27 | 27 | 30 | |
| 6C-26 | M26X1.5 | M26X1.5 | 18 | 18 | 13.5 | 33 | 30 | 49 | 32 | 32 | 36 | |
| 6C-30 | M30X2 | M30X2 | 22 | 22 | 16.5 | 35 | 33 | 51 | 36 | 36 | 41 | 16 轻系列L |
| 6C-36 | M36X2 | M36X2 | 28 | 28 | 18.5 | 35.5 | 35 | 52 | 41 | 41 | 46 | |
| 6C-45 | M45X2 | M45X2 | 35 | 35 | 18.5 | 36.5 | 40 | 58 | 50 | 50 | 55 | |
| 6C-52 | M52X2 | M52X2 | 42 | 42 | 19 | 36 | 42 | 59 | 60 | 60 | 65 | |
| 6D-14 | M14X1.5 | M14X1.5 | 6 | 6 | 12 | 29 | 27 | 44 | 19 | 17 | 19 | 63 重系列 S |
| 6D-16 | M16X1.5 | M16X1.5 | 8 | 8 | 13 | 29 | 28 | 44 | 22 | 19 | 22 | |
| 6D-18 | M18X1.5 | M18X1.5 | 10 | 10 | 14.5 | 29.5 | 31 | 46 | 24 | 22 | 24 | |
| 6D-20 | M20X1.5 | M20X1.5 | 12 | 12 | 14.5 | 30.5 | 31 | 47 | 27 | 24 | 27 | |
| 6D-22 | M22X1.5 | M22X1.5 | 14 | 14 | 17 | 32 | 35 | 50 | 30 | 27 | 30 | |
| 6D-24 | M24X1.5 | M24X1.5 | 16 | 16 | 16.5 | 31.5 | 35 | 50 | 32 | 30 | 32 | 40 重系列 S |
| 6D-30 | M30X2 | M30X2 | 20 | 20 | 17.5 | 33.5 | 39 | 55 | 41 | 36 | 41 | |
| 6D-36 | M36X2 | M36X2 | 25 | 25 | 20 | 35 | 44 | 59 | 46 | 46 | 46 | |
| 6D-42 | M42X2 | M42X2 | 30 | 30 | 21.5 | 37.5 | 48 | 64 | 50 | 50 | 50 | |
| 6D-52 | M52X2 | M52X2 | 38 | 38 | 22 | 37 | 53 | 68 | 65 | 60 | 65 | 31.5重系列S |

注：如需带锁母订货，则请在代号后加“LN”，如6C-30LN；如需带卡套及卡套螺母订货，在代号后加“RN”，如6C-30RN；如需带锁母、卡套及卡套螺母订货，在代号后加“LNRN”，如6C-30LNRN。

Note: In case if you are interested to order the adapter with lock nut, please insert suffix "LN" after our part no., for example 6C-30LN, order the adapter with cutting ring and nut, insert suffix "RN" after part no., for example 6C-30RN, order the adapter with lock nut and cutting ring and nut, insert suffix "LNRN" after part no., for example 6C-30LNRN.

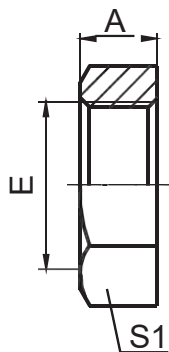

8C

公制螺纹锁母
METRIC LOCK NUT

| 代号 PART NO. | 螺 纹 THREAD | | | | 尺 寸 DIMENSIONS | | | | |
|----------------|------------|--|--|--|----------------|----|--|--|--|
| | E | | | | A | S1 | | | |
| 8C-10 | M10X1 | | | | 6 | 14 | | | |
| 8C-12 | M12x1.5 | | | | 7.5 | 17 | | | |
| 8C-14 | M14x1.5 | | | | 7.5 | 19 | | | |
| 8C-16 | M16x1.5 | | | | 7.5 | 22 | | | |
| 8C-18 | M18x1.5 | | | | 7.5 | 24 | | | |
| 8C-20 | M20x1.5 | | | | 8 | 27 | | | |
| 8C-22 | M22x1.5 | | | | 8 | 27 | | | |
| 8C-24 | M24x1.5 | | | | 8 | 30 | | | |
| 8C-26 | M26x1.5 | | | | 8 | 32 | | | |
| 8C-27D | M27x1.5 | | | | 8 | 32 | | | |
| 8C-27 | M27x2 | | | | 10 | 32 | | | |
| 8C-30 | M30x2 | | | | 10 | 36 | | | |
| 8C-33 | M33x2 | | | | 10 | 41 | | | |
| 8C-33D | M33X1.5 | | | | 10 | 41 | | | |
| 8C-36 | M36x2 | | | | 10 | 41 | | | |
| 8C-42 | M42x2 | | | | 10 | 50 | | | |
| 8C-45 | M45x2 | | | | 10 | 55 | | | |
| 8C-48 | M48x2 | | | | 10 | 55 | | | |
| 8C-52 | M52x2 | | | | 10 | 60 | | | |
| 8C-60 | M60x2 | | | | 10 | 65 | | | |

DIN卡套接头 DIN Bite Type Tube Fittings

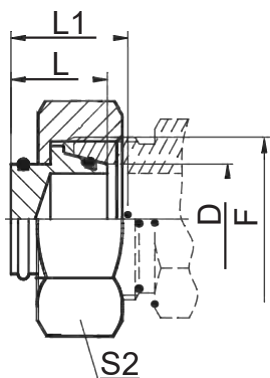

内螺纹堵头
FEMALE PLUG

9C
9D

| 代号 PART NO. | 螺 纹 THREAD | 管子外径 TUBE O.D. | 尺 寸 DIMENSIONS | | | | 压力等级 MPa |
|----------------|---------------|----------------|----------------|------|------|----|------------------|
| | | | F | D | L | L1 | |
| 9C-12 | M12X1.5 | 6 | | 15.5 | 17.5 | 14 | 31.5 轻系列 L |
| 9C-14 | M14X1.5 | 8 | | 15.5 | 18 | 17 | |
| 9C-16 | M16X1.5 | 10 | | 16.5 | 18 | 19 | |
| 9C-18 | M18X1.5 | 12 | | 18 | 19.5 | 22 | |
| 9C-22 | M22X1.5 | 15 | | 19.5 | 20 | 27 | |
| 9C-26 | M26X1.5 | 18 | | 20 | 22 | 32 | |
| 9C-30 | M30X2 | 22 | | 21.5 | 22.5 | 36 | 16 轻系列 L |
| 9C-36 | M36X2 | 28 | | 22.5 | 24.5 | 41 | |
| 9C-45 | M45X2 | 35 | | 25 | 29 | 50 | |
| 9C-52 | M52X2 | 42 | | 27 | 31.5 | 60 | |
| 9D-14 | M14X1.5 | 6 | | 16 | 18 | 17 | 63 重系列 S |
| 9D-16 | M16X1.5 | 8 | | 16.5 | 18.5 | 19 | |
| 9D-18 | M18X1.5 | 10 | | 18 | 20 | 22 | |
| 9D-20 | M20X1.5 | 12 | | 18.5 | 20.5 | 24 | |
| 9D-22 | M22X1.5 | 14 | | 19 | 21.5 | 27 | |
| 9D-24 | M24X1.5 | 16 | | 18.5 | 21.5 | 30 | 40 重系列 S |
| 9D-30 | M30X2 | 20 | | 22.5 | 25 | 36 | |
| 9D-36 | M36X2 | 25 | | 23.5 | 28.5 | 46 | |
| 9D-42 | M42X2 | 30 | | 25.5 | 32 | 50 | |
| 9D-52 | M52X2 | 38 | | 26.5 | 36 | 60 | 31.5重系列S |

DIN卡套接头 DIN Bite Type Tube Fittings

B

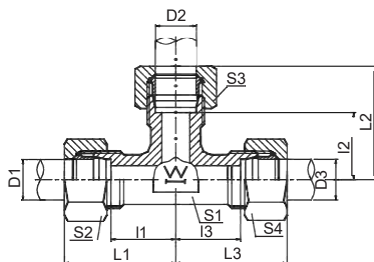
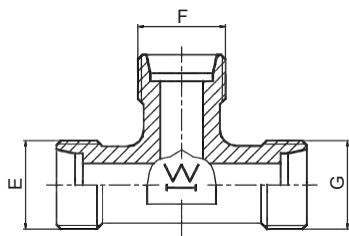

三通接头
EQUAL TEES

**AC
AD**

**AC-RN
AD-RN**

| 代号 PART NO. | 螺纹 THREAD | 管子外径 TUBE O.D. | 尺寸 DIMENSIONS | | | | | 压力等级 MPa |
|----------------|-----------|----------------|---------------|------------|----|------------|------------------|-------------|
| | E, F, G | D1, D2, D3 | I1, I2, I3 | L1, L2, L3 | S1 | S2, S3, S4 | | |
| AC-08 | M8X1 | 4 | 11 | 21 | 9 | 10 | 10 特轻系列 LL | |
| AC-10 | M10X1 | 5 | 9.5 | 21 | 9 | 12 | | |
| AC-10LL | M10X1 | 6 | 9.5 | 21 | 9 | 12 | | |
| AC-12LL | M12X1 | 8 | 11.5 | 23 | 12 | 14 | 25 轻系列 L | |
| AC-12 | M12X1.5 | 6 | 12 | 27 | 12 | 14 | | |
| AC-14 | M14X1.5 | 8 | 14 | 29 | 12 | 17 | | |
| AC-16 | M16X1.5 | 10 | 15 | 30 | 14 | 19 | | |
| AC-18 | M18X1.5 | 12 | 17 | 32 | 17 | 22 | | |
| AC-22 | M22X1.5 | 15 | 21 | 36 | 19 | 27 | | |
| AC-26 | M26X1.5 | 18 | 23.5 | 40 | 24 | 32 | 16 轻系列 L | |
| AC-30 | M30X2 | 22 | 27.5 | 44 | 27 | 36 | | |
| AC-36 | M36X2 | 28 | 30.5 | 47 | 36 | 41 | | |
| AC-45 | M45X2 | 35 | 34.5 | 56 | 41 | 50 | | |
| AC-52 | M52X2 | 42 | 40 | 63 | 50 | 60 | 63 重系列 S | |
| AD-14 | M14X1.5 | 6 | 16 | 31 | 12 | 17 | | |
| AD-16 | M16X1.5 | 8 | 17 | 32 | 14 | 19 | | |
| AD-18 | M18X1.5 | 10 | 17.5 | 34 | 17 | 22 | | |
| AD-20 | M20X1.5 | 12 | 21.5 | 38 | 17 | 24 | | |
| AD-22 | M22X1.5 | 14 | 22 | 40 | 19 | 27 | 40 重系列 S | |
| AD-24 | M24X1.5 | 16 | 24.5 | 43 | 24 | 30 | | |
| AD-30 | M30X2 | 20 | 26.5 | 48 | 27 | 36 | | |
| AD-36 | M36X2 | 25 | 30 | 54 | 36 | 46 | | |
| AD-42 | M42X2 | 30 | 35.5 | 62 | 41 | 50 | | |
| AD-52 | M52X2 | 38 | 41 | 72 | 50 | 60 | 31.5重系列S | |

注：如需带卡套及卡套螺母整套订货，则请在代号后加“RN”，如AC-22RN。

Note: In case if you are interested to order the adapter in complete set with cutting ring and nut, it is necessary to insert suffix "RN" after our part no., for example AC-22RN.

DIN卡套接头 DIN Bite Type Tube Fittings

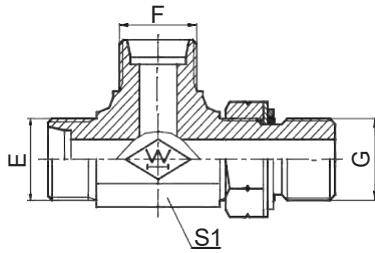

**ACCH-OG
ADDH-OG**

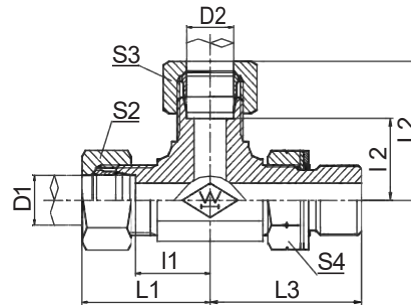

**ACCH-OG/RN
ADDH-OG/RN**

三通公制外螺纹24° 锥 / 公制
外螺纹可调向柱端ISO 6149-2

METRIC MALE 24° CONE / METRIC MALE
ADJUSTABLE STUD END ISO 6149-2
RUN TEE

| 代号 PART NO. | 螺纹 THREAD | | 管子外径 D1,D2 TUBE O.D. | O形圈 O-RING | 尺寸 DIMENSIONS | | | | | | 压力等级 MPa |
|-----------------|-----------|---------|----------------------------|---------------|---------------|-------|------|----|-------|----|------------------|
| | E,F | G | | | I1,I2 | L1,L2 | L3 | S1 | S2,S3 | S4 | |
| ACCH-12-12-10OG | M12X1.5 | M10X1 | 6 | O08.1X1.6 | 13 | 28 | 26.5 | 11 | 14 | 14 | 31.5 轻系列 L |
| ACCH-14-14-12OG | M14X1.5 | M12X1.5 | 8 | O09.3X2.4 | 15.5 | 30.5 | 32 | 14 | 17 | 17 | |
| ACCH-16-16-14OG | M16X1.5 | M14X1.5 | 10 | O11.3X2.4 | 17.5 | 32.5 | 34 | 16 | 19 | 19 | |
| ACCH-18-18-16OG | M18X1.5 | M16X1.5 | 12 | O13.3X2.4 | 19 | 34 | 36 | 19 | 22 | 22 | |
| ACCH-22-22-18OG | M22X1.5 | M18X1.5 | 15 | O15.3X2.4 | 22 | 37 | 39.5 | 22 | 27 | 24 | |
| ACCH-26-26-22OG | M26X1.5 | M22X1.5 | 18 | O19.3X2.4 | 25.5 | 42 | 43.5 | 27 | 32 | 27 | |
| ACCH-30-30-27OG | M30X2 | M27X2 | 22 | O23.5X3.0 | 29.3 | 45.8 | 50 | 30 | 36 | 32 | 16 轻系列 |
| ACCH-36-36-33OG | M36X2 | M33X2 | 28 | O29.2X3.0 | 33.3 | 49.8 | 54 | 36 | 41 | 41 | |
| ADDH-14-14-12OG | M14X1.5 | M12X1.5 | 6 | O09.3X2.4 | 17.5 | 32.5 | 32 | 14 | 17 | 17 | 63 重系列 S |
| ADDH-16-16-14OG | M16X1.5 | M14X1.5 | 8 | O11.3X2.4 | 18.7 | 33.7 | 34 | 16 | 19 | 19 | |
| ADDH-18-18-16OG | M18X1.5 | M16X1.5 | 10 | O13.3X2.4 | 19.5 | 36 | 36 | 19 | 22 | 22 | |
| ADDH-20-20-18OG | M20X1.5 | M18X1.5 | 12 | O15.3X2.4 | 19.5 | 36 | 37 | 19 | 24 | 24 | |
| ADDH-24-24-22OG | M24X1.5 | M22X1.5 | 16 | O19.3X2.4 | 24 | 42 | 37.5 | 24 | 30 | 27 | |
| ADDH-30-30-27OG | M30X2 | M27X2 | 20 | O23.5X3.0 | 28.3 | 49.8 | 50 | 30 | 36 | 32 | 40 重系列 S |
| ADDH-36-36-33OG | M36X2 | M33X2 | 25 | O29.2X3.0 | 32.8 | 56.8 | 54 | 36 | 46 | 41 | |
| ADDH-42-42-42OG | M42X2 | M42X2 | 30 | O38.5X3.0 | 36.2 | 62.7 | 57.2 | 41 | 50 | 50 | |

注：1 如需带卡套及卡套螺母整套订货，则请在代号后加“RN”，如ACCH-30-30-27OGRN。

2 G端与ISO 9974-1油口相配，去掉挡圈则与ISO 6149-1油口相配。

Note: 1 In case if you are interested to order the adapter in complete set with cutting ring and nut ,it is necessary to insert suffix "RN" after our part no., for example ACCH-30-30-27OGRN. 2 G end is connected with ISO 9974-1 port and connected with ISO 6149-1 port without retaining ring.

DIN卡套接头 DIN Bite Type Tube Fittings

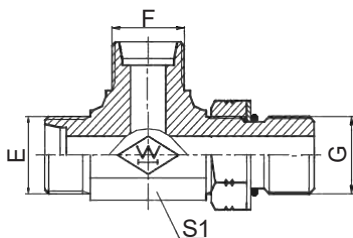

ACCO-OG
ADD-OG

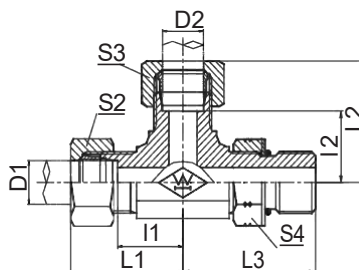

ACCO-OG/RN
ADD-OG/RN

三通右端美制螺纹可调向O形圈密封
BARREL TEE UN、UNF THREAD ADJUSTABLE
STUD ENDS WITH O-RING SEALING

| 代号 PART NO. | 螺 纹 THREAD | | 管子外径 TUBE O.D. | 尺 寸 DIMENSIONS | | | | | | 压力等级 MPa |
|-----------------|------------|------------|----------------|----------------|-------|-------|----|----|-------|------------------|
| | E,F | G | | D1,D2 | I1,I2 | L1,L2 | L3 | S1 | S2,S3 | |
| ACCO-12-12-04OG | M12X1.5 | 7/16"X20 | 6 | 13 | 28 | 27.2 | 11 | 14 | 17 | 31.5 轻系列 L |
| ACCO-14-14-06OG | M14X1.5 | 9/16"X18 | 8 | 15.5 | 30.5 | 31.8 | 14 | 17 | 19 | |
| ACCO-16-16-06OG | M16X1.5 | 9/16"X18 | 10 | 17.5 | 32.5 | 33.3 | 16 | 19 | 19 | |
| ACCO-18-18-08OG | M18X1.5 | 3/4"X16 | 12 | 19 | 34 | 37.5 | 19 | 22 | 24 | |
| ACCO-22-22-10OG | M22X1.5 | 7/8"X14 | 15 | 22 | 37 | 44 | 22 | 27 | 27 | |
| ACCO-26-26-12OG | M26X1.5 | 1.1/16"X12 | 18 | 25.5 | 42 | 51 | 27 | 32 | 32 | |
| ACCO-30-30-12OG | M30X2 | 1.1/16"X12 | 22 | 29.3 | 45.8 | 53.5 | 30 | 36 | 32 | 16 轻系列 L |
| ACCO-36-36-16OG | M36X2 | 1.5/16"X12 | 28 | 33.3 | 49.8 | 57.5 | 36 | 41 | 41 | |
| ACCO-45-45-20OG | M45X2 | 1.5/8"X12 | 35 | 39.2 | 60.7 | 63 | 48 | 50 | 50 | |
| ADDO-14-14-04OG | M14X1.5 | 7/16"X20 | 6 | 17.5 | 32.5 | 30 | 14 | 17 | 17 | 63 重系列 S |
| ADDO-16-16-06OG | M16X1.5 | 9/16"X18 | 8 | 18.7 | 33.7 | 33.3 | 16 | 19 | 19 | |
| ADDO-18-18-06OG | M18X1.5 | 9/16"X18 | 10 | 19.5 | 36 | 33.5 | 19 | 22 | 19 | |
| ADDO-20-20-08OG | M20X1.5 | 3/4"X16 | 12 | 19.5 | 36 | 37.5 | 19 | 24 | 24 | |
| ADDO-22-22-10OG | M22X1.5 | 7/8"X14 | 14 | 23 | 41 | 44 | 22 | 27 | 27 | 40 重系列 S |
| ADDO-24-24-10OG | M24X1.5 | 7/8"X14 | 16 | 24 | 42.5 | 46.5 | 24 | 30 | 27 | |
| ADDO-30-30-12OG | M30X2 | 1.1/16"X12 | 20 | 28.3 | 49.8 | 53.5 | 30 | 36 | 32 | |
| ADDO-36-36-16OG | M36X2 | 1.5/16"X12 | 25 | 32.8 | 56.8 | 57.5 | 36 | 46 | 41 | |
| ADDO-42-42-20OG | M42X2 | 1.5/8"X12 | 30 | 36.2 | 62.7 | 59.5 | 41 | 50 | 50 | |

注：如需带卡套及卡套螺母整套订货，则请在代号后加“RN”，如ACCO-30-30-12OGRN。
Note: In case if you are interested to order the adapter in complete set with cutting ring and nut ,it is necessary to insert suffix "RN" after our part no. , for example ACCO-30-30-12OGRN.

DIN卡套接头 DIN Bite Type Tube Fittings

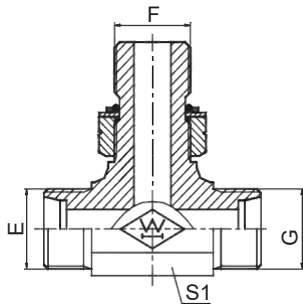

**ACHC-OG
ADHD-OG**

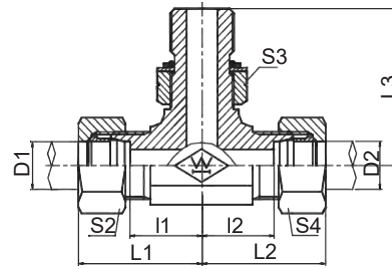

**ACHC-OG/RN
ADHD-OG/RN**

公制外螺纹24° 锥 / 公制外螺纹
可调向柱端ISO 6149分支三通

METRIC MALE 24° CONE / METRIC MALE
ADJUSTABLE STUD END ISO 6149 BRANCH TEE

| 代号 PART NO. | 螺 纹 THREAD | | 管子外径 D1,D2 TUBE O.D. | O形圈 O-RING | 尺 寸 DIMENSIONS | | | | | | 压力等级 MPa |
|-----------------|------------|---------|----------------------------|---------------|----------------|-------|------|----|-------|----|------------------|
| | E,G | F | | | I1,I2 | L1,L2 | L3 | S1 | S2,S4 | S3 | |
| ACHC-12-10-12OG | M12X1.5 | M10X1 | 6 | O08.1X1.6 | 13 | 28 | 26.5 | 11 | 14 | 14 | 31.5 轻系列 L |
| ACHC-14-12-14OG | M14X1.5 | M12X1.5 | 8 | O09.3X2.4 | 15.5 | 30.5 | 32 | 14 | 17 | 17 | |
| ACHC-16-14-16OG | M16X1.5 | M14X1.5 | 10 | O11.3X2.4 | 17.5 | 32.5 | 34 | 16 | 19 | 19 | |
| ACHC-18-16-18OG | M18X1.5 | M16X1.5 | 12 | O13.3X2.4 | 19 | 34 | 36 | 19 | 22 | 22 | |
| ACHC-22-18-22OG | M22X1.5 | M18X1.5 | 15 | O15.3X2.4 | 22 | 37 | 39.5 | 22 | 27 | 24 | |
| ACHC-26-22-26OG | M26X1.5 | M22X1.5 | 18 | O19.3X2.4 | 25.5 | 42 | 43.5 | 27 | 32 | 27 | |
| ACHC-30-27-30OG | M30X2 | M27X2 | 22 | O23.5X3.0 | 29.3 | 45.8 | 50 | 30 | 36 | 32 | 16 |
| ACHC-36-33-36OG | M36X2 | M33X2 | 28 | O29.2X3.0 | 33.3 | 49.8 | 54 | 36 | 41 | 41 | 轻系列 |
| ADHD-14-12-14OG | M14X1.5 | M12X1.5 | 6 | O09.3X2.4 | 17.5 | 32.5 | 32 | 14 | 17 | 17 | 63 重系列 S |
| ADHD-16-14-16OG | M16X1.5 | M14X1.5 | 8 | O11.3X2.4 | 18.7 | 33.7 | 34 | 16 | 19 | 19 | |
| ADHD-18-16-18OG | M18X1.5 | M16X1.5 | 10 | O13.3X2.4 | 19.5 | 36 | 36 | 19 | 22 | 22 | |
| ADHD-20-18-20OG | M20X1.5 | M18X1.5 | 12 | O15.3X2.4 | 19.5 | 36 | 37 | 19 | 24 | 24 | |
| ADHD-24-22-24OG | M24X1.5 | M22X1.5 | 16 | O19.3X2.4 | 24 | 42 | 37.5 | 24 | 30 | 27 | 40 重系列 S |
| ADHD-30-27-30OG | M30X2 | M27X2 | 20 | O23.5X3.0 | 28.3 | 49.8 | 50 | 30 | 36 | 32 | |
| ADHD-36-33-36OG | M36X2 | M33X2 | 25 | O29.2X3.0 | 32.8 | 56.8 | 54 | 36 | 46 | 41 | |
| ADHD-42-42-42OG | M42X2 | M42X2 | 30 | O38.5X3.0 | 36.2 | 62.7 | 57.2 | 41 | 50 | 50 | |

注： 1 如需带卡套及卡套螺母整套订货，则请在代号后加“RN”，如ACHC-30-27-30OGRN。

2 F端与ISO 9974-1油口相配，去掉挡圈则与ISO 6149-1油口相配。

Note: 1 In case if you are interested to order the adapter in complete set with cutting ring and nut ,it is necessary to insert suffix "RN" after our part no. , for example ACHC-30-27-30OGRN. 2 F end is connected with ISO 9974-1 port and connected with ISO 6149-1 port without retaining ring.

DIN卡套接头 DIN Bite Type Tube Fittings

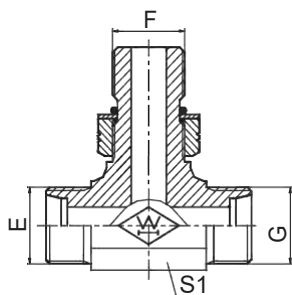

ACOC-OG
ADOD-OG

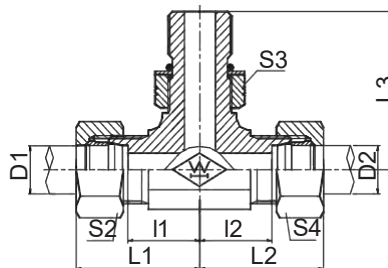

ACOC-OG/RN
ADOD-OG/RN

三通中间端美制螺纹可调向O形圈密封
BRANCH TEE UN、UNF THREAD ADJUSTABLE
STUD ENDS WITH O-RING SEALING

| 代号 PART NO. | 螺 纹 | THREAD | 管子外径 TUBE O.D. | 尺 寸 DIMENSIONS | | | | | | 压力等级 |
|-----------------|---------|------------|----------------|----------------|-------|------|----|-------|----|------------------|
| | E,G | F | D1,D2 | I1,I2 | L1,L2 | L3 | S1 | S2,S4 | S3 | MPa |
| ACOC-12-04-12OG | M12X1.5 | 7/16"X20 | 6 | 13 | 28 | 27.2 | 11 | 14 | 17 | 31.5 轻系列 L |
| ACOC-14-06-14OG | M14X1.5 | 9/16"X18 | 8 | 15.5 | 30.5 | 31.8 | 14 | 17 | 19 | |
| ACOC-16-06-16OG | M16X1.5 | 9/16"X18 | 10 | 17.5 | 32.5 | 33.3 | 16 | 19 | 19 | |
| ACOC-18-08-18OG | M18X1.5 | 3/4"X16 | 12 | 19 | 34 | 37.5 | 19 | 22 | 24 | |
| ACOC-22-10-22OG | M22X1.5 | 7/8"X14 | 15 | 22 | 37 | 44 | 22 | 27 | 27 | |
| ACOC-26-12-26OG | M26X1.5 | 1.1/16"X12 | 18 | 25.5 | 42 | 51 | 27 | 32 | 32 | |
| ACOC-30-12-30OG | M30X2 | 1.1/16"X12 | 22 | 29.3 | 45.8 | 53.5 | 30 | 36 | 32 | 16 轻系列 L |
| ACOC-36-16-36OG | M36X2 | 1.5/16"X12 | 28 | 33.3 | 49.8 | 57.5 | 36 | 41 | 41 | |
| ACOC-45-20-45OG | M45X2 | 1.5/8"X12 | 35 | 39.2 | 60.7 | 63 | 48 | 50 | 50 | |
| ADOD-14-04-14OG | M14X1.5 | 7/16"X20 | 6 | 17.5 | 32.5 | 30 | 14 | 17 | 17 | 63 重系列 S |
| ADOD-16-06-16OG | M16X1.5 | 9/16"X18 | 8 | 18.7 | 33.7 | 33.3 | 16 | 19 | 19 | |
| ADOD-18-06-18OG | M18X1.5 | 9/16"X18 | 10 | 19.5 | 36 | 33.5 | 19 | 22 | 19 | |
| ADOD-20-08-20OG | M20X1.5 | 3/4"X16 | 12 | 19.5 | 36 | 37.5 | 19 | 24 | 24 | |
| ADOD-22-10-22OG | M22X1.5 | 7/8"X14 | 14 | 23 | 41 | 44 | 22 | 27 | 27 | |
| ADOD-24-10-24OG | M24X1.5 | 7/8"X14 | 16 | 24 | 42.5 | 46.5 | 24 | 30 | 27 | |
| ADOD-30-12-30OG | M30X2 | 1.1/16"X12 | 20 | 28.3 | 49.8 | 53.5 | 30 | 36 | 32 | 40 重系列 S |
| ADOD-36-16-36OG | M36X2 | 1.5/16"X12 | 25 | 32.8 | 56.8 | 57.5 | 36 | 46 | 41 | |
| ADOD-42-20-42OG | M42X2 | 1.5/8"X12 | 30 | 36.2 | 62.7 | 59.5 | 41 | 50 | 50 | |

注：如需带卡套及卡套螺母整套订货，则请在代号后加“RN”，如ACOC-30-12-30OGRN。

Note: In case if you are interested to order the adapter in complete set with cutting ring and nut, it is necessary to insert suffix "RN" after our part no., for example ACOC-30-12-30OGRN.

DIN卡套接头 DIN Bite Type Tube Fittings

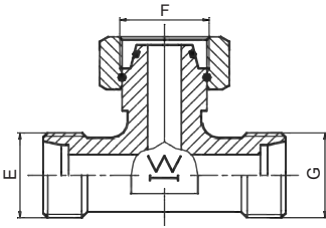

**BC
BD**

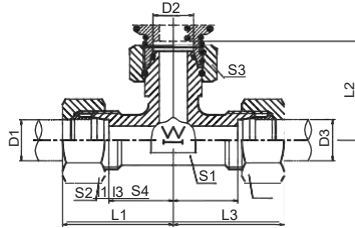

**BC-RN
BD-RN**

中间端内螺纹三通接头
BRANCH TEE FITTINGS
WITH SWIVEL NUT

| 代号 PART NO. | 螺 纹 THREAD | | 管子外径 TUBE O.D. | | 尺 寸 DIMENSIONS | | | | | | 压力等级 MPa |
|----------------|------------|---------|----------------|----|----------------|-------|------|----|-------|----|------------------|
| | E,G | F | D1,D3 | D2 | I1,I3 | L1,L3 | L2 | S1 | S2,S4 | S3 | |
| BC-12 | M12X1.5 | M12X1.5 | 6 | 6 | 12 | 27 | 26 | 12 | 14 | 14 | 31.5 轻系列 L |
| BC-14 | M14X1.5 | M14X1.5 | 8 | 8 | 14 | 29 | 27.5 | 12 | 17 | 17 | |
| BC-16 | M16X1.5 | M16X1.5 | 10 | 10 | 15 | 30 | 29 | 14 | 19 | 19 | |
| BC-18 | M18X1.5 | M18X1.5 | 12 | 12 | 17 | 32 | 29.5 | 17 | 22 | 22 | |
| BC-22 | M22X1.5 | M22X1.5 | 15 | 15 | 21 | 36 | 32.5 | 19 | 27 | 27 | |
| BC-26 | M26X1.5 | M26X1.5 | 18 | 18 | 23.5 | 40 | 35.5 | 24 | 32 | 32 | |
| BC-30 | M30X2 | M30X2 | 22 | 22 | 27.5 | 44 | 38.5 | 27 | 36 | 36 | 16 轻系列L |
| BC-36 | M36X2 | M36X2 | 28 | 28 | 30.5 | 47 | 41.5 | 36 | 41 | 41 | |
| BC-45 | M45X2 | M45X2 | 35 | 35 | 34.5 | 56 | 51 | 41 | 50 | 50 | |
| BC-52 | M52X2 | M52X2 | 42 | 42 | 40 | 63 | 56 | 50 | 60 | 60 | |
| BD-14 | M14X1.5 | M14X1.5 | 6 | 6 | 16 | 31 | 27 | 12 | 17 | 17 | 63 重系列 S |
| BD-16 | M16X1.5 | M16X1.5 | 8 | 8 | 17 | 32 | 27.5 | 14 | 19 | 19 | |
| BD-18 | M18X1.5 | M18X1.5 | 10 | 10 | 17.5 | 34 | 30 | 17 | 22 | 22 | |
| BD-20 | M20X1.5 | M20X1.5 | 12 | 12 | 21.5 | 38 | 31 | 17 | 24 | 24 | |
| BD-22 | M22X1.5 | M22X1.5 | 14 | 14 | 22 | 40 | 35 | 19 | 27 | 27 | |
| BD-24 | M24X1.5 | M24X1.5 | 16 | 16 | 24.5 | 43 | 36.5 | 24 | 30 | 30 | 40 重系列 S |
| BD-30 | M30X2 | M30X2 | 20 | 20 | 26.5 | 48 | 44.5 | 27 | 36 | 36 | |
| BD-36 | M36X2 | M36X2 | 25 | 25 | 30 | 54 | 50 | 36 | 46 | 46 | |
| BD-42 | M42X2 | M42X2 | 30 | 30 | 35.5 | 62 | 55 | 41 | 50 | 50 | |
| BD-52 | M52X2 | M52X2 | 38 | 38 | 41 | 72 | 63 | 50 | 60 | 60 | |

注：如需带卡套及卡套螺母整套订货，则请在代号后加“RN”，如BC-30RN。

Note: In case if you are interested to order the adapter in complete set with cutting ring and nut ,it is necessary to insert suffix "RN" after our part no.,for example BC-30RN.

DIN卡套接头 DIN Bite Type Tube Fittings

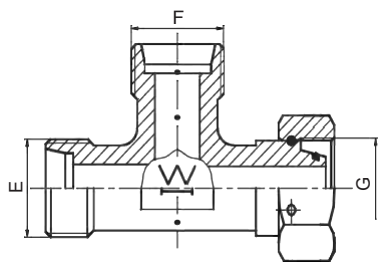

CC
CD

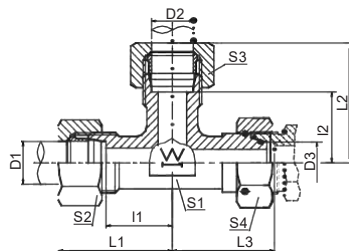

CC-RN
CD-RN

右端内螺纹三通接头
BARREL TEE FITTINGS
WITH SWIVEL NUT

| 代号 PART NO. | 螺 纹 THREAD | | 管子外径 TUBE O.D. | | 尺 寸 DIMENSIONS | | | | | | 压力等级 MPa |
|----------------|------------|---------|----------------|----|----------------|-------|------|----|-------|----|------------------|
| | E,F | G | D1,D2 | D3 | I1,I2 | L1,L2 | L3 | S1 | S2,S3 | S4 | |
| CC-12 | M12X1.5 | M12X1.5 | 6 | 6 | 12 | 27 | 26 | 12 | 14 | 14 | 31.5 轻系列 L |
| CC-14 | M14X1.5 | M14X1.5 | 8 | 8 | 14 | 29 | 27.5 | 12 | 17 | 17 | |
| CC-16 | M16X1.5 | M16X1.5 | 10 | 10 | 15 | 30 | 29 | 14 | 19 | 19 | |
| CC-18 | M18X1.5 | M18X1.5 | 12 | 12 | 17 | 32 | 29.5 | 17 | 22 | 22 | |
| CC-22 | M22X1.5 | M22X1.5 | 15 | 15 | 21 | 36 | 32.5 | 19 | 27 | 27 | |
| CC-26 | M26X1.5 | M26X1.5 | 18 | 18 | 23.5 | 40 | 35.5 | 24 | 32 | 32 | |
| CC-30 | M30X2 | M30X2 | 22 | 22 | 27.5 | 44 | 38.5 | 27 | 36 | 36 | 16 轻系列 L |
| CC-36 | M36X2 | M36X2 | 28 | 28 | 30.5 | 47 | 41.5 | 36 | 41 | 41 | |
| CC-45 | M45X2 | M45X2 | 35 | 35 | 34.5 | 56 | 51 | 41 | 50 | 50 | |
| CC-52 | M52X2 | M52X2 | 42 | 42 | 40 | 63 | 56 | 50 | 60 | 60 | 63 重系列 S |
| CD-14 | M14X1.5 | M14X1.5 | 6 | 6 | 16 | 31 | 27 | 12 | 17 | 17 | |
| CD-16 | M16X1.5 | M16X1.5 | 8 | 8 | 17 | 32 | 27.5 | 14 | 19 | 19 | |
| CD-18 | M18X1.5 | M18X1.5 | 10 | 10 | 17.5 | 34 | 30 | 17 | 22 | 22 | |
| CD-20 | M20X1.5 | M20X1.5 | 12 | 12 | 21.5 | 38 | 31 | 17 | 24 | 24 | |
| CD-22 | M22X1.5 | M22X1.5 | 14 | 14 | 22 | 40 | 35 | 19 | 27 | 27 | |
| CD-24 | M24X1.5 | M24X1.5 | 16 | 16 | 24.5 | 43 | 36.5 | 24 | 30 | 30 | 40 重系列 S |
| CD-30 | M30X2 | M30X2 | 20 | 20 | 26.5 | 48 | 44.5 | 27 | 36 | 36 | |
| CD-36 | M36X2 | M36X2 | 25 | 25 | 30 | 54 | 50 | 36 | 46 | 46 | |
| CD-42 | M42X2 | M42X2 | 30 | 30 | 35.5 | 62 | 55 | 41 | 50 | 50 | |
| CD-52 | M52X2 | M52X2 | 38 | 38 | 41 | 72 | 63 | 50 | 60 | 60 | 31.5重系列S |

注：如需带卡套及卡套螺母整套订货，则请在代号后加“RN”，如CC-30RN。

Note: In case if you are interested to order the adapter in complete set with cutting ring and nut ,it is necessary to insert suffix "RN" after our part no., for example CC-30RN.

DIN卡套接头 DIN Bite Type Tube Fittings

B

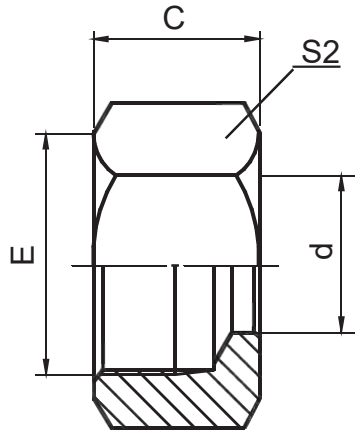

**NL
NS**

卡套螺母
RETAINING NUTS

| 代号 PART NO. | 螺 纹 | THREAD | 管子外径 | 尺 寸 | | | | | | 压力等级 MPa |
|----------------|---------|--------|-----------|------|----|----|--|--|--|-------------|
| | E | | TUBE O.D. | C | d | S2 | | | | |
| NL-12 | M12X1.5 | | 6 | 14.5 | 6 | 14 | | | | 轻系列 L |
| NL-14 | M14X1.5 | | 8 | 14.5 | 8 | 17 | | | | |
| NL-16 | M16X1.5 | | 10 | 15.5 | 10 | 19 | | | | |
| NL-18 | M18X1.5 | | 12 | 15.5 | 12 | 22 | | | | |
| NL-22 | M22X1.5 | | 15 | 17 | 15 | 27 | | | | |
| NL-26 | M26X1.5 | | 18 | 18 | 18 | 32 | | | | |
| NL-30 | M30X2 | | 22 | 20 | 22 | 36 | | | | |
| NL-30D | M30X1.5 | | 22 | 19 | 22 | 36 | | | | |
| NL-36 | M36X2 | | 28 | 21 | 28 | 41 | | | | |
| NL-36D | M36X1.5 | | 28 | 21 | 28 | 41 | | | | |
| NL-45 | M45X2 | | 35 | 24 | 35 | 50 | | | | |
| NL-45D | M45X1.5 | | 35 | 25 | 35 | 50 | | | | |
| NL-52 | M52X2 | | 42 | 24 | 42 | 60 | | | | |
| NS-14 | M14X1.5 | | 6 | 16.5 | 6 | 17 | | | | |
| NS-16 | M16X1.5 | | 8 | 16.5 | 8 | 19 | | | | |
| NS-18 | M18X1.5 | | 10 | 17.5 | 10 | 22 | | | | |
| NS-20 | M20X1.5 | | 12 | 17.5 | 12 | 24 | | | | |
| NS-22 | M22X1.5 | | 14 | 20.5 | 14 | 27 | | | | |
| NS-24 | M24X1.5 | | 16 | 20.5 | 16 | 30 | | | | |
| NS-30 | M30X2 | | 20 | 24 | 20 | 36 | | | | |
| NS-36 | M36X2 | | 25 | 27 | 25 | 46 | | | | |
| NS-42 | M42X2 | | 30 | 29 | 30 | 50 | | | | |
| NS-52 | M52X2 | | 38 | 32.5 | 38 | 60 | | | | |

DIN卡套接头 DIN Bite Type Tube Fittings

B

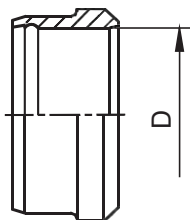





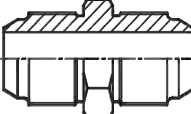

**RL
RS**

卡套
CUTTING RING

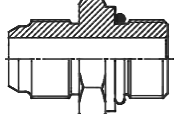
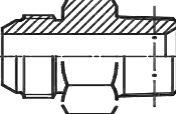
| 代号 PART NO. | | | 管子外径 TUBE O.D. | | 尺寸 DIMENSIONS | | | | 备注 |
|----------------|--|--|----------------|--|---------------|--|--|--|----------|
| | | | | | | | | | |
| RL-06 | | | 6 | | 与重系列相应规格一致 | | | | 轻系列 L |
| RL-08 | | | 8 | | | | | | |
| RL-10 | | | 10 | | | | | | |
| RL-12 | | | 12 | | | | | | |
| RL-15 | | | 15 | | | | | | |
| RL-18 | | | 18 | | | | | | |
| RL-22 | | | 22 | | | | | | |
| RL-28 | | | 28 | | | | | | |
| RL-35 | | | 35 | | | | | | |
| RL-42 | | | 42 | | | | | | |
| RS-06 | | | 6 | | | | | | 重系列 S |
| RS-08 | | | 8 | | | | | | |
| RS-10 | | | 10 | | | | | | |
| RS-12 | | | 12 | | | | | | |
| RS-14 | | | 14 | | | | | | |
| RS-16 | | | 16 | | | | | | |
| RS-20 | | | 20 | | | | | | |
| RS-25 | | | 25 | | | | | | |
| RS-30 | | | 30 | | | | | | |
| RS-38 | | | 38 | | | | | | |

型号索引 Part NO. Index

| | | | | | |
|---|--|--|---|---|---|
|  <p>1K PC1</p> |  <p>1KG PC1</p> |  <p>1KH PC2</p> |  <p>1KN PC2</p> |  <p>1KT-SP PC3</p> |  <p>4K PC3</p> |
|  <p>9K PC4</p> | | | | | |
| | | | | | |
| | | | | | |
| | | | | | |
| | | | | | |
| | | | | | |

日本公制螺纹60° 锥面密封接头 Japanese Metric Thread 60° Cone Fittings

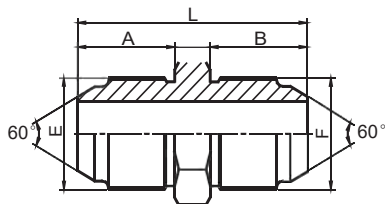

1K

日本公制外螺纹60° 外锥
JIS METRIC MALE 60° CONE

C

| 代号 PART NO. | 螺纹 THREAD | | 尺寸 DIMENSIONS | | | | | |
|----------------|-----------|---------|---------------|--|------|------|----|----|
| | E | F | | | A | B | L | S1 |
| 1K-14 | M14X1.5 | M14X1.5 | | | 17 | 17 | 40 | 17 |
| 1K-16 | M16X1.5 | M16X1.5 | | | 18 | 18 | 42 | 17 |
| 1K-18 | M18X1.5 | M18X1.5 | | | 18 | 18 | 42 | 19 |
| 1K-20 | M20X1.5 | M20X1.5 | | | 20 | 20 | 48 | 22 |
| 1K-22 | M22X1.5 | M22X1.5 | | | 20 | 20 | 48 | 24 |
| 1K-24 | M24X1.5 | M24X1.5 | | | 21.5 | 21.5 | 53 | 27 |
| 1K-30 | M30X1.5 | M30X1.5 | | | 26 | 26 | 63 | 32 |
| 1K-33 | M33X1.5 | M33X1.5 | | | 30 | 30 | 71 | 36 |
| 1K-36 | M36X1.5 | M36X1.5 | | | 33 | 33 | 79 | 41 |
| 1K-42 | M42X1.5 | M42X1.5 | | | 36 | 36 | 85 | 46 |

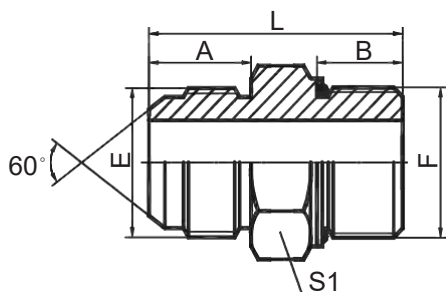

1KG

日本公制外螺纹60° 外锥 / 英管外螺纹O形圈
JIS METRIC MALE 60° CONE / BSP MALE O-RING

| 代号 PART NO. | 螺纹 THREAD | | O形圈 O-RING | | 尺寸 DIMENSIONS | | | | |
|----------------|-----------|----------|------------|------|---------------|------|------|----|--|
| | E | F | | F端 | A | B | L | S | |
| 1KG-14-04 | M14X1.5 | G1/4"X19 | | O111 | 17 | 11 | 36 | 19 | |
| 1KG-14-06 | M14X1.5 | G3/8"X19 | | O113 | 17 | 11.5 | 36.5 | 24 | |
| 1KG-16-06 | M16X1.5 | G3/8"X19 | | O113 | 18 | 11.5 | 38 | 24 | |
| 1KG-18-06 | M18X1.5 | G3/8"X19 | | O113 | 18 | 11.5 | 38 | 24 | |
| 1KG-22-08 | M22X1.5 | G1/2"X14 | | O115 | 20 | 14 | 45.5 | 27 | |
| 1KG-30-12 | M30X1.5 | G3/4"X14 | | O119 | 26 | 15.5 | 52.5 | 36 | |
| 1KG-33-12 | M33X1.5 | G3/4"X14 | | O119 | 30 | 15.5 | 58 | 36 | |
| 1KG-33-16 | M33X1.5 | G1"X1 | | O217 | 30 | 18 | 62 | 4 | |

注：F端与DIN 3852油口相配。 Note: F end is connected with DIN 3852 port.

日本公制螺纹60° 锥面密封接头 Japanese Metric Thread 60° Cone Fittings

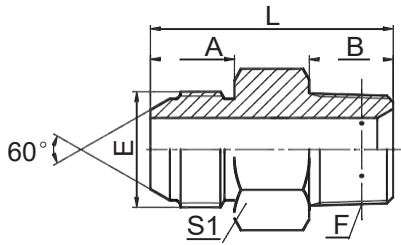

1KN

日本公制外螺纹60° 外锥/布锥管外螺纹
JIS METRIC MALE 60° CONE/NPT MALE

| 代号 PART NO. | 螺纹 THREAD | | 尺寸 DIMENSIONS | | | | |
|----------------|-----------|--------------|---------------|------|------|----|--|
| | E | F | A | B | L | S1 | |
| 1KN-14-04 | M14X1.5 | Z1/4"X18 | 17 | 15 | 38 | 17 | |
| 1KN-14-06 | M14X1.5 | Z3/8"X18 | 17 | 16 | 39 | 19 | |
| 1KN-16-06 | M16X1.5 | Z3/8"X18 | 18 | 16 | 40 | 19 | |
| 1KN-16-08 | M16X1.5 | Z1/2"X14 | 18 | 19.5 | 45.5 | 22 | |
| 1KN-18-06 | M18X1.5 | Z3/8"X18 | 18 | 16 | 40 | 19 | |
| 1KN-20-06 | M20X1.5 | Z3/8"X18 | 20 | 16 | 44 | 22 | |
| 1KN-20-08 | M20X1.5 | Z1/2"X14 | 20 | 19.5 | 47.5 | 22 | |
| 1KN-22-08 | M22X1.5 | Z1/2"X14 | 20 | 19.5 | 47.5 | 24 | |
| 1KN-24-08 | M24X1.5 | Z1/2"X14 | 21.5 | 19.5 | 51 | 27 | |
| 1KN-24-12 | M24X1.5 | Z3/4"X14 | 21.5 | 19.5 | 51 | 30 | |
| 1KN-30-12 | M30X1.5 | Z3/4"X14 | 26 | 19.5 | 56.5 | 32 | |
| 1KN-33-16 | M33X1.5 | Z1"X11.5 | 30 | 25.5 | 66.5 | 36 | |
| 1KN-36-20 | M36X1.5 | Z1.1/4"X11.5 | 33 | 26.5 | 72.5 | 46 | |
| 1KN-42-24 | M42X1.5 | Z1.1/2"X11.5 | 36 | 27.5 | 78.5 | 50 | |

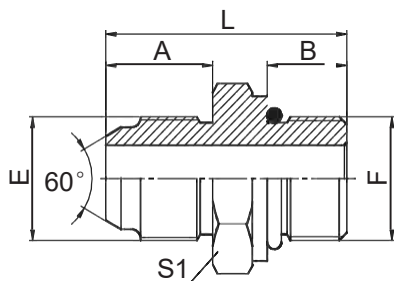

1KH

日本公制外螺纹60° 外锥 /
公制外螺纹可调向柱端重系列ISO 6149-2
JIS METRIC MALE 60° CONE / METIRC MALE
ADJUSTABLE STUD END S-SERIES ISO 6149-2

| 代号 PART NO. | 螺纹 THREAD | | O形圈 O-RING | | 尺寸 DIMENSIONS | | | |
|----------------|-----------|---------|------------|--|---------------|------|------|----|
| | E | F | F端 | | A | B | L | S1 |
| 1KH-14-12 | M14X1.5 | M12X1.5 | O09.3X2.4 | | 17 | 11.0 | 36.5 | 17 |
| 1KH-14 | M14X1.5 | M14X1.5 | O11.3X2.4 | | 17 | 11.0 | 35.5 | 19 |
| 1KH-16-14 | M16X1.5 | M14X1.5 | O11.3X2.4 | | 18 | 11.0 | 40 | 19 |
| 1KH-18-14 | M18X1.5 | M14X1.5 | O11.3X2.4 | | 18 | 11.0 | 37.5 | 19 |
| 1KH-18-16 | M18X1.5 | M16X1.5 | O13.3X2.4 | | 18 | 11.5 | 40 | 22 |
| 1KH-18-20 | M18X1.5 | M20X1.5 | O17.3X2.4 | | 18 | 14.0 | 45 | 27 |
| 1KH-20-18 | M20X1.5 | M18X1.5 | O15.3X2.4 | | 20 | 14.0 | 47 | 24 |
| 1KH-22-20 | M22X1.5 | M20X1.5 | O17.3X2.4 | | 20 | 14.0 | 47 | 27 |
| 1KH-24-20 | M24X1.5 | M20X1.5 | O17.3X2.4 | | 21.5 | 14.0 | 48.5 | 27 |
| 1KH-24-22 | M24X1.5 | M22X1.5 | O19.3X2.4 | | 21.5 | 13.0 | 45 | 27 |
| 1KH-30-27 | M30X1.5 | M27X2 | O23.5X3.0 | | 26 | 18.5 | 60.5 | 32 |
| 1KH-33 | M33X1.5 | M33X2 | O29.5X3.0 | | 30 | 18.5 | 65 | 41 |
| 1KH-36-33 | M36X1.5 | M33X2 | O29.5X3.0 | | 33 | 18.5 | 68 | 41 |

注： F端与ISO 6149-1 油口相配。 Note: F end is fit for ISO 6149-1 port.

日本公制螺纹60° 锥面密封接头 Japanese Metric Thread 60° Cone Fittings

C

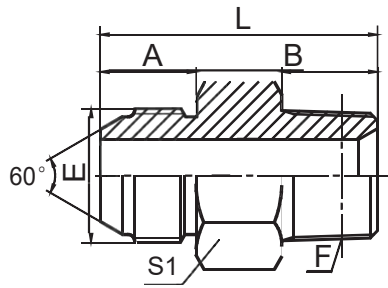

1KT-SP

公制外螺纹60° 外锥 / 英锥管外螺纹
METRIC MALE 60° CONE / BSPT MALE

| 代号 PART NO. | 螺纹 THREAD | | 尺寸 DIMENSIONS | | | | |
|----------------|-----------|------------|---------------|------|------|----|--|
| | E | F | A | B | L | S1 | |
| 1KT-14-04SP | M14X1.5 | R1/4"X19 | 17 | 14.5 | 37.5 | 14 | |
| 1KT-14-06SP | M14X1.5 | R3/8"X19 | 17 | 15 | 38 | 17 | |
| 1KT-16-06SP | M16X1.5 | R3/8"X19 | 18 | 15 | 39 | 17 | |
| 1KT-18-06SP | M18X1.5 | R3/8"X19 | 18 | 15 | 39 | 19 | |
| 1KT-20-06SP | M20X1.5 | R3/8"X19 | 20 | 15 | 43 | 22 | |
| 1KT-22-06SP | M22X1.5 | R3/8"X19 | 20 | 15 | 43 | 24 | |
| 1KT-22-08SP | M22X1.5 | R1/2"X14 | 20 | 20 | 48 | 24 | |
| 1KT-24-08SP | M24X1.5 | R1/2"X14 | 21.5 | 20 | 51.5 | 27 | |
| 1KT-24-12SP | M24X1.5 | R3/4"X14 | 21.5 | 20 | 51.5 | 30 | |
| 1KT-30-12SP | M30X1.5 | R3/4"X14 | 26 | 20 | 57 | 32 | |
| 1KT-33-16SP | M33X1.5 | R1"X11 | 30 | 25.5 | 66.5 | 36 | |
| 1KT-36-20SP | M36X1.5 | R1.1/4"X11 | 33 | 26.5 | 72.5 | 46 | |
| 1KT-42-24SP | M42X1.5 | R1.1/2"X11 | 36 | 26.5 | 77.5 | 50 | |

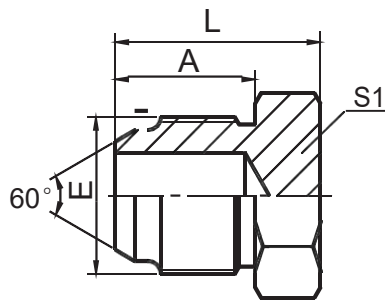

4K

日本公制外螺纹60° 外锥堵头
JIS METRIC MALE 60° CONE PLUG

| 代号 PART NO. | 螺纹 THREAD | | 尺寸 DIMENSIONS | | |
|----------------|-----------|--|---------------|------|----|
| | E | | A | L | S1 |
| 4K-14 | M14X1.5 | | 17 | 23 | 17 |
| 4K-16 | M16X1.5 | | 18 | 24 | 17 |
| 4K-18 | M18X1.5 | | 18 | 25 | 19 |
| 4K-20 | M20X1.5 | | 20 | 28 | 22 |
| 4K-22 | M22X1.5 | | 20 | 28 | 24 |
| 4K-24 | M24X1.5 | | 21.5 | 31.5 | 27 |
| 4K-30 | M30X1.5 | | 26 | 37 | 32 |
| 4K-33 | M33X1.5 | | 30 | 41 | 36 |

日本公制螺纹60° 锥面密封接头 Japanese Metric Thread 60° Cone Fittings

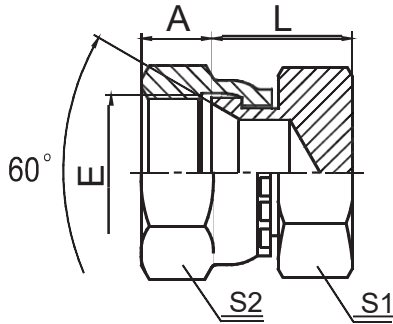



9K

日本公制内螺纹60° 内锥堵头
JIS METRIC FEMALE 60° CONE PLUG

| 代号 PART NO. | 螺纹 THREAD | | | | 尺寸 DIMENSIONS | | | | |
|----------------|-----------|--|--|--|---------------|------|----|----|--|
| | E | | | | A | L | S1 | S2 | |
| 9K-14 | M14X1.5 | | | | 10.5 | 15 | 19 | 19 | |
| 9K-16 | M16X1.5 | | | | 10 | 17.5 | 22 | 22 | |
| 9K-18 | M18X1.5 | | | | 11.5 | 18.5 | 24 | 24 | |
| 9K-22 | M22X1.5 | | | | 14 | 21 | 27 | 27 | |
| 9K-24 | M24X1.5 | | | | 15 | 22.5 | 32 | 32 | |
| 9K-30 | M30X1.5 | | | | 18.3 | 25 | 36 | 36 | |
| 9K-33 | M33X1.5 | | | | 21.3 | 25.5 | 41 | 41 | |

日本公制螺纹60° 锥面密封接头 Japanese Metric Thread 60° Cone Fittings

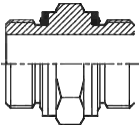
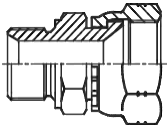
型号索引 Part NO. Index

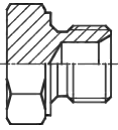
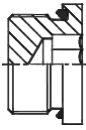
|  1H PD1 |  2MJ PD2 |  4H PD2 |  4M PD3 |  4MN-WD PD3 | |
|--|---|--|--|--|--|
| | | | | | |
| | | | | | |
| | | | | | |
| | | | | | |
| | | | | | |
| | | | | | |

D

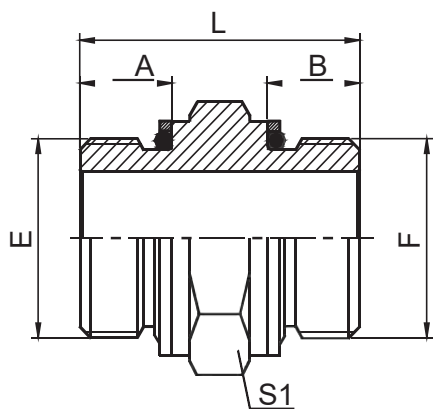

1H

公制外螺纹轻系列ISO 6149-3
METRIC MALE L-SERIES ISO 6149-3

| 代号 PART NO. | 螺纹 THREAD | | O形圈O-RING | | 尺寸 DIMENSIONS | | | | |
|----------------|-----------|---------|-----------|-----------|---------------|------|----|----|--|
| | E | F | E端 | F端 | A | B | L | S1 | |
| 1H-10 | M10X1 | M10X1 | O08.1X1.6 | O08.1X1.6 | 8.5 | 8.5 | 28 | 14 | |
| 1H-12 | M12X1.5 | M12X1.5 | O09.3X2.4 | O09.3X2.4 | 11.0 | 11.0 | 33 | 17 | |
| 1H-14 | M14X1.5 | M14X1.5 | O11.3X2.4 | O11.3X2.4 | 11.0 | 11.0 | 33 | 19 | |
| 1H-16 | M16X1.5 | M16X1.5 | O13.3X2.4 | O13.3X2.4 | 11.5 | 11.5 | 34 | 22 | |
| 1H-18 | M18X1.5 | M18X1.5 | O15.3X2.4 | O15.3X2.4 | 12.5 | 12.5 | 36 | 24 | |
| 1H-22 | M22X1.5 | M22X1.5 | O19.3X2.4 | O19.3X2.4 | 13.0 | 13.0 | 41 | 27 | |
| 1H-27 | M27X2 | M27X2 | O23.5X3.0 | O23.5X3.0 | 16.0 | 16.0 | 46 | 32 | |
| 1H-33 | M33X2 | M33X2 | O29.5X3.0 | O29.5X3.0 | 14.0 | 14.0 | 44 | 41 | |
| 1H-42 | M42X2 | M42X2 | O38.5X3.0 | O38.5X3.0 | 16.0 | 16.0 | 51 | 50 | |
| 1H-48 | M48X2 | M48X2 | O44.5X3.0 | O44.5X3.0 | 17.5 | 17.5 | 52 | 55 | |

注：可与ISO 9974-1油口相配，去掉挡圈与ISO 6149-1油口相配。

Note: fit for ISO 9974-1 port or ISO 6149-1 port when useless of retaining ring.

其它公制螺纹接头 Other Metric Thread Fittings

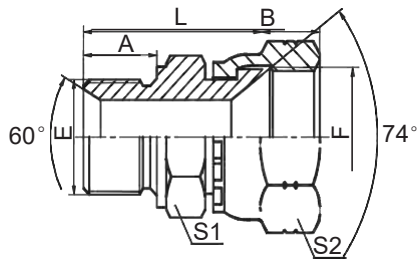

2MJ

公制外螺纹60° 内锥 / JIC内螺纹74° 内锥
 METRIC MALE 60° SEAT / JIC FEMALE 74° SEAT

| 代号 PART NO. | 螺纹 THREAD | | 尺寸 DIMENSIONS | | | | |
|----------------|-----------|------------|---------------|------|------|----|----|
| | E | F | A | B | L | S | S2 |
| 2MJ-10-04 | M10X1 | 7/16"X20 | 8 | 9 | 22 | 14 | 17 |
| 2MJ-12-05 | M12X1.5 | 1/2"X20 | 10 | 9.5 | 24.5 | 17 | 17 |
| 2MJ-14-06 | M14X1.5 | 9/16"X18 | 11 | 10.5 | 25.5 | 19 | 19 |
| 2MJ-16-08 | M16X1.5 | 3/4"X16 | 12 | 10.5 | 30.5 | 22 | 24 |
| 2MJ-18-08 | M18X1.5 | 3/4"X16 | 12 | 10.5 | 30.5 | 24 | 24 |
| 2MJ-18-10 | M18X1.5 | 7/8"X14 | 12 | 12 | 3 | 24 | 27 |
| 2MJ-22-10 | M22X1.5 | 7/8"X14 | 14 | 12 | 35 | 27 | 27 |
| 2MJ-27-12 | M27X2 | 1.1/16"X12 | 16 | 15 | 40.5 | 32 | 32 |
| 2MJ-27D-12 | M27X1.5 | 1.1/16"X12 | 16 | 15 | 39.5 | 32 | 32 |
| 2MJ-30-16 | M30X2 | 1.5/16"X12 | 18 | 16 | 42.5 | 36 | 4 |
| 2MJ-30D-16 | M30X1.5 | 1.5/16"X12 | 18 | 16 | 41.5 | 36 | 41 |
| 2MJ-45-20 | M45X2 | 1.5/8"X12 | 20 | 17 | 49 | 55 | 50 |
| 2MJ-45D-20 | M45X1.5 | 1.5/8"X12 | 20 | 17 | 49 | 55 | 50 |
| 2MJ-52-24 | M52X2 | 1.7/8"X12 | 20 | 20 | 49.5 | 60 | 55 |
| 2MJ-52D-24 | M52X1.5 | 1.7/8"X12 | 20 | 20 | 49.5 | 60 | 55 |

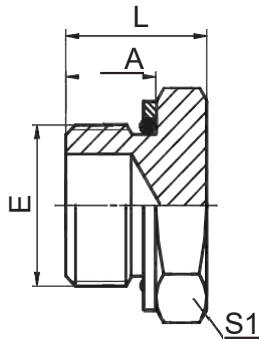

4H

公制外螺纹轻系列堵头ISO 6149-3
 METRIC MALE L-SERIES PLUG ISO 6149-3

| 代号 PART NO. | 螺纹 THREAD | | O形圈 O-RING | | 尺寸 DIMENSIONS | | | |
|----------------|-----------|--|------------|--|---------------|------|----|--|
| | E | | E端 | | A | L | S1 | |
| 4H-12 | M12X1.5 | | O09.3X2.4 | | 11 | 19 | 17 | |
| 4H-14 | M14X1.5 | | O11.3X2.4 | | 11 | 19 | 19 | |
| 4H-16 | M16X1.5 | | O13.3X2.4 | | 11.5 | 20 | 22 | |
| 4H-18 | M18X1.5 | | O15.3X2.4 | | 12.5 | 22 | 24 | |
| 4H-22 | M22X1.5 | | O19.3X2.4 | | 13 | 23.5 | 27 | |
| 4H-27 | M27X2 | | O23.5X3.0 | | 16 | 27.5 | 32 | |
| 4H-33 | M33X2 | | O29.5X3.0 | | 16 | 27 | 41 | |
| 4H-42 | M42X2 | | O38.5X3.0 | | 16 | 31 | 50 | |

注：可与ISO 9974-1油口相配，去掉挡圈与ISO 6149-1油口相配。
 Note: fit for ISO 9974-1 port or ISO 6149-1 port when useless of retaining ring.

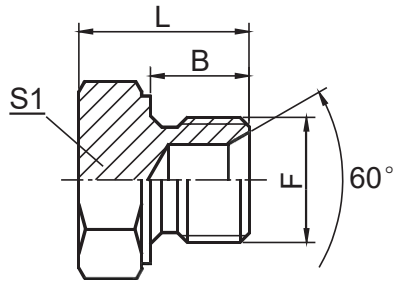

4M

公制外螺纹60° 内锥或六角端面用组合垫密封堵头

METRIC MALE DOUBLE USE FOR 60° CONE SEAT OR BONDED SEAL PLUG

D

| 代号 PART NO. | 螺 纹 THREAD | 尺 寸 DIMENSIONS | | | | | |
|----------------|---------------|-------------------|----|----|----|--|--|
| | | F | B | L | S1 | | |
| 4M-10 | M10X1 | | 8 | 15 | 14 | | |
| 4M-12 | M12X1.5 | | 10 | 17 | 17 | | |
| 4M-14 | M14X1.5 | | 11 | 19 | 19 | | |
| 4M-16 | M16X1.5 | | 12 | 20 | 22 | | |
| 4M-18 | M18X1.5 | | 12 | 20 | 24 | | |
| 4M-20 | M20X1.5 | | 14 | 23 | 27 | | |
| 4M-22 | M22X1.5 | | 14 | 23 | 27 | | |
| 4M-24 | M24X1.5 | | 14 | 25 | 30 | | |
| 4M-26 | M26X1.5 | | 16 | 28 | 32 | | |
| 4M-27D | M27X1.5 | | 16 | 28 | 32 | | |
| 4M-30 | M30X2 | | 18 | 30 | 36 | | |
| 4M-30D | M30X1.5 | | 18 | 30 | 36 | | |

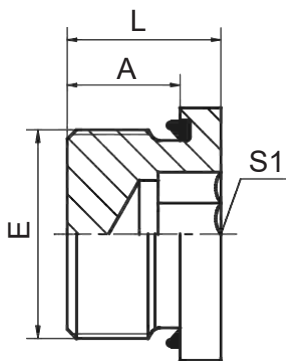

4MN-WD

公制外螺纹胶垫密封内六角堵头

METRIC MALE CAPTIVE SEAL HOLLOW HEX PLUG

| 代号 PART NO. | 螺 纹 THREAD | 胶 垫 CAPTIVE | 尺 寸 DIMENSIONS | | | | | |
|----------------|---------------|----------------|-------------------|----|------|----|--|--|
| | | | E | A | L | S1 | | |
| 4MN-10WD | M10X1 | WD-B02 | | 8 | 12 | 5 | | |
| 4MN-12WD | M12X1.5 | WD-M12 | | 12 | 17 | 6 | | |
| 4MN-14WD | M14X1.5 | WD-B04 | | 12 | 17 | 6 | | |
| 4MN-16WD | M16X1.5 | WD-M16 | | 12 | 17 | 8 | | |
| 4MN-18WD | M18X1.5 | WD-M18 | | 12 | 17 | 8 | | |
| 4MN-20WD | M20X1.5 | WD-M20 | | 14 | 19 | 10 | | |
| 4MN-22WD | M22X1.5 | WD-M22 | | 14 | 19 | 10 | | |
| 4MN-26WD | M26X1.5 | WD-B12 | | 16 | 21 | 12 | | |
| 4MN-27WD | M27X2 | WD-B12 | | 16 | 21 | 12 | | |
| 4MN-33WD | M33X2 | WD-B16 | | 18 | 24.5 | 17 | | |
| 4MN-42WD | M42X2 | WD-B20 | | 20 | 26.5 | 22 | | |
| 4MN-48WD | M48X2 | WD-B24 | | 22 | 28.5 | 24 | | |

英制螺纹接头
British Thread Fittings

日本英管螺纹60° 锥面密封接头
Japanese BSP Thread 60° Cone Fittings

英管螺纹60° 锥面密封接头
BSP Thread 60° Cone Fittings

英锥管螺纹BSPT接头
BSPT Thread Fittings

E

F

G

型号索引 Part NO. Index

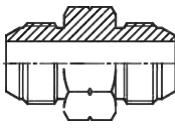
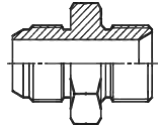
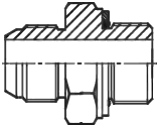
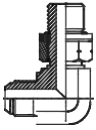
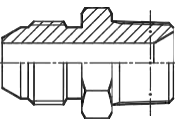
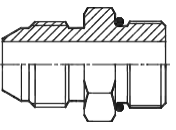
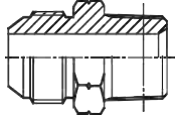
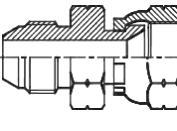
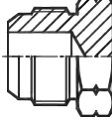
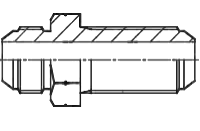
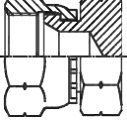
| | | | | | |
|---|--|--|--|--|--|
|  <p>1S PE1</p> |  <p>1SB PE1</p> |  <p>1SG PE2</p> |  <p>1SG9-OG PE2</p> |  <p>1SN PE3</p> |  <p>1SO PE3</p> |
|  <p>1ST-SP PE4</p> |  <p>2S PE5</p> |  <p>4S PE5</p> |  <p>6S PE6</p> |  <p>9S PE6</p> | |
| | | | | | |
| | | | | | |
| | | | | | |
| | | | | | |
| | | | | | |

日本英管螺纹60° 锥面密封接头 Japanese BSP Thread 60° Cone Fittings

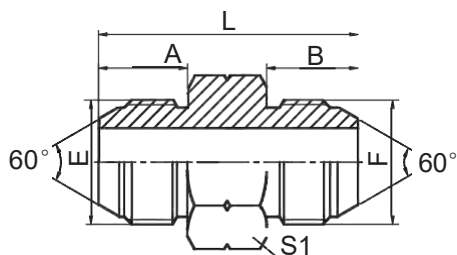

1S

日本英管外螺纹60° 外锥
JIS GAS MALE 60° CONE

| 代号 PART NO. | 螺纹 THREAD | | 尺寸 DIMENSIONS | | | | |
|----------------|--------------|------------|------------------|----|----|----|--|
| | E | F | A | B | L | S1 | |
| 1S-02 | G1/8"X28 | G1/8"X28 | 12 | 12 | 30 | 14 | |
| 1S-04 | G1/4"X19 | G1/4"X19 | 16 | 16 | 38 | 17 | |
| 1S-06 | G3/8"X19 | G3/8"X19 | 18 | 18 | 42 | 19 | |
| 1S-08 | G1/2"X14 | G1/2"X14 | 20 | 20 | 48 | 22 | |
| 1S-12 | G3/4"X14 | G3/4"X14 | 22 | 22 | 54 | 30 | |
| 1S-16 | G1"X11 | G1"X11 | 24 | 24 | 59 | 36 | |
| 1S-20 | G1.1/4"X11 | G1.1/4"X11 | 27 | 27 | 67 | 46 | |
| 1S-24 | G1.1/2"X11 | G1.1/2"X11 | 27 | 27 | 69 | 50 | |
| 1S-32 | G2"X11 | G2"X11 | 30 | 30 | 77 | 65 | |

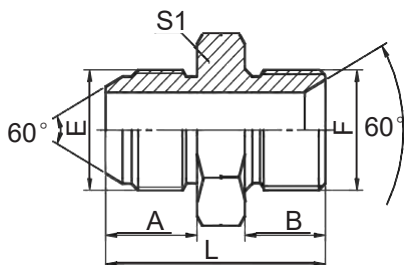

1SB

日式英管外螺纹
60° 外锥/英管外螺纹60° 内锥
JIS GAS MALE
60° CONE/BSP MALE 60° SEAT

| 代号 PART NO | 螺纹 THREAD | | 尺寸 DIMENSIONS | | | | |
|---------------|--------------|----------|------------------|------|------|----|--|
| | E | F | A | B | L | S1 | |
| 1SB-04 | G1/4"X19 | G1/4"X19 | 16 | 12 | 34 | 19 | |
| 1SB-04-06 | G1/4"X19 | G3/8"X19 | 16 | 13.5 | 37.5 | 22 | |
| 1SB-06 | G3/8"X19 | G3/8"X19 | 18 | 13.5 | 39.5 | 22 | |
| 1SB-06-04 | G3/8"X19 | G1/4"X19 | 18 | 12 | 36 | 19 | |
| 1SB-06-08 | G3/8"X19 | G1/2"X14 | 18 | 16 | 44 | 27 | |
| 1SB-08 | G1/2"X14 | G1/2"X14 | 20 | 16 | 46 | 27 | |
| 1SB-08-06 | G1/2"X14 | G3/8"X19 | 20 | 13.5 | 41.5 | 22 | |
| 1SB-08-12 | G1/2"X14 | G3/4"X14 | 20 | 18.5 | 49.5 | 32 | |
| 1SB-12 | G3/4"X14 | G3/4"X14 | 22 | 18.5 | 51.5 | 32 | |
| 1SB-12-06 | G3/4"X14 | G3/8"X19 | 22 | 13.5 | 45.5 | 30 | |
| 1SB-12-08 | G3/4"X14 | G1/2"X14 | 22 | 16 | 48 | 30 | |
| 1SB-12-16 | G3/4"X14 | G1"X11 | 22 | 20.5 | 55.5 | 41 | |
| 1SB-16 | G1"X11 | G1"X11 | 24 | 20.5 | 57.5 | 41 | |
| 1SB-16-08 | G1"X11 | G1/2"X14 | 24 | 16 | 51 | 36 | |
| 1SB-16-12 | G1"X11 | G3/4"X14 | 24 | 18.5 | 53.5 | 36 | |

日本英管螺纹60° 锥面密封接头 Japanese BSP Thread 60° Cone Fittings

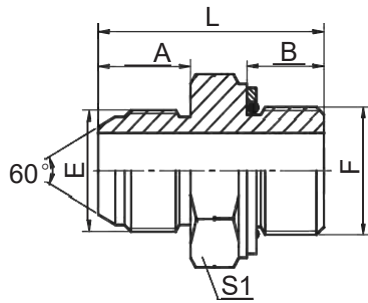

1SG

日本英管外螺纹60° 外锥 / 英管外螺纹O形圈
JIS GAS MALE 60° CONE / BSP MALE O-RING

| 代号 PART NO | 螺纹 THREAD | | O形圈 O-RING | 尺寸 DIMENSIONS | | | | | |
|---------------|------------|------------|------------|---------------|----|------|------|----|--|
| | E | F | F端 | A | B | L | S | | |
| 1SG-02 | G1/8"X28 | G1/8"X28 | | O011 | 12 | 8 | 27 | 14 | |
| 1SG-04 | G1/4"X19 | G1/4"X19 | | O11 | 16 | 1 | 34.5 | 19 | |
| 1SG-06 | G3/8"X19 | G3/8"X19 | | O113 | 18 | 11.5 | 37.5 | 24 | |
| 1SG-08 | G1/2"X14 | G1/2"X14 | | O115 | 20 | 14 | 44 | 27 | |
| 1SG-12 | G3/4"X14 | G3/4"X14 | | O119 | 22 | 15.5 | 48 | 36 | |
| 1SG-16 | G1"X1 | G1"X1 | | O217 | 24 | 18 | 53.5 | 4 | |
| 1SG-20 | G1.1/4"X11 | G1.1/4"X11 | | O222 | 27 | 20 | 59 | 50 | |
| 1SG-24 | G1.1/2"X1 | G1.1/2"X1 | | O224 | 27 | 21.5 | 62.5 | 60 | |

注： F端与 DIN 3852 油口相配。 F end is connected with DIN 3852 port.

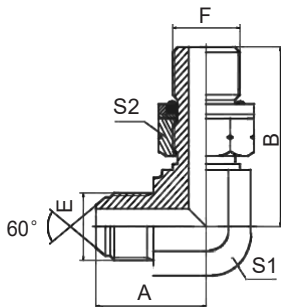

1SG9-OG

90° 弯日本英管外螺纹60° 外锥 / 英管外螺纹O形圈
90° ELBOW JIS GAS MALE 60° CONE / BSP MALE O-RING

| 代号 PART NO | 螺纹 THREAD | | O形圈 O-RING | 尺寸 DIMENSIONS | | | | | |
|---------------|------------|------------|------------|---------------|------|------|----|----|--|
| | E | F | F端 | A | B | S | S2 | | |
| 1SG9-02OG | G1/8"X28 | G1/8"X28 | | O011 | 21.8 | 25.5 | 11 | 14 | |
| 1SG9-04OG | G1/4"X19 | G1/4"X19 | | O11 | 28 | 31.3 | 14 | 19 | |
| 1SG9-06OG | G3/8"X19 | G3/8"X19 | | O113 | 29 | 35.8 | 16 | 22 | |
| 1SG9-08OG | G1/2"X14 | G1/2"X14 | | O115 | 38 | 43.2 | 22 | 27 | |
| 1SG9-12OG | G3/4"X14 | G3/4"X14 | | O119 | 43 | 49.3 | 27 | 32 | |
| 1SG9-16OG | G1"X1 | G1"X1 | | O217 | 48.5 | 53 | 33 | 4 | |
| 1SG9-20OG | G1.1/4"X11 | G1.1/4"X11 | | O222 | 57 | 59 | 41 | 50 | |
| 1SG9-24OG | G1.1/2"X1 | G1.1/2"X1 | | O224 | 6 | 65 | 48 | 55 | |

注： F端与 DIN 3852 油口相配。 F end is connected with DIN 3852 port.

日本英管螺纹60° 锥面密封接头 Japanese BSP Thread 60° Cone Fittings

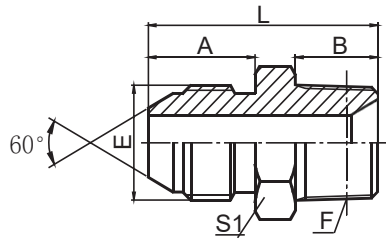

1SN

日本英管外螺纹60° 外锥 / 美制布锥管外螺纹
JIS GAS MALE 60° CONE / NPT MALE

| 代号 PART NO. | 螺纹 THREAD | | 尺寸 DIMENSIONS | | | | |
|----------------|------------|--------------|---------------|------|------|----|--|
| | E | F | A | B | L | S | |
| 1SN-04 | G1/4"X19 | Z1/4"X18 | 16 | 15 | 37 | 17 | |
| 1SN-04-02 | G1/4"X19 | Z1/8"X27 | 16 | 10.5 | 32.5 | 14 | |
| 1SN-06 | G3/8"X19 | Z3/8"X18 | 18 | 16 | 40 | 19 | |
| 1SN-06-04 | G3/8"X19 | Z1/4"X18 | 18 | 15 | 39 | 17 | |
| 1SN-08 | G1/2"X14 | Z1/2"X14 | 20 | 19.5 | 47.5 | 22 | |
| 1SN-08-06 | G1/2"X14 | Z3/8"X18 | 20 | 16 | 44 | 22 | |
| 1SN-12 | G3/4"X14 | Z3/4"X14 | 22 | 19.5 | 51.5 | 30 | |
| 1SN-12-08 | G3/4"X14 | Z1/2"X14 | 22 | 19.5 | 51.5 | 30 | |
| 1SN-16 | G1"X11 | Z1"X11.5 | 24 | 25.5 | 60.5 | 36 | |
| 1SN-16-12 | G1"X1 | Z3/4"X14 | 24 | 19.5 | 54.5 | 36 | |
| 1SN-20 | G1.1/4"X11 | Z1.1/4"X11.5 | 27 | 26.5 | 66.5 | 46 | |
| 1SN-20-16 | G1.1/4"X1 | Z1"X11.5 | 27 | 25.5 | 65.5 | 46 | |
| 1SN-24 | G1.1/2"X11 | Z1.1/2"X11.5 | 27 | 27.5 | 69.5 | 50 | |

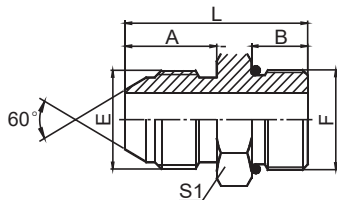

1SO

日式英管外螺纹 / 美制SAE外螺纹O形圈
90° JIS GAS MALE 60° CONE / NPT MALE

| 代号 PART NO. | 螺纹 THREAD | | O形圈O-RING F端 | 尺寸 DIMENSIONS | | | |
|----------------|------------|------------|-----------------|---------------|------|------|----|
| | E | F | | A | B | L | S |
| 1SO-04 | G1/4"X19 | 7/16"X20 | O904 | 16 | 9.1 | 31 | 14 |
| 1SO-04-06 | G1/4"X19 | 9/16"X18 | O906 | 16 | 9.9 | 32 | 17 |
| 1SO-06-04 | G3/8"X19 | 7/16"X20 | O904 | 18 | 9.1 | 33 | 17 |
| 1SO-06 | G3/8"X19 | 9/16"X18 | O906 | 18 | 9.9 | 34 | 17 |
| 1SO-08-06 | G1/2"X14 | 9/16"X18 | O906 | 20 | 9.9 | 40 | 22 |
| 1SO-08 | G1/2"X14 | 3/4"X16 | O908 | 20 | 11. | 39 | 22 |
| 1SO-12-10 | G3/4"X14 | 7/8"X14 | O910 | 22 | 12.7 | 44.5 | 30 |
| 1SO-12 | G3/4"X14 | 1.1/16"X12 | O912 | 22 | 15. | 48 | 32 |
| 1SO-16-12 | G1"X11 | 1.1/16"X12 | O912 | 24 | 15.1 | 50 | 36 |
| 1SO-16 | G1"X1 | 1.5/16"X12 | O916 | 24 | 15. | 50 | 38 |
| 1SO-20-16 | G1.1/4"X11 | 1.5/16"X12 | O916 | 27 | 15.1 | 59 | 46 |
| 1SO-20 | G1.1/4"X1 | 1.5/8"X12 | O920 | 27 | 15. | 6 | 50 |
| 1SO-24-20 | G1.1/2"X11 | 1.5/8"X12 | O920 | 27 | 15.1 | 57 | 50 |
| 1SO-24 | G1.1/2"X1 | 1.7/8"X12 | O924 | 27 | 15. | 6 | 55 |

日本英管螺纹60° 锥面密封接头 Japanese BSP Thread 60° Cone Fittings

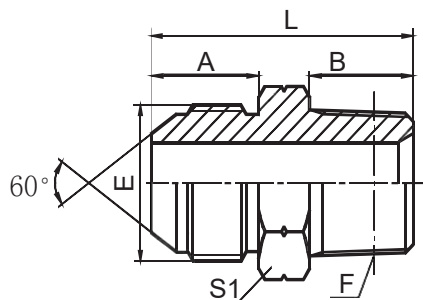

1ST-SP

日本英管外螺纹60° 外锥 / 英锥管外螺纹
JIS GAS MALE 60° CONE / BSPT MALE

| 代号 PART NO | 螺纹 THREAD | | 尺寸 DIMENSIONS | | | | | |
|---------------|------------|------------|---------------|------|------|----|--|--|
| | E | F | A | B | L | S | | |
| 1ST-02SP | G1/8"X28 | R1/8"X28 | 12 | 10 | 28 | 14 | | |
| 1ST-02-04SP | G1/8"X28 | R1/4"X19 | 12 | 14.5 | 32.5 | 14 | | |
| 1ST-04SP | G1/4"X19 | R1/4"X19 | 16 | 14.5 | 36.5 | 17 | | |
| 1ST-04-02SP | G1/4"X19 | R1/8"X28 | 16 | 10 | 32 | 17 | | |
| 1ST-04-06SP | G1/4"X19 | R3/8"X19 | 16 | 15 | 37 | 17 | | |
| 1ST-04-08SP | G1/4"X19 | R1/2"X14 | 16 | 20 | 44 | 22 | | |
| 1ST-06SP | G3/8"X19 | R3/8"X19 | 18 | 15 | 39 | 19 | | |
| 1ST-06-04SP | G3/8"X19 | R1/4"X19 | 18 | 14.5 | 40.5 | 22 | | |
| 1ST-06-08SP | G3/8"X19 | R1/2"X14 | 18 | 20 | 46 | 22 | | |
| 1ST-08SP | G1/2"X14 | R1/2"X14 | 20 | 20 | 48 | 22 | | |
| 1ST-08-04SP | G1/2"X14 | R1/4"X19 | 20 | 14.5 | 42.5 | 22 | | |
| 1ST-08-06SP | G1/2"X14 | R3/8"X19 | 20 | 15 | 45 | 27 | | |
| 1ST-08-12SP | G1/2"X14 | R3/4"X14 | 20 | 20 | 50 | 27 | | |
| 1ST-12SP | G3/4"X14 | R3/4"X14 | 22 | 20 | 53 | 30 | | |
| 1ST-12-08SP | G3/4"X14 | R1/2"X14 | 22 | 20 | 52 | 30 | | |
| 1ST-12-16SP | G3/4"X14 | R1"X1 | 22 | 25.5 | 58.5 | 36 | | |
| 1ST-16SP | G1"X11 | R1"X11 | 24 | 25.5 | 62 | 41 | | |
| 1ST-16-12SP | G1"X1 | R3/4"X14 | 24 | 20 | 57 | 4 | | |
| 1ST-20SP | G1.1/4"X11 | R1.1/4"X11 | 27 | 26.5 | 66 | 46 | | |
| 1ST-24SP | G1.1/2"X1 | R1.1/2"X1 | 27 | 26.5 | 67.5 | 50 | | |
| 1ST-32SP | G2"X11 | R2"X11 | 30 | 30 | 77 | 65 | | |

日本英管螺纹60° 锥面密封接头 Japanese BSP Thread 60° Cone Fittings

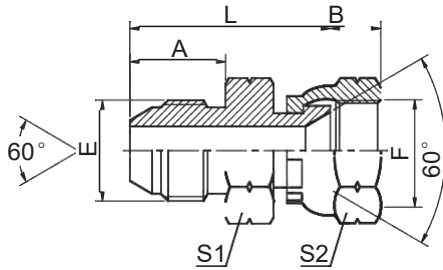

2S

日式英管外螺纹 / 日式英管内螺纹
JIS GAS MALE / JIS GAS FEMALE

| 代号 PART NO. | 螺纹 THREAD | | 尺寸 DIMENSIONS | | | | |
|----------------|------------|------------|---------------|------|----|----|------|
| | E | F | A | B | S1 | S2 | L |
| 2S-02 | G1/8"X28 | G1/8"X28 | 12 | 6.5 | 14 | 14 | 26 |
| 2S-04 | G1/4"X19 | G1/4"X19 | 16 | 8 | 17 | 19 | 30.5 |
| 2S-04-06 | G1/4"X19 | G3/8"X19 | 16 | 9 | 17 | 22 | 31.5 |
| 2S-06-04 | G3/8"X19 | G1/4"X19 | 18 | 8 | 19 | 19 | 33.5 |
| 2S-06 | G3/8"X19 | G3/8"X19 | 18 | 9 | 19 | 22 | 33.5 |
| 2S-06-08 | G3/8"X19 | G1/2"X14 | 18 | 12 | 19 | 27 | 35 |
| 2S-08-06 | G1/2"X14 | G3/8"X19 | 20 | 9 | 22 | 22 | 37.5 |
| 2S-08 | G1/2"X14 | G1/2"X14 | 20 | 12 | 22 | 27 | 39 |
| 2S-08-12 | G1/2"X14 | G3/4"X14 | 20 | 13.5 | 27 | 32 | 42.5 |
| 2S-12-08 | G3/4"X14 | G1/2"X14 | 22 | 12 | 30 | 27 | 43 |
| 2S-12 | G3/4"X14 | G3/4"X14 | 22 | 13.5 | 30 | 32 | 44.5 |
| 2S-12-16 | G3/4"X14 | G1"X11 | 22 | 16 | 32 | 41 | 47 |
| 2S-16-12 | G1"X11 | G3/4"X14 | 24 | 13.5 | 36 | 32 | 47.5 |
| 2S-16 | G1"X11 | G1"X11 | 24 | 16 | 36 | 41 | 49 |
| 2S-16-20 | G1"X11 | G1.1/4"X11 | 24 | 18.5 | 41 | 50 | 54 |
| 2S-20 | G1.1/4"X11 | G1.1/4"X11 | 27 | 18.5 | 46 | 50 | 54.5 |
| 2S-20-24 | G1.1/4"X11 | G1.1/2"X11 | 27 | 19 | 46 | 55 | 57.5 |
| 2S-24 | G1.1/2"X11 | G1.1/2"X11 | 27 | 19 | 50 | 55 | 59.5 |

E

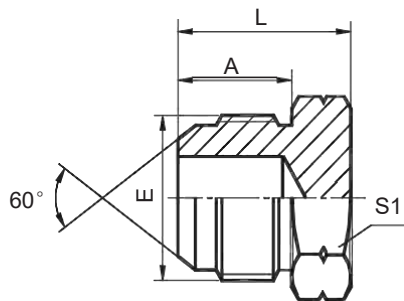

4S

日本英管外螺纹60°外锥
JIS GAS MALE 60° CONE

| 代号 PART NO. | 螺纹 THREAD | | 尺寸 DIMENSIONS | | | |
|----------------|------------|--|---------------|----|----|--|
| | E | | A | L | S1 | |
| 4S-02 | G1/8"X28 | | 12 | 18 | 14 | |
| 4S-04 | G1/4"X19 | | 16 | 24 | 17 | |
| 4S-06 | G3/8"X19 | | 18 | 24 | 19 | |
| 4S-08 | G1/2"X14 | | 20 | 28 | 22 | |
| 4S-12 | G3/4"X14 | | 22 | 33 | 30 | |
| 4S-16 | G1"X11 | | 24 | 35 | 36 | |
| 4S-20 | G1.1/4"X11 | | 27 | 40 | 46 | |
| 4S-24 | G1.1/2"X11 | | 27 | 42 | 50 | |
| 4S-32 | G2"X11 | | 30 | 47 | 65 | |

日本英管螺纹60° 锥面密封接头 Japanese BSP Thread 60° Cone Fittings

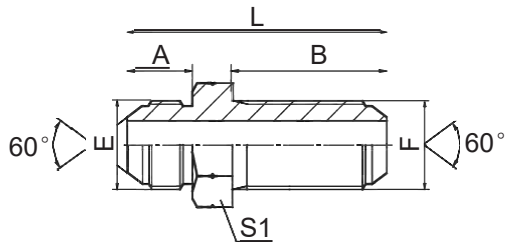

6S

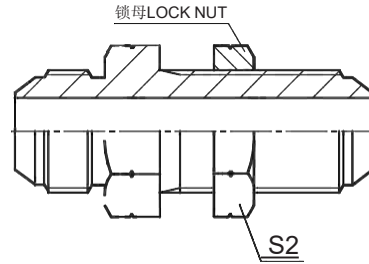

6S-LN

日本英管外螺纹60° 外锥过板接头
JIS GAS MALE 60° CONE BULKHEAD

| 代号 PART NO. | 螺纹 THREAD | | 尺寸 DIMENSIONS | | | | |
|----------------|-----------|----------|---------------|----|----|----|----|
| | E | F | A | B | L | S1 | S2 |
| 6S-04 | G1/4"X19 | G1/4"X19 | 16 | 32 | 56 | 19 | 19 |
| 6S-06 | G3/8"X19 | G3/8"X19 | 18 | 36 | 62 | 22 | 22 |
| 6S-08 | G1/2"X14 | G1/2"X14 | 20 | 40 | 70 | 27 | 27 |
| 6S-12 | G3/4"X14 | G3/4"X14 | 22 | 41 | 74 | 32 | 32 |
| 6S-16 | G1"X11 | G1"X11 | 24 | 45 | 88 | 41 | 41 |

注：如需带锁母整套订货，则请在代号后加“LN”，如6S-16LN，锁母代号为8B。

Note: In case if you are interested to order the adapter in complete set with lock nut, it is necessary to insert suffix "LN" after our part no., for example 6S-16LN, The lock nut no. is 8B.

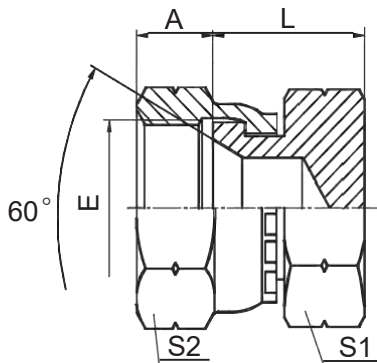

9S

日本英管内螺纹60° 内锥堵头
JIS GAS FEMALE 60° SEAT PLUG

| 代号 PART NO | 螺纹 THREAD | | 尺寸 DIMENSIONS | | | |
|---------------|------------|--|---------------|------|----|----|
| | E | | A | L | S | S2 |
| 9S-04 | G1/4"X19 | | 8 | 14.5 | 17 | 19 |
| 9S-06 | G3/8"X19 | | 9 | 15.5 | 19 | 22 |
| 9S-08 | G1/2"X14 | | 12 | 19 | 22 | 27 |
| 9S-12 | G3/4"X14 | | 13.5 | 23.5 | 32 | 32 |
| 9S-16 | G1"X11 | | 16 | 25 | 36 | 41 |
| 9S-20 | G1.1/4"X1 | | 18.5 | 30 | 50 | 50 |
| 9S-24 | G1.1/2"X11 | | 19 | 29.5 | 55 | 55 |
| 9S-32 | G2"X1 | | 23 | 32 | 70 | 70 |

英管螺纹60°锥面密封接头 BSP Thread 60° Cone Fittings

型号索引 Part NO. Index

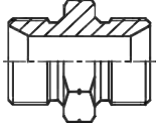
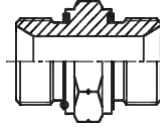
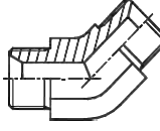
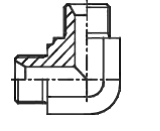
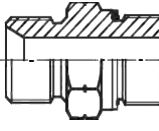
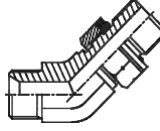
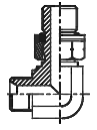
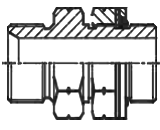
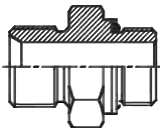
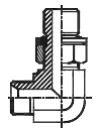
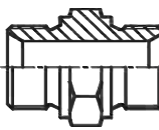
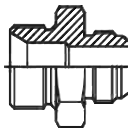
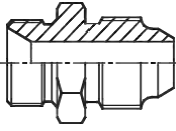
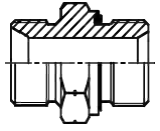
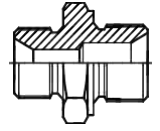
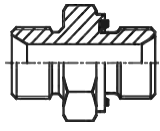
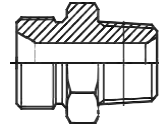
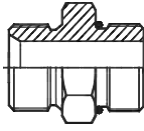
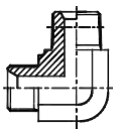
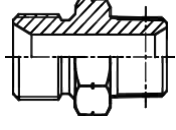
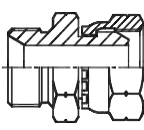
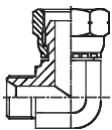
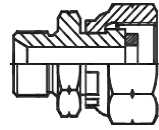
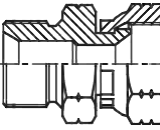
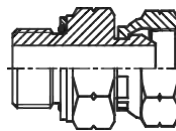
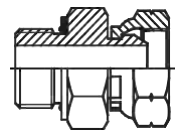
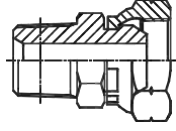
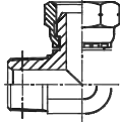
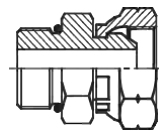
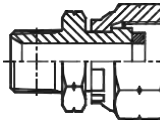
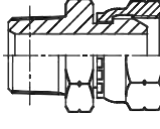
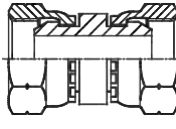
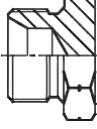
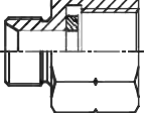
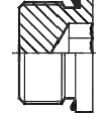
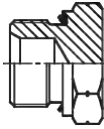
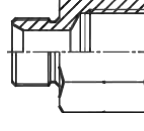
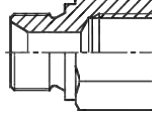
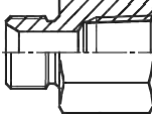
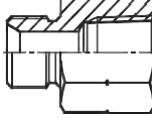
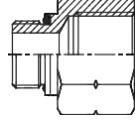
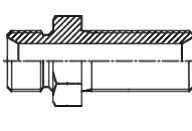
| | | | | | |
|--|---|--|--|---|---|
|  1B PF1 |  1B-2WD PF2 |  1B4 PF3 |  1B9 PF4 |  1BG PF5 |  1BG4-OG PF5 |
|  1BG9-OG PF6 |  1BG-OG PF6 |  1BH PF7 |  1BH9-OG PF8 |  1B-HS PF9 |  1BJ PF10 |
|  1BK PF11 |  1B-WD PF11 |  1BM PF12 |  1BM-WD PF13 |  1BN PF14 |  1BO PF15 |
|  1BT9-SP PF16 |  1BT-SP PF17 |  2B PF18 |  2B9 PF19 |  2B-G PF19 |  2BJ PF20 |
|  2GB PF21 |  2HB PF22 |  2NB PF23 |  2TB9-SP PF24 |  2OB PF24 |  2TB-G/SP PF25 |
|  2TB-SP PF25 |  3B PF26 |  4B PF27 |  5B-G PF27 |  4BN-WD PF28 |  4B-WD PF28 |
|  5B PF29 |  5B-HS PF30 |  5BN PF31 |  5BT PF31 |  5GB PF32 |  6B PF32 |

F

英管螺纹60°锥面密封接头 BSP Thread 60° Cone Fittings

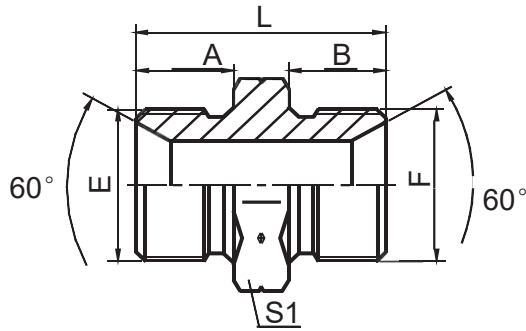

1B

英管外螺纹60°内锥或六角端面用组合垫密封
BSP MALE DOUBLE USE FOR 60° CONE
SEAT OR BONDED SEAL

F

| 代号 PART NO. | 螺 纹 THREAD | | 尺 寸 DIMENSIONS | | | |
|----------------|------------|------------|----------------|------|------|-----|
| | E | F | A | B | L | S1 |
| 1B-02 | G1/8"X28 | G1/8"X28 | 10 | 10 | 26 | 14 |
| 1B-02-04 | G1/8"X28 | G1/4"X19 | 10 | 12 | 28 | 19 |
| 1B-02-06 | G1/8"X28 | G3/8"X19 | 10 | 13.5 | 31.5 | 22 |
| 1B-02-08 | G1/8"X28 | G1/2"X14 | 10 | 16 | 36 | 27 |
| 1B-04 | G1/4"X19 | G1/4"X19 | 12 | 12 | 30 | 19 |
| 1B-04-06 | G1/4"X19 | G3/8"X19 | 12 | 13.5 | 33.5 | 22 |
| 1B-04-08 | G1/4"X19 | G1/2"X14 | 12 | 16 | 38 | 27 |
| 1B-04-10 | G1/4"X19 | G5/8"X14 | 12 | 17.5 | 39.5 | 30 |
| 1B-06 | G3/8"X19 | G3/8"X19 | 13.5 | 13.5 | 35 | 22 |
| 1B-06-08 | G3/8"X19 | G1/2"X14 | 13.5 | 16 | 39.5 | 27 |
| 1B-06-10 | G3/8"X19 | G5/8"X14 | 13.5 | 17.5 | 41 | 30 |
| 1B-06-12 | G3/8"X19 | G3/4"X14 | 13.5 | 18.5 | 43 | 32 |
| 1B-08 | G1/2"X14 | G1/2"X14 | 16 | 16 | 42 | 27 |
| 1B-08-10 | G1/2"X14 | G5/8"X14 | 16 | 17.5 | 43.5 | 30 |
| 1B-08-12 | G1/2"X14 | G3/4"X14 | 16 | 18.5 | 45.5 | 32 |
| 1B-10 | G5/8"X14 | G5/8"X14 | 17.5 | 17.5 | 45 | 30 |
| 1B-10-12 | G5/8"X14 | G3/4"X14 | 17.5 | 18.5 | 47 | 32 |
| 1B-10-16 | G5/8"X14 | G1"X11 | 17.5 | 20.5 | 51 | 41 |
| 1B-12 | G3/4"X14 | G3/4"X14 | 18.5 | 18.5 | 48 | 32 |
| 1B-12-16 | G3/4"X14 | G1"X11 | 18.5 | 20.5 | 52.5 | 41 |
| 1B-12-20 | G3/4"X14 | G1.1/4"X11 | 18.5 | 20.5 | 55 | 50 |
| 1B-16 | G1"X11 | G1"X11 | 20.5 | 20.5 | 54 | 41 |
| 1B-16-20 | G1"X11 | G1.1/4"X11 | 20.5 | 20.5 | 58 | 50 |
| 1B-16-24 | G1"X11 | G1.1/2"X11 | 20.5 | 23 | 60.5 | 55 |
| 1B-20 | G1.1/4"X11 | G1.1/4"X11 | 20.5 | 20.5 | 58 | 50 |
| 1B-20-24 | G1.1/4"X11 | G1.1/2"X11 | 20.5 | 23 | 60.5 | 55 |
| 1B-24 | G1.1/2"X11 | G1.1/2"X11 | 23 | 23 | 63 | 55 |
| 1B-24-32 | G1.1/2"X11 | G2"X11 | 23 | 25.5 | 66.5 | 70 |
| 1B-32 | G2"X11 | G2"X11 | 25.5 | 25.5 | 68 | 70 |
| 1B-40 | G2.1/2"X11 | G2.1/2"X11 | 32 | 32 | 81 | 90 |
| 1B-48 | G3"X11 | G3"X11 | 36 | 36 | 92 | 100 |

英管螺纹60°锥面密封接头 BSP Thread 60° Cone Fittings

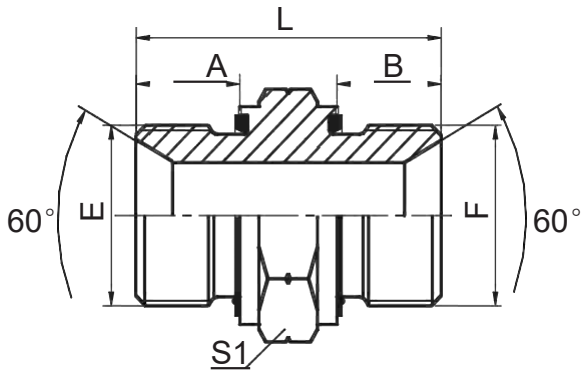

1B-2WD

英管外螺纹60° 内锥胶垫密封
BSP MALE 60° SEAT CAPTIVE SEAL

| 代号 PART NO. | 螺纹 THREAD | | 胶垫 CAPTIVE | | 尺寸 DIMENSIONS | | | |
|----------------|------------|------------|------------|--------|---------------|----|------|----|
| | E | F | E端 | F端 | A | B | L | S1 |
| 1B-02/2WD | G1/8"X28 | G1/8"X28 | WD-B02 | WD-B02 | 8 | 8 | 25 | 14 |
| 1B-02-04/2WD | G1/8"X28 | G1/4"X19 | WD-B02 | WD-B04 | 8 | 12 | 29.5 | 19 |
| 1B-04/2WD | G1/4"X19 | G1/4"X19 | WD-B04 | WD-B04 | 12 | 12 | 34 | 19 |
| 1B-04-06/2WD | G1/4"X19 | G3/8"X19 | WD-B04 | WD-B06 | 12 | 12 | 36.5 | 22 |
| 1B-06/2WD | G3/8"X19 | G3/8"X19 | WD-B06 | WD-B06 | 12 | 12 | 37 | 22 |
| 1B-06-08/2WD | G3/8"X19 | G1/2"X14 | WD-B06 | WD-B08 | 12 | 14 | 41.5 | 27 |
| 1B-08/2WD | G1/2"X14 | G1/2"X14 | WD-B08 | WD-B08 | 14 | 14 | 44 | 27 |
| 1B-08-12/2WD | G1/2"X14 | G3/4"X14 | WD-B08 | WD-B12 | 14 | 16 | 46 | 32 |
| 1B-12/2WD | G3/4"X14 | G3/4"X14 | WD-B12 | WD-B12 | 16 | 16 | 47 | 32 |
| 1B-12-16/2WD | G3/4"X14 | G1"X11 | WD-B12 | WD-B16 | 16 | 18 | 52 | 41 |
| 1B-16/2WD | G1"X11 | G1"X11 | WD-B16 | WD-B16 | 18 | 18 | 55 | 41 |
| 1B-16-20/2WD | G1"X11 | G1.1/4"X11 | WD-B16 | WD-B20 | 18 | 20 | 57 | 50 |
| 1B-20/2WD | G1.1/4"X11 | G1.1/4"X11 | WD-B20 | WD-B20 | 20 | 20 | 61 | 50 |
| 1B-20-24/2WD | G1.1/4"X11 | G1.1/2"X11 | WD-B20 | WD-B24 | 20 | 22 | 63 | 55 |
| 1B-24/2WD | G1.1/2"X11 | G1.1/2"X11 | WD-B24 | WD-B24 | 22 | 22 | 65 | 55 |
| 1B-24-32/2WD | G1.1/2"X11 | G2"X11 | WD-B24 | WD-B32 | 22 | 20 | 66 | 75 |
| 1B-32/2WD | G2"X11 | G2"X11 | WD-B32 | WD-B32 | 20 | 20 | 65 | 75 |

英管螺纹60°锥面密封接头 BSP Thread 60° Cone Fittings

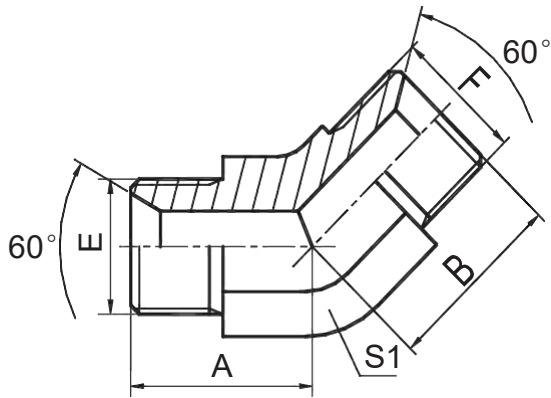

1B4

45° 英管外螺纹60° 内锥
45° BSP MALE 60° SEAT

F

| 代号 PART NO. | 螺纹 THREAD | | 尺寸 DIMENSIONS | | | |
|----------------|------------|------------|---------------|------|----|--|
| | E | F | A | B | S1 | |
| 1B4-02 | G1/8"X28 | G1/8"X28 | 17 | 17 | 11 | |
| 1B4-04 | G1/4"X19 | G1/4"X19 | 20.3 | 20.3 | 14 | |
| 1B4-04-06 | G1/4"X19 | G3/8"X19 | 20.5 | 22 | 16 | |
| 1B4-06 | G3/8"X19 | G3/8"X19 | 22 | 22 | 16 | |
| 1B4-06-08 | G3/8"X19 | G1/2"X14 | 24 | 27 | 22 | |
| 1B4-08 | G1/2"X14 | G1/2"X14 | 27 | 27 | 22 | |
| 1B4-08-12 | G1/2"X14 | G3/4"X14 | 28.5 | 31 | 27 | |
| 1B4-10 | G5/8"X14 | G5/8"X14 | 28.5 | 28.5 | 22 | |
| 1B4-10-12 | G5/8"X14 | G3/4"X14 | 30 | 31 | 27 | |
| 1B4-12 | G3/4"X14 | G3/4"X14 | 31 | 31 | 27 | |
| 1B4-12-16 | G3/4"X14 | G1"X11 | 32.5 | 35 | 33 | |
| 1B4-16 | G1"X11 | G1"X11 | 35 | 35 | 33 | |
| 1B4-16-20 | G1"X11 | G1.1/4"X11 | 38.5 | 38.5 | 41 | |
| 1B4-20 | G1.1/4"X11 | G1.1/4"X11 | 38.5 | 38.5 | 41 | |
| 1B4-20-24 | G1.1/4"X11 | G1.1/2"X11 | 41.5 | 44 | 48 | |
| 1B4-24 | G1.1/2"X11 | G1.1/2"X11 | 44 | 44 | 48 | |
| 1B4-32 | G2"X11 | G2"X11 | 51 | 51 | 63 | |

英管螺纹60°锥面密封接头 BSP Thread 60° Cone Fittings

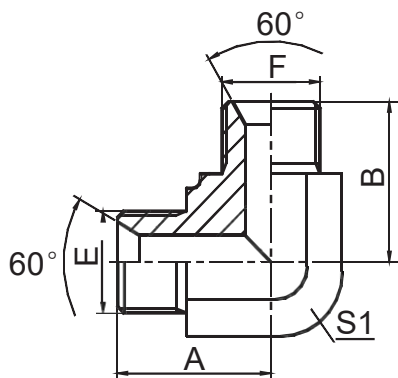

1B9

90° 弯英管外螺纹60° 内锥
90° ELBOW BSP MALE 60° SEAT

| 代号 PART NO. | 螺纹 THREAD | | 尺寸 DIMENSIONS | | | | | |
|----------------|------------|------------|---------------|------|----|--|--|--|
| | E | F | A | B | S1 | | | |
| 1B9-02 | G1/8"X28 | G1/8"X28 | 19.8 | 19.8 | 11 | | | |
| 1B9-02-04 | G1/8"X28 | G1/4"X19 | 23 | 25 | 14 | | | |
| 1B9-04 | G1/4"X19 | G1/4"X19 | 24.5 | 24.5 | 14 | | | |
| 1B9-04-06 | G1/4"X19 | G3/8"X19 | 26.5 | 27.5 | 16 | | | |
| 1B9-06 | G3/8"X19 | G3/8"X19 | 27.5 | 27.5 | 16 | | | |
| 1B9-06-08 | G3/8"X19 | G1/2"X14 | 31 | 34.5 | 22 | | | |
| 1B9-08 | G1/2"X14 | G1/2"X14 | 34.5 | 34.5 | 22 | | | |
| 1B9-08-12 | G1/2"X14 | G3/4"X14 | 37.5 | 40 | 27 | | | |
| 1B9-10 | G5/8"X14 | G5/8"X14 | 35 | 35 | 22 | | | |
| 1B9-10-12 | G5/8"X14 | G3/4"X14 | 38 | 39.5 | 27 | | | |
| 1B9-12 | G3/4"X14 | G3/4"X14 | 40 | 40 | 27 | | | |
| 1B9-12-16 | G3/4"X14 | G1"X11 | 43.5 | 46 | 33 | | | |
| 1B9-16 | G1"X11 | G1"X11 | 46 | 46 | 33 | | | |
| 1B9-16-20 | G1"X11 | G1.1/4"X11 | 50.5 | 50.5 | 41 | | | |
| 1B9-20 | G1.1/4"X11 | G1.1/4"X11 | 50.5 | 50.5 | 41 | | | |
| 1B9-20-24 | G1.1/4"X11 | G1.1/2"X11 | 54.5 | 57.5 | 48 | | | |
| 1B9-24 | G1.1/2"X11 | G1.1/2"X11 | 57.5 | 57.5 | 48 | | | |
| 1B9-32 | G2"X11 | G2"X11 | 68 | 68 | 63 | | | |

英管螺纹60°锥面密封接头 BSP Thread 60° Cone Fittings

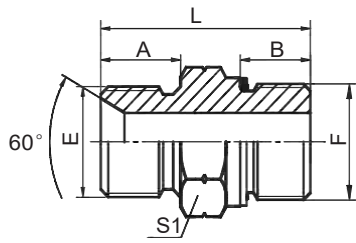

1BG

英管外螺纹60°内锥或六角端面用
组合垫密封 / 英管外螺纹O形圈
BSP MALE DOUBLE USE FOR 60° CONE
SEAT OR BONDED SEAL / BSP MALE O-RING

| 代号 PART NO. | 螺纹 THREAD | | O形圈 O-RING | | 尺寸 DIMENSIONS | | | | |
|----------------|------------|------------|------------|------|---------------|------|------|----|--|
| | E | F | | F端 | A | B | L | S1 | |
| 1BG-02 | G1/8"X28 | G1/8"X28 | | O011 | 10 | 8 | 25 | 14 | |
| 1BG-04 | G1/4"X19 | G1/4"X19 | | O111 | 12 | 11 | 30.5 | 19 | |
| 1BG-04-06 | G1/4"X19 | G3/8"X19 | | O113 | 12 | 11.5 | 32 | 24 | |
| 1BG-06 | G3/8"X19 | G3/8"X19 | | O113 | 13.5 | 11.5 | 34.5 | 24 | |
| 1BG-06-04 | G3/8"X19 | G1/4"X19 | | O111 | 13.5 | 11 | 32 | 22 | |
| 1BG-06-08 | G3/8"X19 | G1/2"X14 | | O115 | 13.5 | 14 | 39.5 | 27 | |
| 1BG-08 | G1/2"X14 | G1/2"X14 | | O115 | 16 | 14 | 39.5 | 27 | |
| 1BG-08-06 | G1/2"X14 | G3/8"X19 | | O113 | 16 | 11.5 | 39 | 27 | |
| 1BG-08-12 | G1/2"X14 | G3/4"X14 | | O119 | 16 | 15.5 | 44 | 36 | |
| 1BG-10-08 | G5/8"X14 | G1/2"X14 | | O115 | 17.5 | 14 | 43 | 30 | |
| 1BG-12 | G3/4"X14 | G3/4"X14 | | O119 | 18.5 | 15.5 | 45.5 | 36 | |
| 1BG-12-08 | G3/4"X14 | G1/2"X14 | | O115 | 18.5 | 14 | 44 | 32 | |
| 1BG-16-08 | G1"X11 | G1/2"X14 | | O115 | 20.5 | 14 | 49 | 41 | |
| 1BG-16 | G1"X11 | G1"X11 | | O217 | 20.5 | 18 | 53 | 41 | |
| 1BG-16-12 | G1"X11 | G3/4"X14 | | O119 | 20.5 | 15.5 | 50.5 | 41 | |
| 1BG-20 | G1.1/4"X11 | G1.1/4"X11 | | O222 | 20.5 | 20 | 58.5 | 50 | |
| 1BG-24 | G1.1/2"X11 | G1.1/2"X11 | | O224 | 23 | 21.5 | 61.5 | 60 | |

注： F端与DIN 3852油口相配。 F end is connected with DIN 3852 port.

F

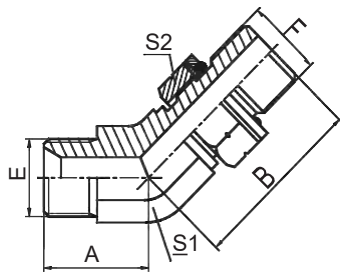

1BG4-OG

45°弯英管外螺纹
60°内锥 / 英管外螺纹O形圈
45° ELBOW BSP MALE
60° SEAT / BSP MALE O-RING

| 代号 PART NO. | 螺纹 THREAD | | O形圈 O-RING | | 尺寸 DIMENSIONS | | | | |
|----------------|------------|------------|------------|------|---------------|------|----|----|--|
| | E | F | | F端 | A | B | S1 | S2 | |
| 1BG4-04OG | G1/4"X19 | G1/4"X19 | | O111 | 22 | 28 | 14 | 19 | |
| 1BG4-04-06OG | G1/4"X19 | G3/8"X19 | | O113 | 21 | 30 | 16 | 22 | |
| 1BG4-04-08OG | G1/4"X19 | G1/2"X14 | | O115 | 22.5 | 36 | 22 | 27 | |
| 1BG4-06OG | G3/8"X19 | G3/8"X19 | | O113 | 21 | 30 | 16 | 22 | |
| 1BG4-06-08OG | G3/8"X19 | G1/2"X14 | | O115 | 23.5 | 36 | 22 | 27 | |
| 1BG4-08OG | G1/2"X14 | G1/2"X14 | | O115 | 27 | 36 | 22 | 27 | |
| 1BG4-12OG | G3/4"X14 | G3/4"X14 | | O119 | 32 | 42 | 27 | 32 | |
| 1BG4-12-16OG | G3/4"X14 | G1"X11 | | O217 | 32.5 | 44 | 33 | 41 | |
| 1BG4-16OG | G1"X11 | G1"X11 | | O217 | 34 | 44 | 33 | 41 | |
| 1BG4-20OG | G1.1/4"X11 | G1.1/4"X11 | | O222 | 38.5 | 47.5 | 41 | 50 | |
| 1BG4-24OG | G1.1/2"X11 | G1.1/2"X11 | | O224 | 44 | 51.5 | 48 | 55 | |

注： F端与DIN 3852油口相配。

英管螺纹60°锥面密封接头 BSP Thread 60° Cone Fittings

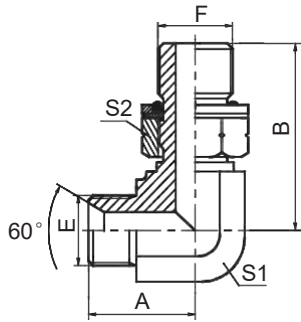

1BG9-OG

90° 弯英管外螺纹60° 内锥 / 英管外螺纹O形圈
 90° ELBOW BSP MALE 60° SEAT / BSP MALE O-RING

| 代号 PART NO. | 螺纹 THREAD | | O形圈 O-RING | | 尺寸 DIMENSIONS | | | | |
|----------------|------------|------------|------------|------|---------------|------|----|----|--|
| | E | F | | F端 | A | B | S1 | S2 | |
| 1BG9-04OG | G1/4"X19 | G1/4"X19 | | O111 | 25 | 31.5 | 14 | 19 | |
| 1BG9-04-06OG | G1/4"X19 | G3/8"X19 | | O113 | 26.5 | 36.8 | 16 | 22 | |
| 1BG9-06OG | G3/8"X19 | G3/8"X19 | | O113 | 28 | 36.8 | 16 | 22 | |
| 1BG9-06-08OG | G3/8"X19 | G1/2"X14 | | O115 | 31 | 43.2 | 22 | 27 | |
| 1BG9-08OG | G1/2"X14 | G1/2"X14 | | O115 | 34.5 | 43.2 | 22 | 27 | |
| 1BG9-08-12OG | G1/2"X14 | G3/4"X14 | | O119 | 40 | 49.3 | 27 | 32 | |
| 1BG9-12OG | G3/4"X14 | G3/4"X14 | | O119 | 40 | 49.3 | 27 | 32 | |
| 1BG9-12-16OG | G3/4"X14 | G1"X11 | | O217 | 45 | 53 | 33 | 41 | |
| 1BG9-16OG | G1"X11 | G1"X11 | | O217 | 46 | 53 | 33 | 41 | |
| 1BG9-20-16OG | G1.1/4"X11 | G1"X11 | | O217 | 50.5 | 58 | 41 | 41 | |
| 1BG9-20OG | G1.1/4"X11 | G1.1/4"X11 | | O222 | 51 | 59 | 41 | 50 | |
| 1BG9-24OG | G1.1/2"X11 | G1.1/2"X11 | | O224 | 58.5 | 63 | 48 | 55 | |

注：F端与DIN 3852油口相配。 Note: F end is connected with DIN 3852 port.

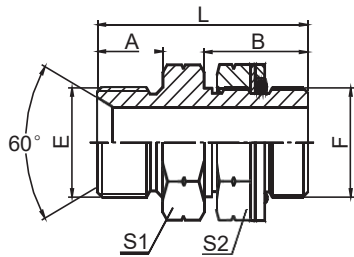

1BG-OG

英管外螺纹60° 内锥或六角端面用组合垫密封 /
 英管外螺纹O形圈
 BSP MALE DOUBLE USE FOR 60° CONE SEAT
 OR BONDED SEAL / BSP MALE O-RING

| 代号 PART NO. | 螺纹 THREAD | | O形圈 O-RING | | 尺寸 DIMENSIONS | | | | |
|----------------|------------|------------|------------|------|---------------|------|------|----|----|
| | E | F | | F端 | A | B | L | S1 | S2 |
| 1BG-04OG | G1/4"X19 | G1/4"X19 | | O111 | 12 | 21 | 39 | 19 | 19 |
| 1BG-04-06OG | G1/4"X19 | G3/8"X19 | | O113 | 12 | 24 | 42 | 19 | 22 |
| 1BG-06-04OG | G3/8"X19 | G1/4"X19 | | O111 | 13.5 | 21 | 42.5 | 22 | 19 |
| 1BG-06OG | G3/8"X19 | G3/8"X19 | | O113 | 13.5 | 24 | 45.5 | 22 | 22 |
| 1BG-06-08OG | G3/8"X19 | G1/2"X14 | | O115 | 13.5 | 28 | 49.5 | 22 | 27 |
| 1BG-08-06OG | G1/2"X14 | G3/8"X19 | | O113 | 16 | 24 | 50 | 27 | 22 |
| 1BG-08OG | G1/2"X14 | G1/2"X14 | | O115 | 16 | 28 | 54 | 27 | 27 |
| 1BG-12OG | G3/4"X14 | G3/4"X14 | | O119 | 18.5 | 32.5 | 62 | 32 | 32 |
| 1BG-16-08OG | G1"X11 | G1/2"X14 | | O115 | 20.5 | 28 | 61.5 | 41 | 27 |
| 1BG-16-12OG | G1"X11 | G3/4"X14 | | O119 | 20.5 | 32.5 | 66 | 41 | 32 |
| 1BG-16OG | G1"X11 | G1"X11 | | O217 | 20.5 | 32.5 | 66 | 41 | 41 |
| 1BG-20-08OG | G1.1/4"X11 | G1/2"X14 | | O115 | 20.5 | 28 | 63.5 | 50 | 27 |
| 1BG-20OG | G1.1/4"X11 | G1.1/4"X11 | | O222 | 20.5 | 33 | 68.5 | 50 | 50 |
| 1BG-24OG | G1.1/2"X11 | G1.1/2"X11 | | O224 | 23 | 34 | 72 | 55 | 55 |

注：F端与DIN 3852油口相配。 Note: F end is connected with DIN 3852 port.

英管螺纹60°锥面密封接头 BSP Thread 60° Cone Fittings

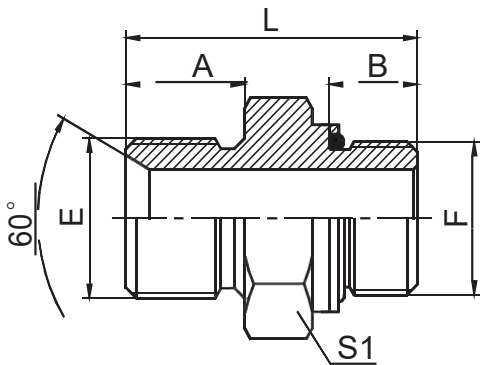

1BH

英管外螺纹60°内锥或六角端面用组合垫密封 /
公制外螺纹轻系列ISO 6149-3
BSP MALE DOUBLE USE FOR 60° CONE SEAT OR BONDED
SEAL / METRIC MALE L-SERIES ISO 6149-3

F

| 代号 PART NO. | 螺纹 THREAD | | O形圈 O-RING | | 尺寸 DIMENSIONS | | | | |
|----------------|------------|---------|------------|-----------|---------------|------|----|------|--|
| | E | F | | F端 | A | B | S1 | L | |
| 1BH-02-10 | G1/8"X28 | M10X1 | | O08.1X1.6 | 10 | 8.5 | 14 | 25 | |
| 1BH-02-12 | G1/8"X28 | M12X1.5 | | O09.3X2.4 | 10 | 11 | 17 | 29.5 | |
| 1BH-04-12 | G1/4"X19 | M12X1.5 | | O09.3X2.4 | 12 | 11 | 19 | 30 | |
| 1BH-04-14 | G1/4"X19 | M14X1.5 | | O11.3X2.4 | 12 | 11 | 19 | 31.5 | |
| 1BH-04-16 | G1/4"X19 | M16X1.5 | | O13.3X2.4 | 12 | 11.5 | 22 | 31.5 | |
| 1BH-06-14 | G3/8"X19 | M14X1.5 | | O11.3X2.4 | 13.5 | 11 | 22 | 35 | |
| 1BH-06-16 | G3/8"X19 | M16X1.5 | | O13.3X2.4 | 13.5 | 11.5 | 22 | 33 | |
| 1BH-06-18 | G3/8"X19 | M18X1.5 | | O15.3X2.4 | 13.5 | 12.5 | 24 | 36.5 | |
| 1BH-08-18 | G1/2"X14 | M18X1.5 | | O15.3X2.4 | 16 | 12.5 | 27 | 41 | |
| 1BH-08-22 | G1/2"X14 | M22X1.5 | | O19.3X2.4 | 16 | 13 | 27 | 41.5 | |
| 1BH-10-22 | G5/8"X14 | M22X1.5 | | O19.3X2.4 | 17.5 | 13 | 30 | 43 | |
| 1BH-12-16 | G3/4"X14 | M16X1.5 | | O13.3X2.4 | 18.5 | 11.5 | 32 | 43.5 | |
| 1BH-12-22 | G3/4"X14 | M22X1.5 | | O19.3X2.4 | 18.5 | 13 | 32 | 45 | |
| 1BH-12-27 | G3/4"X14 | M27X2 | | O23.5X3.0 | 18.5 | 16 | 32 | 45.5 | |
| 1BH-16-27 | G1"X11 | M27X2 | | O23.5X3.0 | 20.5 | 16 | 41 | 49 | |
| 1BH-16-33 | G1"X11 | M33X2 | | O29.5X3.0 | 20.5 | 16 | 41 | 52 | |
| 1BH-20-42 | G1.1/4"X11 | M42X2 | | O38.5X3.0 | 20.5 | 16 | 50 | 51.5 | |
| 1BH-24-48 | G1.1/2"X11 | M48X2 | | O44.5X3.0 | 23 | 17.5 | 55 | 55.5 | |

注：可与ISO 9974-1油口相配，去掉挡圈与ISO 6149-1油口相配。Note: fit for ISO 9974-1 port or ISO 6149-1 port when useless of retaining ring.

英管螺纹60°锥面密封接头 BSP Thread 60° Cone Fittings

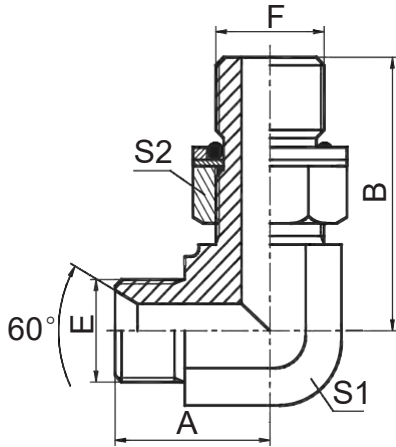

1BH9-OG

90° 弯英管外螺纹60° 内锥 / 公制
 外螺纹轻系列ISO 6149-3
 90° ELBOW BSP MALE 60° SEAT /
 METRIC MALE L-SERIES ISO 6149-3

| 代号 PART NO. | 螺纹 THREAD | | O形圈 O-RING | | 尺寸 DIMENSIONS | | | | |
|----------------|------------|---------|------------|-----------|---------------|------|----|----|--|
| | E | F | | F端 | A | B | S1 | S2 | |
| 1BH9-02-10OG | G1/8"X28 | M10X1 | | O08.1X1.6 | 20 | 26.5 | 11 | 14 | |
| 1BH9-02-12OG | G1/8"X28 | M12X1.5 | | O09.3X2.4 | 20 | 30.5 | 11 | 17 | |
| 1BH9-04-12OG | G1/4"X19 | M12X1.5 | | O09.3X2.4 | 24.5 | 32 | 14 | 17 | |
| 1BH9-04-14OG | G1/4"X19 | M14X1.5 | | O11.3X2.4 | 24.5 | 32.5 | 14 | 19 | |
| 1BH9-04-16OG | G1/4"X19 | M16X1.5 | | O13.3X2.4 | 26.5 | 34.8 | 16 | 22 | |
| 1BH9-06-14OG | G3/8"X19 | M14X1.5 | | O11.3X2.4 | 27.5 | 34 | 16 | 19 | |
| 1BH9-06-16OG | G3/8"X19 | M16X1.5 | | O13.3X2.4 | 27.5 | 34.8 | 16 | 22 | |
| 1BH9-06-18OG | G3/8"X19 | M18X1.5 | | O15.3X2.4 | 28.5 | 37 | 19 | 24 | |
| 1BH9-08-18OG | G1/2"X14 | M18X1.5 | | O15.3X2.4 | 34.5 | 39.5 | 22 | 24 | |
| 1BH9-08-22OG | G1/2"X14 | M22X1.5 | | O19.3X2.4 | 34.5 | 40.2 | 22 | 27 | |
| 1BH9-10-22OG | G5/8"X14 | M22X1.5 | | O19.3X2.4 | 35 | 40.2 | 22 | 27 | |
| 1BH9-12-22OG | G3/4"X14 | M22X1.5 | | O19.3X2.4 | 40 | 43.5 | 27 | 27 | |
| 1BH9-12-27OG | G3/4"X14 | M27X2 | | O23.5X3.0 | 40 | 48.5 | 27 | 32 | |
| 1BH9-16-27OG | G1"X11 | M27X2 | | O23.5X3.0 | 46 | 52 | 33 | 32 | |
| 1BH9-16-33OG | G1"X11 | M33X2 | | O29.5X3.0 | 46 | 52.5 | 33 | 41 | |
| 1BH9-20-42OG | G1.1/4"X11 | M42X2 | | O38.5X3.0 | 50.5 | 57.2 | 41 | 50 | |
| 1BH9-24-48OG | G1.1/2"X11 | M48X2 | | O44.5X3.0 | 57.5 | 62.5 | 48 | 55 | |

注：可与ISO 9974-1油口相配，去掉挡圈与ISO 6149-1油口相配。Note: fit for ISO 9974-1 port or ISO 6149-1 port when useless of retaining ring.

英管螺纹60°锥面密封接头 BSP Thread 60° Cone Fittings

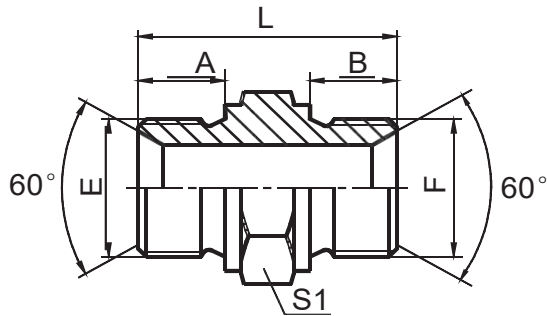

1B-HS

英管外螺纹
60°内锥或六角端面用组合垫密封
BSP MALE DOUBLE USE FOR 60° CONE
SEAT OR BONDED SEAL

F

| 代号 PART NO. | 螺纹 THREAD | | 尺寸 DIMENSIONS | | | |
|----------------|------------|------------|---------------|------|------|----|
| | E | F | A | B | L | S1 |
| 1B-02HS | G1/8"X28 | G1/8"X28 | 10.2 | 10.2 | 27.9 | 14 |
| 1B-02-04HS | G1/8"X28 | G1/4"X19 | 10.2 | 11 | 30.2 | 19 |
| 1B-02-06HS | G1/8"X28 | G3/8"X19 | 10.2 | 12.7 | 32.7 | 22 |
| 1B-02-08HS | G1/8"X28 | G1/2"X14 | 10.2 | 15.2 | 38.1 | 27 |
| 1B-04HS | G1/4"X19 | G1/4"X19 | 11 | 11 | 31.1 | 19 |
| 1B-04-06HS | G1/4"X19 | G3/8"X19 | 11 | 12.7 | 33.5 | 22 |
| 1B-04-08HS | G1/4"X19 | G1/2"X14 | 11 | 15.2 | 39.4 | 27 |
| 1B-04-12HS | G1/4"X19 | G3/4"X14 | 11 | 16 | 42.7 | 32 |
| 1B-06HS | G3/8"X19 | G3/8"X19 | 12.7 | 12.7 | 35.3 | 22 |
| 1B-06-08HS | G3/8"X19 | G1/2"X14 | 12.7 | 15.2 | 41.1 | 27 |
| 1B-06-10HS | G3/8"X19 | G5/8"X14 | 12.7 | 16 | 41.9 | 30 |
| 1B-06-12HS | G3/8"X19 | G3/4"X14 | 12.7 | 16 | 44.5 | 32 |
| 1B-06-16HS | G3/8"X19 | G1"X11 | 12.7 | 19.1 | 47.5 | 41 |
| 1B-08HS | G1/2"X14 | G1/2"X14 | 15.2 | 15.2 | 43.2 | 27 |
| 1B-08-10HS | G1/2"X14 | G5/8"X14 | 15.2 | 16 | 44.5 | 30 |
| 1B-08-12HS | G1/2"X14 | G3/4"X14 | 15.2 | 16 | 47 | 32 |
| 1B-08-16HS | G1/2"X14 | G1"X11 | 15.2 | 19.1 | 50.3 | 41 |
| 1B-10HS | G5/8"X14 | G5/8"X14 | 16 | 16 | 45.2 | 30 |
| 1B-10-12HS | G5/8"X14 | G3/4"X14 | 16 | 16 | 47.6 | 32 |
| 1B-12HS | G3/4"X14 | G3/4"X14 | 16 | 16 | 47.6 | 32 |
| 1B-12-16HS | G3/4"X14 | G1"X11 | 16 | 19.1 | 50.8 | 41 |
| 1B-12-20HS | G3/4"X14 | G1.1/4"X11 | 16 | 20.3 | 55 | 50 |
| 1B-16HS | G1"X11 | G1"X11 | 19.1 | 19.1 | 53.8 | 41 |
| 1B-16-20HS | G1"X11 | G1.1/4"X11 | 19.1 | 20.3 | 58.7 | 50 |
| 1B-16-24HS | G1"X11 | G1.1/2"X11 | 19.1 | 22.9 | 61.2 | 55 |
| 1B-16-32HS | G1"X11 | G2"X11 | 19.1 | 26 | 67 | 70 |
| 1B-20HS | G1.1/4"X11 | G1.1/4"X11 | 20.3 | 20.3 | 59 | 50 |
| 1B-20-24HS | G1.1/4"X11 | G1.1/2"X11 | 20.3 | 22.9 | 62.5 | 55 |
| 1B-20-32HS | G1.1/4"X11 | G2"X11 | 20.3 | 26 | 68.4 | 70 |
| 1B-24HS | G1.1/2"X11 | G1.1/2"X11 | 22.9 | 22.9 | 60 | 55 |
| 1B-24-32HS | G1.1/2"X11 | G2"X11 | 22.9 | 26 | 70.9 | 70 |
| 1B-32HS | G2"X11 | G2"X11 | 26 | 26 | 70.1 | 70 |

英管螺纹60°锥面密封接头 BSP Thread 60° Cone Fittings

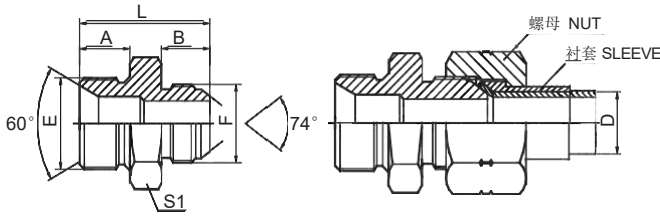

英管外螺纹60° 内锥或六角端面用
组合垫密封 / 美制JIC外螺纹74° 外锥
BSP MALE DOUBLE USE FOR 60° CONE SEAT
OR BONDED SEAL / JIC MALE 74° CONE

1BJ

| 代号 PART NO. | 螺纹 THREAD | | 尺寸 DIMENSIONS | | | | |
|----------------|------------|------------|---------------|------|------|-----|--|
| | E | F | A | B | L | S 1 | |
| 1BJ-02-04 | G1/8"X28 | 7/16"X20 | 10 | 14 | 30 | 14 | |
| 1BJ-02-05 | G1/8"X28 | 1/2"X20 | 10 | 14 | 30 | 14 | |
| 1BJ-02-06 | G1/8"X28 | 9/16"X18 | 10 | 14.1 | 30 | 17 | |
| 1BJ-04 | G1/4"X19 | 7/16"X20 | 12 | 14 | 32 | 19 | |
| 1BJ-04-05 | G1/4"X19 | 1/2"X20 | 12 | 14 | 32 | 19 | |
| 1BJ-04-06 | G1/4"X19 | 9/16"X18 | 12 | 14.1 | 32 | 19 | |
| 1BJ-04-08 | G1/4"X19 | 3/4"X16 | 12 | 16.7 | 36.5 | 22 | |
| 1BJ-04-10 | G1/4"X19 | 7/8"X14 | 12 | 19.3 | 39 | 24 | |
| 1BJ-06 | G3/8"X19 | 9/16"X18 | 13.5 | 14.1 | 35.5 | 22 | |
| 1BJ-06-04 | G3/8"X19 | 7/16"X20 | 13.5 | 14 | 35.5 | 22 | |
| 1BJ-06-05 | G3/8"X19 | 1/2"X20 | 13.5 | 14 | 35.5 | 22 | |
| 1BJ-06-08 | G3/8"X19 | 3/4"X16 | 13.5 | 16.7 | 38.5 | 22 | |
| 1BJ-06-10 | G3/8"X19 | 7/8"X14 | 13.5 | 19.3 | 41 | 24 | |
| 1BJ-06-12 | G3/8"X19 | 1.1/16"X12 | 13.5 | 21.9 | 45 | 30 | |
| 1BJ-08 | G1/2"X14 | 3/4"X16 | 16 | 16.7 | 43 | 27 | |
| 1BJ-08-04 | G1/2"X14 | 7/16"X20 | 16 | 14 | 40 | 27 | |
| 1BJ-08-05 | G1/2"X14 | 1/2"X20 | 16 | 14 | 40 | 27 | |
| 1BJ-08-06 | G1/2"X14 | 9/16"X18 | 16 | 14.1 | 40 | 27 | |
| 1BJ-08-10 | G1/2"X14 | 7/8"X14 | 16 | 19.3 | 45.5 | 27 | |
| 1BJ-08-12 | G1/2"X14 | 1.1/16"X12 | 16 | 21.9 | 48 | 30 | |
| 1BJ-08-14 | G1/2"X14 | 1.3/16"X12 | 16 | 22.6 | 49.5 | 32 | |
| 1BJ-08-16 | G1/2"X14 | 1.5/16"X12 | 16 | 23.1 | 50 | 36 | |
| 1BJ-10 | G5/8"X14 | 7/8"X14 | 17.5 | 19.3 | 47 | 30 | |
| 1BJ-10-08 | G5/8"X14 | 3/4"X16 | 17.5 | 16.7 | 44 | 30 | |
| 1BJ-10-12 | G5/8"X14 | 1.1/16"X12 | 17.5 | 21.9 | 49.5 | 30 | |
| 1BJ-10-16 | G5/8"X14 | 1.5/16"X12 | 17.5 | 23.1 | 51.5 | 36 | |
| 1BJ-12 | G3/4"X14 | 1.1/16"X12 | 18.5 | 21.9 | 51.5 | 32 | |
| 1BJ-12-06 | G3/4"X14 | 9/16"X18 | 18.5 | 14.1 | 43.5 | 32 | |
| 1BJ-12-08 | G3/4"X14 | 3/4"X16 | 18.5 | 16.7 | 46.5 | 32 | |
| 1BJ-12-10 | G3/4"X14 | 7/8"X14 | 18.5 | 19.3 | 49 | 32 | |
| 1BJ-12-14 | G3/4"X14 | 1.3/16"X12 | 18.5 | 22.6 | 52 | 32 | |
| 1BJ-12-16 | G3/4"X14 | 1.5/16"X12 | 18.5 | 23.1 | 52.5 | 34 | |
| 1BJ-12-20 | G3/4"X14 | 1.5/8"X12 | 18.5 | 24.3 | 55.5 | 46 | |
| 1BJ-16 | G1"X11 | 1.5/16"X12 | 20.5 | 23.1 | 56 | 41 | |
| 1BJ-16-08 | G1"X11 | 3/4"X16 | 20.5 | 16.7 | 50 | 41 | |
| 1BJ-16-10 | G1"X11 | 7/8"X14 | 20.5 | 19.3 | 53 | 41 | |
| 1BJ-16-12 | G1"X11 | 1.1/16"X12 | 20.5 | 21.9 | 55.5 | 41 | |
| 1BJ-16-14 | G1"X11 | 1.3/16"X12 | 20.5 | 22.6 | 56 | 41 | |
| 1BJ-16-20 | G1"X11 | 1.5/8"X12 | 20.5 | 24.3 | 58 | 46 | |
| 1BJ-20 | G1.1/4"X11 | 1.5/8"X12 | 20.5 | 24.3 | 62 | 50 | |
| 1BJ-20-12 | G1.1/4"X11 | 1.1/16"X12 | 20.5 | 21.9 | 57.5 | 50 | |
| 1BJ-20-16 | G1.1/4"X11 | 1.5/16"X12 | 20.5 | 23.1 | 60.5 | 50 | |
| 1BJ-20-24 | G1.1/4"X11 | 1.7/8"X12 | 20.5 | 27.5 | 63 | 50 | |
| 1BJ-24-16 | G1.1/2"X11 | 1.5/16"X12 | 23 | 23.1 | 61 | 55 | |
| 1BJ-24-20 | G1.1/2"X11 | 1.5/8"X12 | 23 | 24.3 | 62.5 | 55 | |
| 1BJ-24 | G1.1/2"X11 | 1.7/8"X12 | 23 | 27.5 | 67.5 | 55 | |
| 1BJ-24-32 | G1.1/2"X11 | 2.1/2"X12 | 23 | 33.9 | 74 | 65 | |
| 1BJ-32 | G2"X11 | 2.1/2"X12 | 25.5 | 33.9 | 77.5 | 70 | |
| 1BJ-32-24 | G2"X11 | 1.7/8"X12 | 25.5 | 27.5 | 70 | 70 | |

注：螺母及衬套需另行订货。管子直径D为公制时， 配用螺母及衬套分别选用NB200、NB500。管子直径为英制时， 配用螺母及衬套分别选用NB200、NB300。
Nut and sleeve should be ordered separately. The nut NB200 and sleeve NB500 is suitable for metric tube, the nut NB200 and sleeve NB300 is suitable for inch tube.

英管螺纹60°锥面密封接头 BSP Thread 60° Cone Fittings

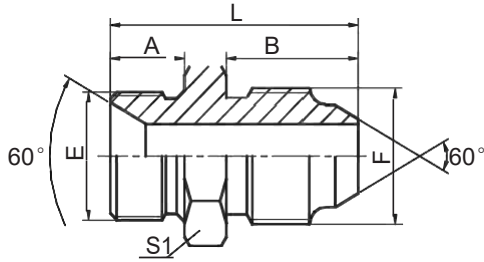

1BK

英管外螺纹
60° 内锥/日本公制外螺纹60° 外锥
BSP MALE 60° SEAT/JIS METRIC MALE 60° CONE

| 代号 PART NO. | 螺纹 THREAD | | 尺寸 DIMENSIONS | | | | | |
|----------------|------------|---------|---------------|--|------|------|------|----|
| | E | F | | | A | B | L | S1 |
| 1BK-04-14 | G1/4"X19 | M14X1.5 | | | 12 | 17 | 35 | 19 |
| 1BK-04-18 | G1/4"X19 | M18X1.5 | | | 12 | 18 | 38 | 22 |
| 1BK-06-18 | G3/8"X19 | M18X1.5 | | | 13.5 | 18 | 39.5 | 22 |
| 1BK-06-22 | G3/8"X19 | M22X1.5 | | | 13.5 | 20 | 41.5 | 24 |
| 1BK-08-18 | G1/2"X14 | M18X1.5 | | | 16 | 18 | 44 | 27 |
| 1BK-08-20 | G1/2"X14 | M20X1.5 | | | 16 | 20 | 46 | 27 |
| 1BK-08-22 | G1/2"X14 | M22X1.5 | | | 16 | 20 | 46 | 27 |
| 1BK-08-24 | G1/2"X14 | M24X1.5 | | | 16 | 21.5 | 45.5 | 27 |
| 1BK-10-24 | G5/8"X14 | M24X1.5 | | | 17.5 | 21.5 | 49 | 30 |
| 1BK-12-30 | G3/4"X14 | M30X1.5 | | | 18.5 | 26 | 55.5 | 32 |
| 1BK-16-33 | G1"X11 | M33X1.5 | | | 20.5 | 30 | 63.5 | 41 |
| 1BK-20-36 | G1.1/4"X11 | M36X1.5 | | | 20.5 | 33 | 68.5 | 50 |

F

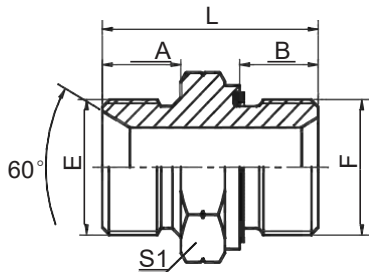

1B-WD

英管外螺纹60° 内锥或六角端面用
组合垫密封 / 英管外螺纹胶垫密封
BSP MALE DOUBLE USE FOR 60° CONE SEAT OR
BONDED SEAL / BSP MALE CAPTIVE SEAL

| 代号 PART NO. | 螺纹 THREAD | | 胶垫 CAPTIVE | | 尺寸 DIMENSIONS | | | |
|----------------|------------|------------|------------|--------|---------------|----|------|----|
| | E | F | | F端 | A | B | L | S1 |
| 1B-04WD | G1/4"X19 | G1/4"X19 | | WD-B04 | 12 | 12 | 32 | 19 |
| 1B-04-06WD | G1/4"X19 | G3/8"X19 | | WD-B06 | 12 | 12 | 34.5 | 22 |
| 1B-04-08WD | G1/4"X19 | G1/2"X14 | | WD-B08 | 12 | 14 | 39 | 27 |
| 1B-06WD | G3/8"X19 | G3/8"X19 | | WD-B06 | 13.5 | 12 | 34 | 22 |
| 1B-06-08WD | G3/8"X19 | G1/2"X14 | | WD-B08 | 13.5 | 14 | 40.5 | 27 |
| 1B-08WD | G1/2"X14 | G1/2"X14 | | WD-B08 | 16 | 14 | 43 | 27 |
| 1B-08-12WD | G1/2"X14 | G3/4"X14 | | WD-B12 | 16 | 16 | 46 | 32 |
| 1B-12WD | G3/4"X14 | G3/4"X14 | | WD-B12 | 18.5 | 16 | 46.5 | 32 |
| 1B-12-16WD | G3/4"X14 | G1"X11 | | WD-B16 | 18.5 | 18 | 52.5 | 41 |
| 1B-16WD | G1"X11 | G1"X11 | | WD-B16 | 20.5 | 18 | 54.5 | 41 |
| 1B-16-20WD | G1"X11 | G1.1/4"X11 | | WD-B20 | 20.5 | 20 | 58.5 | 50 |
| 1B-20WD | G1.1/4"X11 | G1.1/4"X11 | | WD-B20 | 20.5 | 20 | 58.5 | 50 |

英管螺纹60°锥面密封接头 BSP Thread 60° Cone Fittings

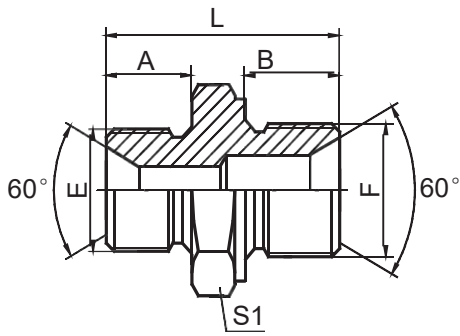

1BM

英管外螺纹60°内锥或六角端面用组合垫密封 /
 公制外螺纹60°内锥或六角端面用组合垫密封
 BSP MALE DOUBLE USE FOR 60°
 CONE SEAT OR BONDED SEAL /
 METRIC MALE DOUBLE USE FOR 60°
 CONE SEAT OR BONDED SEAL

| 代号 PART NO. | 螺 纹 THREAD | | 尺 寸 DIMENSIONS | | | | |
|----------------|------------|---------|----------------|----|------|----|--|
| | E | F | A | B | L | S1 | |
| 1BM-02-10 | G1/8"X28 | M10X1 | 10 | 8 | 25 | 14 | |
| 1BM-02-12 | G1/8"X28 | M12X1.5 | 10 | 10 | 27 | 17 | |
| 1BM-04-12 | G1/4"X19 | M12X1.5 | 12 | 10 | 29 | 19 | |
| 1BM-04-14 | G1/4"X19 | M14X1.5 | 12 | 11 | 30 | 19 | |
| 1BM-04-16 | G1/4"X19 | M16X1.5 | 12 | 12 | 33 | 22 | |
| 1BM-04-18 | G1/4"X19 | M18X1.5 | 12 | 12 | 33 | 24 | |
| 1BM-06-10 | G3/8"X19 | M10X1 | 13.5 | 8 | 29.5 | 22 | |
| 1BM-06-12 | G3/8"X19 | M12X1.5 | 13.5 | 10 | 31.5 | 22 | |
| 1BM-06-14 | G3/8"X19 | M14X1.5 | 13.5 | 11 | 32.5 | 22 | |
| 1BM-06-16 | G3/8"X19 | M16X1.5 | 13.5 | 12 | 33.5 | 22 | |
| 1BM-06-18 | G3/8"X19 | M18X1.5 | 13.5 | 12 | 34.5 | 24 | |
| 1BM-06-20 | G3/8"X19 | M20X1.5 | 13.5 | 14 | 38.5 | 27 | |
| 1BM-06-22 | G3/8"X19 | M22X1.5 | 13.5 | 14 | 38.5 | 27 | |
| 1BM-08-14 | G1/2"X14 | M14X1.5 | 16 | 11 | 38 | 27 | |
| 1BM-08-16 | G1/2"X14 | M16X1.5 | 16 | 12 | 39 | 27 | |
| 1BM-08-18 | G1/2"X14 | M18X1.5 | 16 | 12 | 39 | 27 | |
| 1BM-08-20 | G1/2"X14 | M20X1.5 | 16 | 14 | 41 | 27 | |
| 1BM-08-22 | G1/2"X14 | M22X1.5 | 16 | 14 | 41 | 27 | |
| 1BM-08-24 | G1/2"X14 | M24X1.5 | 16 | 14 | 41 | 30 | |
| 1BM-08-26 | G1/2"X14 | M26X1.5 | 16 | 16 | 44 | 32 | |
| 1BM-08-27D | G1/2"X14 | M27X1.5 | 16 | 16 | 44 | 32 | |
| 1BM-08-30 | G1/2"X14 | M30X1.5 | 16 | 18 | 45 | 36 | |
| 1BM-10-22 | G5/8"X14 | M22X1.5 | 17.5 | 14 | 42.5 | 30 | |
| 1BM-10-26 | G5/8"X14 | M26X1.5 | 17.5 | 16 | 45.5 | 32 | |
| 1BM-12-18 | G3/4"X14 | M18X1.5 | 18.5 | 12 | 42.5 | 32 | |
| 1BM-12-20 | G3/4"X14 | M20X1.5 | 18.5 | 14 | 44.5 | 32 | |
| 1BM-12-22 | G3/4"X14 | M22X1.5 | 18.5 | 14 | 44.5 | 32 | |
| 1BM-12-24 | G3/4"X14 | M24X1.5 | 18.5 | 14 | 44.5 | 32 | |
| 1BM-12-26 | G3/4"X14 | M26X1.5 | 18.5 | 16 | 46.5 | 32 | |
| 1BM-12-27 | G3/4"X14 | M27X2 | 18.5 | 16 | 46.5 | 32 | |
| 1BM-12-27D | G3/4"X14 | M27X1.5 | 18.5 | 16 | 46.5 | 32 | |
| 1BM-12-30 | G3/4"X14 | M30X2 | 18.5 | 18 | 47.5 | 36 | |
| 1BM-12-30D | G3/4"X14 | M30X1.5 | 18.5 | 18 | 47.5 | 36 | |
| 1BM-16-14 | G1"X11 | M14X1.5 | 20.5 | 11 | 45.5 | 41 | |
| 1BM-16-22 | G1"X11 | M22X1.5 | 20.5 | 14 | 48.5 | 41 | |
| 1BM-16-26 | G1"X11 | M26X1.5 | 20.5 | 16 | 50.5 | 41 | |
| 1BM-16-30 | G1"X11 | M30X2 | 20.5 | 18 | 53 | 41 | |
| 1BM-16-30D | G1"X11 | M30X1.5 | 20.5 | 18 | 53 | 41 | |

英管螺纹60°锥面密封接头 BSP Thread 60° Cone Fittings

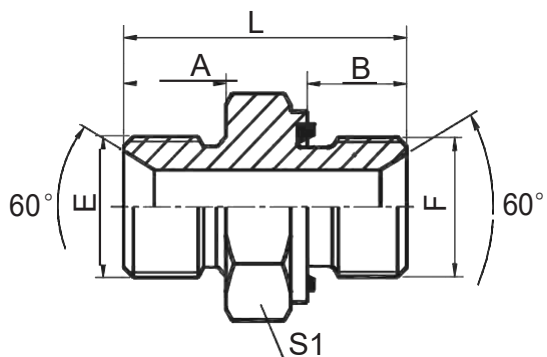

1BM-WD

英管外螺纹 / 公制外螺纹胶垫密封
BSP MALE / METRIC MALE CAPTIVE SEAL

F

| 代号 PART NO. | 螺纹 THREAD | | 胶垫 CAPTIVE | 尺寸 DIMENSIONS | | | | |
|----------------|-----------|---------|------------|---------------|------|----|------|----|
| | E | F | | F端 | A | B | L | S1 |
| 1BM-04-12WD | G1/4"X19 | M12X1.5 | | WD-M12 | 12 | 12 | 32 | 19 |
| 1BM-06-14WD | G3/8"X19 | M14X1.5 | | WD-B04 | 13.5 | 12 | 35.5 | 22 |
| 1BM-06-18WD | G3/8"X19 | M18X1.5 | | WD-M18 | 13.5 | 12 | 36 | 24 |
| 1BM-06-20WD | G3/8"X19 | M20X1.5 | | WD-M20 | 13.5 | 14 | 40 | 27 |
| 1BM-08-16WD | G1/2"X14 | M16X1.5 | | WD-M16 | 16 | 12 | 40 | 27 |
| 1BM-08-18WD | G1/2"X14 | M18X1.5 | | WD-M18 | 16 | 12 | 40.5 | 27 |
| 1BM-08-20WD | G1/2"X14 | M20X1.5 | | WD-M20 | 16 | 14 | 42.5 | 27 |
| 1BM-08-22WD | G1/2"X14 | M22X1.5 | | WD-M22 | 16 | 14 | 43 | 27 |
| 1BM-10-20WD | G5/8"X14 | M20X1.5 | | WD-M20 | 17.5 | 14 | 44.5 | 30 |
| 1BM-10-22WD | G5/8"X14 | M22X1.5 | | WD-M22 | 17.5 | 14 | 44.5 | 30 |
| 1BM-12-22WD | G3/4"X14 | M22X1.5 | | WD-M22 | 18.5 | 14 | 46.5 | 32 |

英管螺纹60°锥面密封接头 BSP Thread 60° Cone Fittings

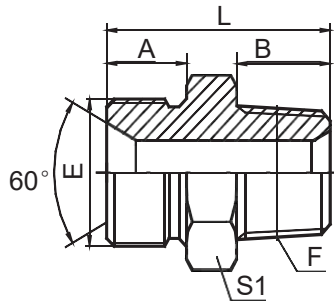

1BN

英管外螺纹60°内锥或六角端面用
组合垫密封/美制布锥管外螺纹
BSP MALE DOUBLE USE FOR 60°
CONE SEAT OR BONDED SEAL / NPT MALE

| 代号 PART NO. | 螺 纹 THREAD | | 尺 寸 DIMENSIONS | | | | | |
|----------------|------------|--------------|----------------|------|------|------|----|--|
| | E | F | | A | B | L | S1 | |
| 1BN-02 | G1/8"X28 | Z1/8"X27 | | 10 | 10.5 | 26 | 14 | |
| 1BN-02-04 | G1/8"X28 | Z1/4"X18 | | 10 | 15 | 31 | 17 | |
| 1BN-04 | G1/4"X19 | Z1/4"X18 | | 12 | 15 | 33 | 19 | |
| 1BN-04-02 | G1/4"X19 | Z1/8"X27 | | 12 | 10.5 | 28 | 19 | |
| 1BN-04-06 | G1/4"X19 | Z3/8"X18 | | 12 | 16 | 34 | 19 | |
| 1BN-04-08 | G1/4"X19 | Z1/2"X14 | | 12 | 19.5 | 39.5 | 22 | |
| 1BN-06 | G3/8"X19 | Z3/8"X18 | | 13.5 | 16 | 37.5 | 22 | |
| 1BN-06-04 | G3/8"X19 | Z1/4"X18 | | 13.5 | 15 | 36 | 22 | |
| 1BN-06-08 | G3/8"X19 | Z1/2"X14 | | 13.5 | 19.5 | 41 | 22 | |
| 1BN-06-12 | G3/8"X19 | Z3/4"X14 | | 13.5 | 19.5 | 43 | 30 | |
| 1BN-08 | G1/2"X14 | Z1/2"X14 | | 16 | 19.5 | 45.5 | 27 | |
| 1BN-08-06 | G1/2"X14 | Z3/8"X18 | | 16 | 16 | 42 | 27 | |
| 1BN-08-12 | G1/2"X14 | Z3/4"X14 | | 16 | 19.5 | 45.5 | 30 | |
| 1BN-08-16 | G1/2"X14 | Z1"X11.5 | | 16 | 25.5 | 52.5 | 36 | |
| 1BN-10-08 | G5/8"X14 | Z1/2"X14 | | 17.5 | 19.5 | 47 | 30 | |
| 1BN-10-12 | G5/8"X14 | Z3/4"X14 | | 17.5 | 19.5 | 47 | 30 | |
| 1BN-12 | G3/4"X14 | Z3/4"X14 | | 18.5 | 19.5 | 49 | 32 | |
| 1BN-12-06 | G3/4"X14 | Z3/8"X18 | | 18.5 | 16 | 45.5 | 32 | |
| 1BN-12-08 | G3/4"X14 | Z1/2"X14 | | 18.5 | 19.5 | 49 | 32 | |
| 1BN-12-16 | G3/4"X14 | Z1"X11.5 | | 18.5 | 25.5 | 55 | 36 | |
| 1BN-16 | G1"X11 | Z1"X11.5 | | 20.5 | 25.5 | 59 | 41 | |
| 1BN-16-12 | G1"X11 | Z3/4"X14 | | 20.5 | 19.5 | 53 | 41 | |
| 1BN-16-20 | G1"X11 | Z1.1/4"X11.5 | | 20.5 | 26.5 | 60 | 46 | |
| 1BN-20 | G1.1/4"X11 | Z1.1/4"X11.5 | | 20.5 | 26.5 | 62 | 50 | |
| 1BN-20-16 | G1.1/4"X11 | Z1"X11.5 | | 20.5 | 25.5 | 61 | 50 | |
| 1BN-20-24 | G1.1/4"X11 | Z1.1/2"X11.5 | | 20.5 | 27.5 | 63 | 50 | |
| 1BN-24 | G1.1/2"X11 | Z1.1/2"X11.5 | | 23 | 27.5 | 65.5 | 55 | |
| 1BN-24-20 | G1.1/2"X11 | Z1.1/4"X11.5 | | 23 | 26.5 | 64.5 | 55 | |
| 1BN-24-32 | G1.1/2"X11 | Z2"X11.5 | | 23 | 27.5 | 67.5 | 65 | |
| 1BN-32 | G2"X11 | Z2"X11.5 | | 25.5 | 27.5 | 70 | 70 | |
| 1BN-32-20 | G2"X11 | Z1.1/4"X11.5 | | 25.5 | 26.5 | 69 | 70 | |
| 1BN-32-24 | G2"X11 | Z1.1/2"X11.5 | | 25.5 | 27.5 | 70 | 70 | |

英管螺纹60°锥面密封接头 BSP Thread 60° Cone Fittings

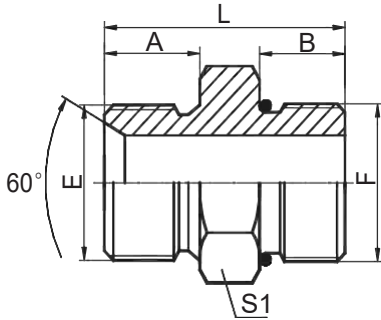

1BO

英管外螺纹60°内锥或六角端面用组合垫密封 /
 美制SAE外螺纹带O形圈轻系列ISO 11926-3
 BSP MALE DOUBLE USE FOR 60° CONE SEAT OR BONDED
 SEAL/SAE O-RING BOSS L-SERIES ISO 11926-3

F

| 代号 PART NO. | 螺纹 THREAD | | O形圈 O-RING | | 尺寸 DIMENSIONS | | | | |
|----------------|------------|------------|------------|------|---------------|------|------|----|--|
| | E | F | | F端 | A | B | L | S1 | |
| 1BO-04 | G1/4"X19 | 7/16"X20 | | O904 | 12 | 9.1 | 29.5 | 19 | |
| 1BO-04-05 | G1/4"X19 | 1/2"X20 | | O905 | 12 | 9.1 | 27 | 19 | |
| 1BO-04-06 | G1/4"X19 | 9/16"X18 | | O906 | 12 | 9.9 | 28 | 19 | |
| 1BO-04-08 | G1/4"X19 | 3/4"X16 | | O908 | 12 | 11.1 | 31 | 22 | |
| 1BO-06 | G3/8"X19 | 9/16"X18 | | O906 | 13.5 | 9.9 | 33.5 | 22 | |
| 1BO-06-04 | G3/8"X19 | 7/16"X20 | | O904 | 13.5 | 9.1 | 33 | 22 | |
| 1BO-06-08 | G3/8"X19 | 3/4"X16 | | O908 | 13.5 | 11.1 | 32.5 | 22 | |
| 1BO-06-10 | G3/8"X19 | 7/8"X14 | | O910 | 13.5 | 12.7 | 36 | 27 | |
| 1BO-08 | G1/2"X14 | 3/4"X16 | | O908 | 16 | 11.1 | 37 | 27 | |
| 1BO-08-06 | G1/2"X14 | 9/16"X18 | | O906 | 16 | 9.9 | 38 | 27 | |
| 1BO-08-10 | G1/2"X14 | 7/8"X14 | | O910 | 16 | 12.7 | 38.5 | 27 | |
| 1BO-08-12 | G1/2"X14 | 1.1/16"X12 | | O912 | 16 | 15.1 | 42 | 32 | |
| 1BO-10 | G5/8"X14 | 7/8"X14 | | O910 | 17.5 | 12.7 | 43 | 30 | |
| 1BO-10-08 | G5/8"X14 | 3/4"X16 | | O908 | 17.5 | 11.1 | 41.5 | 30 | |
| 1BO-10-12 | G5/8"X14 | 1.1/16"X12 | | O912 | 17.5 | 15.1 | 43.5 | 32 | |
| 1BO-12 | G3/4"X14 | 1.1/16"X12 | | O912 | 18.5 | 15.1 | 44.5 | 32 | |
| 1BO-12-08 | G3/4"X14 | 3/4"X16 | | O908 | 18.5 | 11.1 | 40.5 | 32 | |
| 1BO-12-10 | G3/4"X14 | 7/8"X14 | | O910 | 18.5 | 12.7 | 45.5 | 32 | |
| 1BO-12-14 | G3/4"X14 | 1.3/16"X12 | | O914 | 18.5 | 15.1 | 44.5 | 36 | |
| 1BO-12-16 | G3/4"X14 | 1.5/16"X12 | | O916 | 18.5 | 15.1 | 44.5 | 38 | |
| 1BO-16 | G1"X11 | 1.5/16"X12 | | O916 | 20.5 | 15.1 | 48 | 41 | |
| 1BO-16-10 | G1"X11 | 7/8"X14 | | O910 | 20.5 | 12.7 | 49.5 | 41 | |
| 1BO-16-12 | G1"X11 | 1.1/16"X12 | | O912 | 20.5 | 15.1 | 52 | 41 | |
| 1BO-16-14 | G1"X11 | 1.3/16"X12 | | O914 | 20.5 | 15.1 | 52 | 41 | |
| 1BO-16-20 | G1"X11 | 1.5/8"X12 | | O920 | 20.5 | 15.1 | 50.5 | 50 | |
| 1BO-20 | G1.1/4"X11 | 1.5/8"X12 | | O920 | 20.5 | 15.1 | 50.5 | 50 | |
| 1BO-20-16 | G1.1/4"X11 | 1.5/16"X12 | | O916 | 20.5 | 15.1 | 54.7 | 50 | |
| 1BO-24 | G1.1/2"X11 | 1.7/8"X12 | | O924 | 23 | 15.1 | 53 | 55 | |

英管螺纹60°锥面密封接头 BSP Thread 60° Cone Fittings

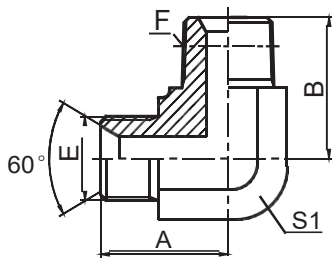

1BT9-SP

90° 弯英管外螺纹
60° 内锥 / 英锥管外螺纹
90° ELBOW BSP MALE
60° SEAT / BSPT MALE

| 代号 PART NO. | 螺 纹 THREAD | | 尺 寸 DIMENSIONS | | | | | |
|----------------|------------|------------|----------------|------|------|----|--|--|
| | E | F | | A | B | S1 | | |
| 1BT9-02SP | G1/8"X28 | R1/8"X28 | | 20 | 21 | 11 | | |
| 1BT9-02-04SP | G1/8"X28 | R1/4"X19 | | 22.3 | 25.5 | 14 | | |
| 1BT9-04SP | G1/4"X19 | R1/4"X19 | | 24.5 | 25.5 | 14 | | |
| 1BT9-04-02SP | G1/4"X19 | R1/8"X28 | | 25 | 23.5 | 14 | | |
| 1BT9-04-06SP | G1/4"X19 | R3/8"X19 | | 25 | 28.5 | 16 | | |
| 1BT9-04-08SP | G1/4"X19 | R1/2"X14 | | 30 | 36 | 22 | | |
| 1BT9-06SP | G3/8"X19 | R3/8"X19 | | 27.5 | 28.5 | 16 | | |
| 1BT9-06-04SP | G3/8"X19 | R1/4"X19 | | 27.5 | 26.5 | 16 | | |
| 1BT9-06-08SP | G3/8"X19 | R1/2"X14 | | 31 | 36 | 22 | | |
| 1BT9-08SP | G1/2"X14 | R1/2"X14 | | 34.5 | 36 | 22 | | |
| 1BT9-08-04SP | G1/2"X14 | R1/4"X19 | | 34.5 | 30.5 | 22 | | |
| 1BT9-08-06SP | G1/2"X14 | R3/8"X19 | | 34.5 | 32.5 | 22 | | |
| 1BT9-08-12SP | G1/2"X14 | R3/4"X14 | | 37.5 | 43.5 | 27 | | |
| 1BT9-08-16SP | G1/2"X14 | R1"X11 | | 41 | 50 | 33 | | |
| 1BT9-10-08SP | G5/8"X14 | R1/2"X14 | | 35 | 36 | 22 | | |
| 1BT9-10-12SP | G5/8"X14 | R3/4"X14 | | 39 | 43.5 | 27 | | |
| 1BT9-12SP | G3/4"X14 | R3/4"X14 | | 40 | 43 | 27 | | |
| 1BT9-12-06SP | G3/4"X14 | R3/8"X19 | | 40 | 36 | 27 | | |
| 1BT9-12-08SP | G3/4"X14 | R1/2"X14 | | 40 | 39.5 | 27 | | |
| 1BT9-12-16SP | G3/4"X14 | R1"X11 | | 43.5 | 50 | 33 | | |
| 1BT9-12-20SP | G3/4"X14 | R1.1/4"X11 | | 48 | 56.5 | 41 | | |
| 1BT9-16SP | G1"X11 | R1"X11 | | 46 | 50 | 33 | | |
| 1BT9-16-08SP | G1"X11 | R1/2"X14 | | 46 | 43 | 33 | | |
| 1BT9-16-12SP | G1"X11 | R3/4"X14 | | 46 | 47.5 | 33 | | |
| 1BT9-16-20SP | G1"X11 | R1.1/4"X11 | | 50.5 | 56.5 | 41 | | |
| 1BT9-20SP | G1.1/4"X11 | R1.1/4"X11 | | 52 | 59 | 41 | | |
| 1BT9-20-12SP | G1.1/4"X11 | R3/4"X14 | | 50.5 | 54 | 41 | | |
| 1BT9-20-16SP | G1.1/4"X11 | R1"X11 | | 52 | 56.5 | 41 | | |
| 1BT9-20-24SP | G1.1/4"X11 | R1.1/2"X11 | | 54.5 | 62.5 | 48 | | |
| 1BT9-24SP | G1.1/2"X11 | R1.1/2"X11 | | 57.5 | 62 | 48 | | |
| 1BT9-24-20SP | G1.1/2"X11 | R1.1/4"X11 | | 57.5 | 61 | 48 | | |
| 1BT9-24-32SP | G1.1/2"X11 | R2"X11 | | 66 | 75 | 63 | | |
| 1BT9-32SP | G2"X11 | R2"X11 | | 67 | 75 | 63 | | |
| 1BT9-32-24SP | G2"X11 | R1.1/2"X11 | | 68 | 72 | 63 | | |

英管螺纹60°锥面密封接头 BSP Thread 60° Cone Fittings

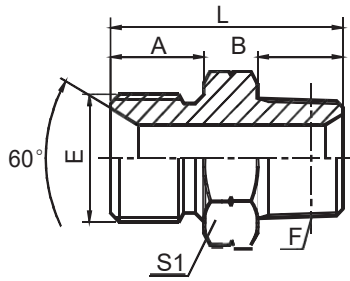

1BT-SP

英管外螺纹60°内锥或六角端面用
组合垫密封 / 英锥管外螺纹

BSP MALE DOUBLE USE FOR 60° CONE SEAT OR
BONDED SEAL / BSPT MALE

| 代号 PART NO. | 螺纹 THREAD | | 尺寸 DIMENSIONS | | | | |
|----------------|------------|------------|---------------|------|------|-----|--|
| | E | F | A | B | L | S1 | |
| 1BT-02SP | G1/8"X28 | R1/8"X28 | 10 | 10 | 26 | 14 | |
| 1BT-02-04SP | G1/8"X28 | R1/4"X19 | 10 | 14.5 | 30.5 | 14 | |
| 1BT-04SP | G1/4"X19 | R1/4"X19 | 12 | 14.5 | 32 | 19 | |
| 1BT-04-02SP | G1/4"X19 | R1/8"X28 | 12 | 10 | 28 | 19 | |
| 1BT-04-06SP | G1/4"X19 | R3/8"X19 | 12 | 15 | 32 | 19 | |
| 1BT-04-08SP | G1/4"X19 | R1/2"X14 | 12 | 20 | 40 | 24 | |
| 1BT-06SP | G3/8"X19 | R3/8"X19 | 13.5 | 15 | 35.5 | 22 | |
| 1BT-06-04SP | G3/8"X19 | R1/4"X19 | 13.5 | 14.5 | 35.5 | 22 | |
| 1BT-06-08SP | G3/8"X19 | R1/2"X14 | 13.5 | 20 | 40.5 | 24 | |
| 1BT-08SP | G1/2"X14 | R1/2"X14 | 16 | 20 | 45 | 27 | |
| 1BT-08-04SP | G1/2"X14 | R1/4"X19 | 16 | 14.5 | 40.5 | 27 | |
| 1BT-08-06SP | G1/2"X14 | R3/8"X19 | 16 | 15 | 40 | 27 | |
| 1BT-08-12SP | G1/2"X14 | R3/4"X14 | 16 | 20 | 45 | 30 | |
| 1BT-10-06SP | G5/8"X14 | R3/8"X19 | 17.5 | 15 | 41.5 | 30 | |
| 1BT-10-08SP | G5/8"X14 | R1/2"X14 | 17.5 | 20 | 46.5 | 30 | |
| 1BT-10-12SP | G5/8"X14 | R3/4"X14 | 17.5 | 20 | 46.5 | 30 | |
| 1BT-10-16SP | G5/8"X14 | R1"X11 | 17.5 | 25.5 | 54 | 36 | |
| 1BT-12SP | G3/4"X14 | R3/4"X14 | 18.5 | 20 | 48.5 | 32 | |
| 1BT-12-08SP | G3/4"X14 | R1/2"X14 | 18.5 | 20 | 48.5 | 32 | |
| 1BT-12-16SP | G3/4"X14 | R1"X11 | 18.5 | 25.5 | 53.5 | 36 | |
| 1BT-12-20SP | G3/4"X14 | R1.1/4"X11 | 18.5 | 26.5 | 58 | 46 | |
| 1BT-16SP | G1"X11 | R1"X11 | 20.5 | 25.5 | 58 | 41 | |
| 1BT-16-12SP | G1"X11 | R3/4"X14 | 20.5 | 20 | 53 | 41 | |
| 1BT-16-20SP | G1"X11 | R1.1/4"X11 | 20.5 | 26.5 | 60 | 46 | |
| 1BT-20SP | G1.1/4"X11 | R1.1/4"X11 | 20.5 | 26.5 | 62 | 50 | |
| 1BT-20-12SP | G1.1/4"X11 | R3/4"X14 | 20.5 | 20.5 | 56 | 50 | |
| 1BT-20-16SP | G1.1/4"X11 | R1"X11 | 20.5 | 25.5 | 61 | 50 | |
| 1BT-20-24SP | G1.1/4"X11 | R1.1/2"X11 | 20.5 | 26.5 | 62 | 50 | |
| 1BT-24SP | G1.1/2"X11 | R1.1/2"X11 | 23 | 26.5 | 64.5 | 55 | |
| 1BT-24-16SP | G1.1/2"X11 | R1"X11 | 23 | 25.5 | 63.5 | 55 | |
| 1BT-24-20SP | G1.1/2"X11 | R1.1/4"X11 | 23 | 26.5 | 64.5 | 55 | |
| 1BT-24-32SP | G1.1/2"X11 | R2"X11 | 23 | 30 | 70 | 65 | |
| 1BT-32SP | G2"X11 | R2"X11 | 25.5 | 30 | 72.5 | 70 | |
| 1BT-32-20SP | G2"X11 | R1.1/4"X11 | 25.5 | 27 | 68.5 | 70 | |
| 1BT-32-24SP | G2"X11 | R1.1/2"X11 | 25.5 | 26.5 | 68.5 | 70 | |
| 1BT-40SP | G2.1/2"X11 | R2.1/2"X11 | 32 | 34 | 83 | 90 | |
| 1BT-48SP | G3"X11 | R3"X11 | 36 | 38 | 94 | 100 | |

F

英管螺纹60°锥面密封接头 BSP Thread 60° Cone Fittings

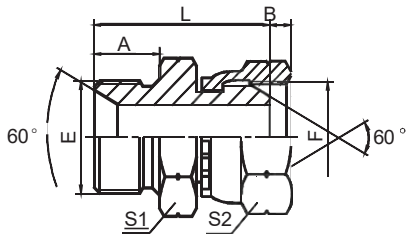

2B

英管外螺纹60° 内锥或六角端面用
组合垫密封 / 英管内螺纹60° 外锥
BSP MALE DOUBLE USE FOR 60° CONE SEAT OR
BONDED SEAL / BSP FEMALE 60° CONE

| 代号 PART NO. | 螺纹 THREAD | | 尺寸 DIMENSIONS | | | | |
|----------------|------------|------------|---------------|------|------|----|----|
| | E | F | A | B | L | S1 | S2 |
| 2B-02 | G1/8"X28 | G1/8"X28 | 10 | 5.5 | 25 | 14 | 14 |
| 2B-02-04 | G1/8"X28 | G1/4"X19 | 10 | 5.5 | 27 | 14 | 19 |
| 2B-04 | G1/4"X19 | G1/4"X19 | 12 | 5.5 | 29 | 19 | 19 |
| 2B-04-06 | G1/4"X19 | G3/8"X19 | 12 | 6.3 | 30.5 | 19 | 22 |
| 2B-04-08 | G1/4"X19 | G1/2"X14 | 12 | 7.5 | 32 | 19 | 27 |
| 2B-06 | G3/8"X19 | G3/8"X19 | 13.5 | 6.3 | 34 | 22 | 22 |
| 2B-06-08 | G3/8"X19 | G1/2"X14 | 13.5 | 7.5 | 35.5 | 22 | 27 |
| 2B-06-10 | G3/8"X19 | G5/8"X14 | 13.5 | 9.5 | 36 | 22 | 30 |
| 2B-08 | G1/2"X14 | G1/2"X14 | 16 | 7.5 | 40 | 27 | 27 |
| 2B-08-06 | G1/2"X14 | G3/8"X19 | 16 | 6.3 | 38.5 | 27 | 22 |
| 2B-08-12 | G1/2"X14 | G3/4"X14 | 16 | 10.9 | 41 | 27 | 32 |
| 2B-10 | G5/8"X14 | G5/8"X14 | 17.5 | 9.5 | 42 | 30 | 30 |
| 2B-10-08 | G5/8"X14 | G1/2"X14 | 18 | 7.5 | 41.5 | 30 | 27 |
| 2B-10-12 | G5/8"X14 | G3/4"X14 | 17.5 | 10.9 | 42.5 | 30 | 32 |
| 2B-12 | G3/4"X14 | G3/4"X14 | 18.5 | 10.9 | 44.5 | 32 | 32 |
| 2B-12-10 | G3/4"X14 | G5/8"X14 | 18.5 | 9.5 | 44 | 32 | 30 |
| 2B-12-16 | G3/4"X14 | G1"X11 | 18.5 | 11.7 | 46 | 32 | 41 |
| 2B-16 | G1"X11 | G1"X11 | 20.5 | 11.7 | 50 | 41 | 41 |
| 2B-16-12 | G1"X11 | G3/4"X14 | 20.5 | 10.9 | 48 | 41 | 32 |
| 2B-16-20 | G1"X11 | G1.1/4"X11 | 20.5 | 11 | 53 | 41 | 50 |
| 2B-20 | G1.1/4"X11 | G1.1/4"X11 | 20.5 | 11 | 55 | 50 | 50 |
| 2B-20-16 | G1.1/4"X11 | G1"X11 | 20.5 | 11.7 | 52 | 50 | 41 |
| 2B-20-24 | G1.1/4"X11 | G1.1/2"X11 | 20.5 | 13 | 55.5 | 50 | 55 |
| 2B-24 | G1.1/2"X11 | G1.1/2"X11 | 23 | 13 | 58 | 55 | 55 |
| 2B-32 | G2"X11 | G2"X11 | 25.5 | 16 | 63.5 | 70 | 70 |

英管螺纹60°锥面密封接头 BSP Thread 60° Cone Fittings

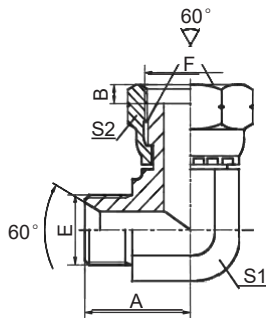

2B9

90° 弯英管外螺纹
60°内锥 / 英管内螺纹60° 外锥
90° ELBOW BSP MALE
60° SEAT / BSP FEMALE 60° CONE

| 代号 PART NO. | 螺 纹 THREAD | | 尺 寸 DIMENSIONS | | | | | | |
|----------------|------------|------------|----------------|--|------|------|----|----|--|
| | E | F | | | A | B | S1 | S2 | |
| 2B9-02 | G1/8"X28 | G1/8"X28 | | | 19.8 | 5.5 | 11 | 14 | |
| 2B9-04 | G1/4"X19 | G1/4"X19 | | | 24.5 | 5.5 | 14 | 19 | |
| 2B9-04-06 | G1/4"X19 | G3/8"X19 | | | 25 | 6.3 | 14 | 22 | |
| 2B9-06 | G3/8"X19 | G3/8"X19 | | | 27.5 | 6.3 | 16 | 22 | |
| 2B9-06-04 | G3/8"X19 | G1/4"X19 | | | 27.5 | 5.5 | 16 | 19 | |
| 2B9-08 | G1/2"X14 | G1/2"X14 | | | 34.5 | 7.5 | 22 | 27 | |
| 2B9-08-06 | G1/2"X14 | G3/8"X19 | | | 34.5 | 6.3 | 22 | 22 | |
| 2B9-10 | G5/8"X14 | G5/8"X14 | | | 35 | 9.5 | 22 | 30 | |
| 2B9-10-08 | G5/8"X14 | G1/2"X14 | | | 35 | 7.5 | 22 | 27 | |
| 2B9-12 | G3/4"X14 | G3/4"X14 | | | 40 | 10.9 | 27 | 32 | |
| 2B9-16 | G1"X11 | G1"X11 | | | 46 | 11.7 | 33 | 41 | |
| 2B9-20 | G1.1/4"X11 | G1.1/4"X11 | | | 50.5 | 11 | 41 | 50 | |
| 2B9-24 | G1.1/2"X11 | G1.1/2"X11 | | | 57.5 | 13 | 48 | 55 | |
| 2B9-32 | G2"X11 | G2"X11 | | | 72.5 | 16 | 63 | 70 | |

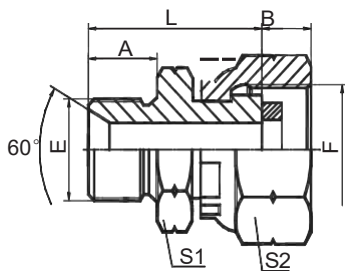

2B-G

英管螺纹60° 内锥 / 英管内螺纹表接头
BSP MALE 60° SEAT /
BSP FEMALE PRESSURE GAUGE CONNECTORS

| 代号 PART NO. | 螺 纹 THREAD | | 紫 铜 片 COPPER WASHER | | 尺 寸 DIMENSIONS | | | | |
|----------------|------------|----------|---------------------|---------|----------------|------|------|----|----|
| | E | F | | F端 | A | B | L | S1 | S2 |
| 2B-02-04G | G1/8"X28 | G1/4"X19 | | DP-B04G | 10 | 14.5 | 24.5 | 14 | 19 |
| 2B-04G | G1/4"X19 | G1/4"X19 | | DP-B04G | 12 | 14.5 | 26.5 | 19 | 19 |
| 2B-04-08G | G1/4"X19 | G1/2"X14 | | DP-B08G | 12 | 20 | 29 | 19 | 27 |
| 2B-06-04G | G3/8"X19 | G1/4"X19 | | DP-B04G | 13.5 | 14.5 | 30 | 22 | 19 |
| 2B-08-04G | G1/2"X14 | G1/4"X19 | | DP-B04G | 16 | 14.5 | 34.5 | 27 | 19 |
| 2B-08G | G1/2"X14 | G1/2"X14 | | DP-B08G | 16 | 20 | 37 | 27 | 27 |

注：紫铜片见Q24页。 Note: The copper washer see page Q24.

英管螺纹60°锥面密封接头 BSP Thread 60° Cone Fittings

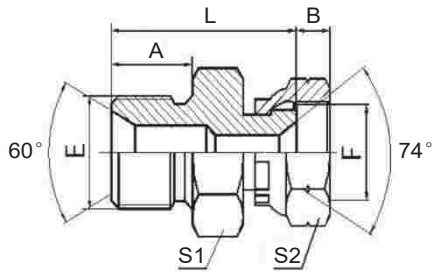

2BJ

英管外螺纹60°内锥或六角端面用组合垫密封 /
美制JIC内螺纹74°内锥
BSP MALE DOUBLE USE FOR 60° CONE SEAT
OR BONDED SEAL / JIC FEMALE 74° SEAT

| 代号 PART NO. | 螺纹 THREAD | | 尺寸 DIMENSIONS | | | | | |
|----------------|------------|------------|---------------|------|------|----|----|--|
| | E | F | A | B | L | S1 | S2 | |
| 2BJ-02-04 | G1/8"X28 | 7/16"X20 | 10 | 9 | 24 | 14 | 15 | |
| 2BJ-02-06 | G1/8"X28 | 9/16"X18 | 10 | 10.5 | 24.5 | 14 | 19 | |
| 2BJ-04 | G1/4"X19 | 7/16"X20 | 12 | 9 | 26 | 19 | 15 | |
| 2BJ-04-05 | G1/4"X19 | 1/2"X20 | 12 | 9.5 | 26.5 | 19 | 17 | |
| 2BJ-04-06 | G1/4"X19 | 9/16"X18 | 12 | 10.5 | 27 | 19 | 19 | |
| 2BJ-04-08 | G1/4"X19 | 3/4"X16 | 12 | 11 | 29 | 19 | 24 | |
| 2BJ-06 | G3/8"X19 | 9/16"X18 | 13.5 | 10.5 | 30.5 | 22 | 19 | |
| 2BJ-06-08 | G3/8"X19 | 3/4"X16 | 13.5 | 11 | 32.5 | 22 | 24 | |
| 2BJ-06-10 | G3/8"X19 | 7/8"X14 | 13.5 | 13 | 33 | 22 | 27 | |
| 2BJ-08 | G1/2"X14 | 3/4"X16 | 16 | 11 | 37 | 27 | 24 | |
| 2BJ-08-06 | G1/2"X14 | 9/16"X18 | 16 | 10.5 | 35 | 27 | 19 | |
| 2BJ-08-10 | G1/2"X14 | 7/8"X14 | 16 | 13 | 37.5 | 27 | 27 | |
| 2BJ-10 | G5/8"X14 | 7/8"X14 | 17.5 | 14 | 37.5 | 30 | 27 | |
| 2BJ-12 | G3/4"X14 | 1.1/16"X12 | 18.5 | 15 | 42 | 32 | 32 | |
| 2BJ-12-08 | G3/4"X14 | 3/4"X16 | 18.5 | 11 | 40 | 32 | 24 | |
| 2BJ-12-10 | G3/4"X14 | 7/8"X14 | 18.5 | 13 | 41 | 32 | 27 | |
| 2BJ-12-16 | G3/4"X14 | 1.5/16"X12 | 18.5 | 16 | 42 | 32 | 41 | |
| 2BJ-16 | G1"X11 | 1.5/16"X12 | 20.5 | 16 | 46 | 41 | 41 | |
| 2BJ-16-20 | G1"X11 | 1.5/8"X12 | 20.5 | 17 | 50 | 41 | 50 | |
| 2BJ-20 | G1.1/4"X11 | 1.5/8"X12 | 20.5 | 17 | 52 | 50 | 50 | |
| 2BJ-20-24 | G1.1/4"X11 | 1.7/8"X12 | 20.5 | 20 | 53.5 | 50 | 55 | |
| 2BJ-24 | G1.1/2"X11 | 1.7/8"X12 | 23 | 20 | 56.5 | 55 | 55 | |
| 2BJ-32 | G2"X11 | 2.1/2"X12 | 25.5 | 24.5 | 60 | 70 | 75 | |

英管螺纹60°锥面密封接头 BSP Thread 60° Cone Fittings

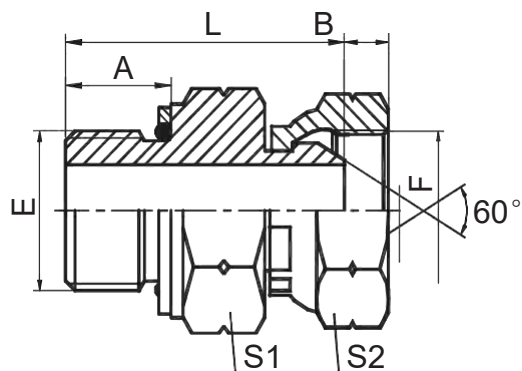

2GB

英管外螺纹O形圈/ 英管内螺纹60°
BSP MALE O-RING / BSP FEMALE 60°

F

| 代号 PART NO. | 螺纹 THREAD | | O形圈 O-RING | | 尺寸 DIMENSIONS | | | | |
|----------------|------------|------------|------------|--|---------------|------|------|----|----|
| | E | F | E端 | | A | B | L | S1 | S2 |
| 2GB-02 | G1/8"X28 | G1/8"X28 | O011 | | 9.5 | 5.5 | 24.5 | 14 | 14 |
| 2GB-04-02 | G1/4"X19 | G1/8"X28 | O111 | | 10 | 5.5 | 25 | 19 | 14 |
| 2GB-04 | G1/4"X19 | G1/4"X19 | O111 | | 11 | 5.5 | 29.5 | 19 | 19 |
| 2GB-04-06 | G1/4"X19 | G3/8"X19 | O111 | | 10 | 6.3 | 28.2 | 19 | 22 |
| 2GB-06 | G3/8"X19 | G3/8"X19 | O113 | | 11.5 | 6.3 | 32 | 24 | 22 |
| 2GB-06-04 | G3/8"X19 | G1/4"X19 | O113 | | 11.5 | 5.5 | 30.5 | 24 | 19 |
| 2GB-06-08 | G3/8"X19 | G1/2"X14 | O113 | | 11.5 | 7.5 | 34 | 24 | 27 |
| 2GB-08 | G1/2"X14 | G1/2"X14 | O115 | | 14 | 7.5 | 38 | 27 | 27 |
| 2GB-08-06 | G1/2"X14 | G3/8"X19 | O115 | | 14 | 6.3 | 36.2 | 27 | 22 |
| 2GB-08-10 | G1/2"X14 | G5/8"X14 | O115 | | 14 | 9.5 | 38.5 | 27 | 30 |
| 2GB-08-12 | G1/2"X14 | G3/4"X14 | O115 | | 14 | 10.9 | 39.1 | 27 | 32 |
| 2GB-12 | G3/4"X14 | G3/4"X14 | O119 | | 15.5 | 10.9 | 41 | 36 | 32 |
| 2GB-12-08 | G3/4"X14 | G1/2"X14 | O119 | | 15.5 | 7.5 | 39.5 | 36 | 27 |
| 2GB-12-16 | G3/4"X14 | G1"X11 | O119 | | 15.5 | 11.7 | 41.8 | 36 | 41 |
| 2GB-16 | G1"X11 | G1"X11 | O217 | | 18 | 11.7 | 46.5 | 41 | 41 |
| 2GB-16-12 | G1"X11 | G3/4"X14 | O217 | | 18 | 10.9 | 46.1 | 41 | 32 |
| 2GB-20 | G1.1/4"X11 | G1.1/4"X11 | O222 | | 20 | 11 | 55 | 50 | 50 |
| 2GB-20-16 | G1.1/4"X11 | G1"X11 | O222 | | 20 | 11.7 | 51.3 | 50 | 41 |
| 2GB-24 | G1.1/2"X11 | G1.1/2"X11 | O224 | | 21.5 | 13 | 55.5 | 60 | 55 |

英管螺纹60°锥面密封接头 BSP Thread 60° Cone Fittings

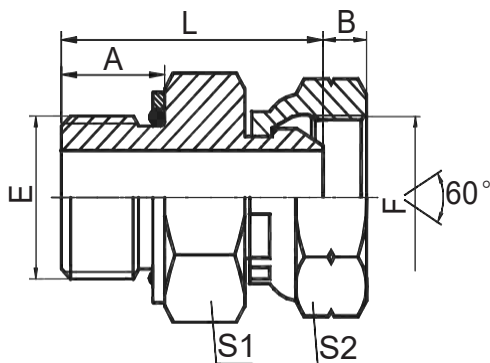

2HB

公制外螺纹O形圈/ 英制内螺纹60° 外锥面
METRIC MALE O-RING / BSPP FEMALE 60° CONE

| 代号 PART NO. | 螺纹 THREAD | | O形圈 O-RING | | 尺寸 DIMENSIONS | | | | |
|----------------|-----------|------------|------------|--|---------------|------|------|----|----|
| | E | F | E端 | | A | B | L | S1 | |
| 2HB-10-02 | M10X1 | G1/8"X28 | 8.1X1.6 | | 8.5 | 5.5 | 23.5 | 14 | 14 |
| 2HB-12-04 | M12X1.5 | G1/4"X19 | 9.3X2.4 | | 11 | 5.5 | 28 | 17 | 19 |
| 2HB-14-04 | M14X1.5 | G1/4"X19 | 11.3X2.4 | | 11 | 5.5 | 28 | 19 | 19 |
| 2HB-16-06 | M16X1.5 | G3/8"X19 | 13.3X2.4 | | 11.5 | 6.3 | 31.7 | 22 | 22 |
| 2HB-18-06 | M18X1.5 | G3/8"X19 | 15.3X2.4 | | 12.5 | 6.3 | 32.7 | 24 | 22 |
| 2HB-18-08 | M18X1.5 | G1/2"X14 | 15.3X2.4 | | 12.5 | 7.5 | 34.5 | 24 | 27 |
| 2HB-22-08 | M22X1.5 | G1/2"X14 | 19.3X2.4 | | 13 | 7.5 | 37 | 27 | 27 |
| 2HB-22-10 | M22X1.5 | G5/8"X14 | 19.3X2.4 | | 13 | 9.5 | 37.5 | 27 | 30 |
| 2HB-22-12 | M22X1.5 | G3/4"X14 | 19.3X2.4 | | 13 | 10.9 | 38.1 | 27 | 32 |
| 2HB-27-12 | M27X2 | G3/4"X14 | 23.5X3 | | 16 | 10.9 | 44.5 | 32 | 32 |
| 2HB-27-16 | M27X2 | G1"X11 | 23.5X3 | | 16 | 11.7 | 43.3 | 32 | 41 |
| 2HB-33-16 | M33X2 | G1"X11 | 29.2X3 | | 16 | 11.7 | 45.3 | 41 | 41 |
| 2HB-42-20 | M42X2 | G1.1/4"X11 | 38.5X3 | | 16 | 11 | 49.5 | 50 | 50 |
| 2HB-48-24 | M48X2 | G1.1/2"X11 | 44.5X3 | | 17.5 | 13 | 51.5 | 55 | 55 |

注：可与ISO 9974-1油口相配，去掉挡圈与ISO 6149-1油口相配。Note: fit for ISO 9974-1 port or ISO 6149-1 port when useless of retaining ring.

英管螺纹60°锥面密封接头 BSP Thread 60° Cone Fittings

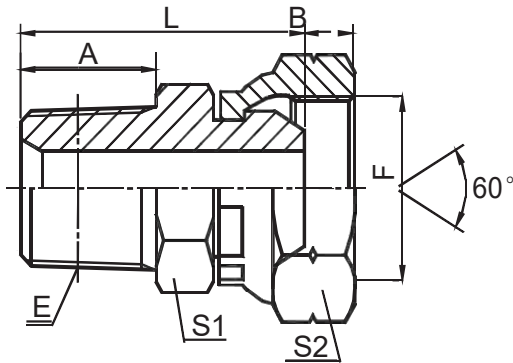

2NB

布锥管外螺纹 / 英管内螺纹60° 外锥
NPT MALE / BSP FEMALE 60° CONE

F

| 代号 PART NO. | 螺纹 THREAD | | 尺寸 DIMENSIONS | | | | | | |
|----------------|--------------|------------|---------------|------|------|----|----|--|--|
| | E | F | A | B | L | S1 | S2 | | |
| 2NB-02 | Z1/8"X27 | G1/8"X28 | 10.5 | 5.5 | 25.5 | 12 | 14 | | |
| 2NB-02-04 | Z1/8"X27 | G1/4"X19 | 10.5 | 5.5 | 27 | 14 | 19 | | |
| 2NB-04 | Z1/4"X18 | G1/4"X19 | 15 | 5.5 | 31 | 17 | 19 | | |
| 2NB-04-06 | Z1/4"X18 | G3/8"X19 | 15 | 6.3 | 32.5 | 17 | 22 | | |
| 2NB-04-08 | Z1/4"X18 | G1/2"X14 | 15 | 7.5 | 35 | 19 | 27 | | |
| 2NB-06 | Z3/8"X18 | G3/8"X19 | 16 | 6.3 | 33.5 | 19 | 22 | | |
| 2NB-06-08 | Z3/8"X18 | G1/2"X14 | 16 | 7.5 | 36 | 19 | 27 | | |
| 2NB-08 | Z1/2"X14 | G1/2"X14 | 19.5 | 7.5 | 41 | 22 | 27 | | |
| 2NB-08-06 | Z1/2"X14 | G3/8"X19 | 19.5 | 6.3 | 39.5 | 24 | 24 | | |
| 2NB-08-12 | Z1/2"X14 | G3/4"X14 | 19.5 | 10.9 | 44.5 | 27 | 32 | | |
| 2NB-12 | Z3/4"X14 | G3/4"X14 | 19.5 | 10.9 | 44.5 | 30 | 32 | | |
| 2NB-12-16 | Z3/4"X14 | G1"X11 | 19.5 | 11.7 | 46.5 | 32 | 41 | | |
| 2NB-16 | Z1"X11.5 | G1"X11 | 25.5 | 11.7 | 52.5 | 36 | 41 | | |
| 2NB-16-20 | Z1"X11.5 | G1.1/4"X11 | 25.5 | 11 | 59.5 | 41 | 50 | | |
| 2NB-20 | Z1.1/4"X11.5 | G1.1/4"X11 | 26.5 | 11 | 59.5 | 46 | 50 | | |
| 2NB-24 | Z1.1/2"X11.5 | G1.1/2"X11 | 27.5 | 13 | 62 | 50 | 55 | | |
| 2NB-32 | Z2"X11.5 | G2"X11 | 27.5 | 20 | 64.5 | 65 | 70 | | |

英管螺纹60°锥面密封接头 BSP Thread 60° Cone Fittings

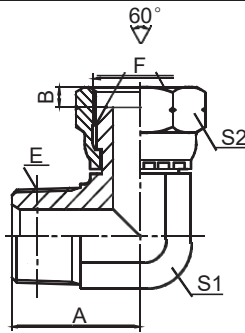

2TB9-SP

90° 弯英锥管外螺纹 / 英管内螺纹60° 外锥
90° ELBOW BSPT MALE / BSP FEMALE 60° CONE

| 代号 PART NO. | 螺纹 THREAD | | 尺寸 DIMENSIONS | | | | | |
|----------------|------------|------------|---------------|------|----|----|--|--|
| | E | F | A | B | S1 | S2 | | |
| 2TB9-02SP | R1/8"X28 | G1/8"X28 | 21 | 5.5 | 11 | 14 | | |
| 2TB9-04SP | R1/4"X19 | G1/4"X19 | 25.5 | 5.5 | 14 | 19 | | |
| 2TB9-06SP | R3/8"X19 | G3/8"X19 | 28.5 | 6.3 | 16 | 22 | | |
| 2TB9-06-08SP | R3/8"X19 | G1/2"X14 | 31 | 7.5 | 19 | 27 | | |
| 2TB9-08-06SP | R1/2"X14 | G3/8"X19 | 36 | 6.3 | 22 | 22 | | |
| 2TB9-08SP | R1/2"X14 | G1/2"X14 | 36 | 7.5 | 22 | 27 | | |
| 2TB9-08-12SP | R1/2"X14 | G3/4"X14 | 37 | 10.9 | 24 | 32 | | |
| 2TB9-12-08SP | R3/4"X14 | G1/2"X14 | 43.5 | 7.5 | 27 | 27 | | |
| 2TB9-12SP | R3/4"X14 | G3/4"X14 | 43.5 | 10.9 | 27 | 32 | | |
| 2TB9-16SP | R1"X11 | G1"X11 | 50 | 11.7 | 33 | 41 | | |
| 2TB9-20SP | R1.1/4"X11 | G1.1/4"X11 | 57 | 11 | 41 | 50 | | |
| 2TB9-24SP | R1.1/2"X11 | G1.1/2"X11 | 62.5 | 13 | 48 | 55 | | |

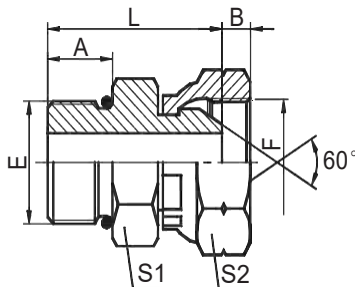

2OB

SAE外螺纹带O形圈/ 英管内螺纹60° 外锥
SAE O-RING BOSS / BSP FEMALE 60° CONE

| 代号 PART NO. | 螺纹 THREAD | | O形圈 O-RING | 尺寸 DIMENSIONS | | | | | |
|----------------|------------|------------|------------|---------------|------|------|----|----|--|
| | E | F | E 端 | A | B | L | S1 | S2 | |
| 2OB-04 | 7/16"X20 | G1/4"X19 | O904 | 9.1 | 5.5 | 26.2 | 14 | 19 | |
| 2OB-04-06 | 7/16"X20 | G3/8"X19 | O904 | 9.1 | 6.3 | 27 | 17 | 22 | |
| 2OB-05-06 | 1/2"X20 | G3/8"X19 | O905 | 9.1 | 6.3 | 27.5 | 17 | 22 | |
| 2OB-06 | 9/16"X18 | G3/8"X19 | O906 | 9.9 | 6.3 | 28 | 17 | 22 | |
| 2OB-06-04 | 9/16"X18 | G1/4"X19 | O906 | 9.9 | 5.5 | 27 | 17 | 19 | |
| 2OB-06-08 | 9/16"X18 | G1/2"X14 | O906 | 9.9 | 7.5 | 30 | 19 | 27 | |
| 2OB-08 | 3/4"X16 | G1/2"X14 | O908 | 11.1 | 7.5 | 33 | 22 | 27 | |
| 2OB-08-06 | 3/4"X16 | G3/8"X19 | O908 | 11.1 | 6.3 | 31 | 22 | 22 | |
| 2OB-08-12 | 3/4"X16 | G3/4"X14 | O908 | 11.1 | 10.9 | 36 | 27 | 32 | |
| 2OB-10-06 | 7/8"X14 | G3/8"X19 | O910 | 12.7 | 6.3 | 35 | 27 | 22 | |
| 2OB-10-08 | 7/8"X14 | G1/2"X14 | O910 | 12.7 | 7.5 | 36.5 | 27 | 27 | |
| 2OB-10-12 | 7/8"X14 | G3/4"X14 | O910 | 12.7 | 10.9 | 37.5 | 27 | 32 | |
| 2OB-12-08 | 1.1/16"X12 | G1/2"X14 | O912 | 15.1 | 7.5 | 40 | 32 | 27 | |
| 2OB-12 | 1.1/16"X12 | G3/4"X14 | O912 | 15.1 | 10.9 | 41 | 32 | 32 | |
| 2OB-12-16 | 1.1/16"X12 | G1"X11 | O912 | 15.1 | 11.7 | 42 | 32 | 41 | |
| 2OB-16-12 | 1.5/16"X12 | G3/4"X14 | O916 | 15.1 | 10.9 | 41 | 38 | 32 | |
| 2OB-16 | 1.5/16"X12 | G1"X11 | O916 | 15.1 | 11.7 | 42 | 38 | 41 | |
| 2OB-16-20 | 1.5/16"X12 | G1.1/4"X11 | O916 | 15.1 | 11 | 48 | 41 | 50 | |
| 2OB-20 | 1.5/8"X12 | G1.1/4"X11 | O920 | 15.1 | 11 | 49.5 | 50 | 50 | |
| 2OB-20-24 | 1.5/8"X12 | G1.1/2"X11 | O920 | 15.1 | 13 | 50 | 50 | 55 | |
| 2OB-24 | 1.7/8"X12 | G1.1/2"X11 | O924 | 15.1 | 13 | 50 | 55 | 55 | |

英管螺纹60°锥面密封接头 BSP Thread 60° Cone Fittings

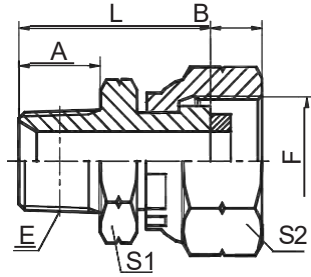

2TB-GSP

英锥管外螺纹 / 英管内螺纹表接头
BSPT MALE / BSP FEMALE PRESSURE GAUGE CONNECTORS

| 代号 PART NO. | 螺纹 THREAD | | 紫铜片COPPER WASHER | F端 | 尺寸 DIMENSIONS | | | | |
|----------------|-----------|----------|------------------|---------|---------------|------|------|----|----|
| | E | F | | | A | B | L | S1 | S2 |
| 2TB-02-04GSP | R1/8"X28 | G1/4"X19 | | DP-B04G | 10 | 14.5 | 24.5 | 12 | 19 |
| 2TB-04GSP | R1/4"X19 | G1/4"X19 | | DP-B04G | 14.5 | 14.5 | 29 | 17 | 19 |
| 2TB-04-08GSP | R1/4"X19 | G1/2"X14 | | DP-B08G | 14.5 | 20 | 31.5 | 19 | 27 |
| 2TB-06-04GSP | R3/8"X19 | G1/4"X19 | | DP-B04G | 15 | 14.5 | 29.5 | 19 | 19 |
| 2TB-08-04GSP | R1/2"X14 | G1/4"X19 | | DP-B04G | 20 | 14.5 | 36.5 | 22 | 19 |
| 2TB-08GSP | R1/2"X14 | G1/2"X14 | | DP-B08G | 20 | 20 | 39 | 22 | 27 |

F

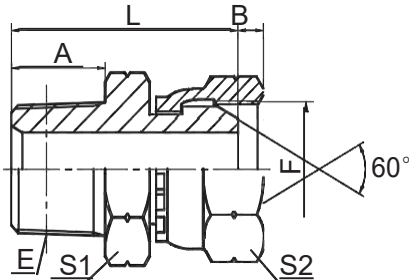

2TB-SP

英锥管外螺纹 / 英管内螺纹60°外锥
BSPT MALE / BSP FEMALE 60° CONE

| 代号 PART NO. | 螺纹 THREAD | | | | 尺寸 DIMENSIONS | | | | |
|----------------|------------|------------|--|--|---------------|------|------|----|----|
| | E | F | | | A | B | L | S1 | S2 |
| 2TB-02SP | R1/8"X28 | G1/8"X28 | | | 10 | 5.5 | 25 | 12 | 14 |
| 2TB-04SP | R1/4"X19 | G1/4"X19 | | | 14.5 | 5.5 | 31.5 | 17 | 19 |
| 2TB-06SP | R3/8"X19 | G3/8"X19 | | | 15 | 6.3 | 33 | 19 | 22 |
| 2TB-06-04SP | R3/8"X19 | G1/4"X19 | | | 15 | 5.5 | 32 | 19 | 19 |
| 2TB-06-08SP | R3/8"X19 | G1/2"X14 | | | 15 | 7.5 | 35 | 19 | 27 |
| 2TB-08SP | R1/2"X14 | G1/2"X14 | | | 20 | 7.5 | 42 | 22 | 27 |
| 2TB-08-06SP | R1/2"X14 | G3/8"X19 | | | 20 | 6.3 | 40 | 22 | 22 |
| 2TB-08-12SP | R1/2"X14 | G3/4"X14 | | | 20 | 10.9 | 45 | 27 | 32 |
| 2TB-12SP | R3/4"X14 | G3/4"X14 | | | 20 | 10.9 | 45 | 30 | 32 |
| 2TB-12-08SP | R3/4"X14 | G1/2"X14 | | | 20 | 7.5 | 44 | 30 | 27 |
| 2TB-12-16SP | R3/4"X14 | G1"X11 | | | 20 | 11.7 | 47 | 32 | 41 |
| 2TB-16SP | R1"X11 | G1"X11 | | | 25.5 | 11.7 | 52.5 | 36 | 41 |
| 2TB-16-12SP | R1"X11 | G3/4"X14 | | | 25.5 | 10.9 | 51.5 | 36 | 32 |
| 2TB-20-16SP | R1.1/4"X11 | G1"X11 | | | 26.5 | 11.7 | 55.5 | 46 | 41 |
| 2TB-20SP | R1.1/4"X11 | G1.1/4"X11 | | | 26.5 | 11 | 59 | 46 | 50 |
| 2TB-24SP | R1.1/2"X11 | G1.1/2"X11 | | | 26.5 | 13 | 61.5 | 50 | 55 |
| 2TB-32SP | R2"X11 | G2"X11 | | | 30 | 16 | 67 | 65 | 70 |

英管螺纹60°锥面密封接头 BSP Thread 60° Cone Fittings

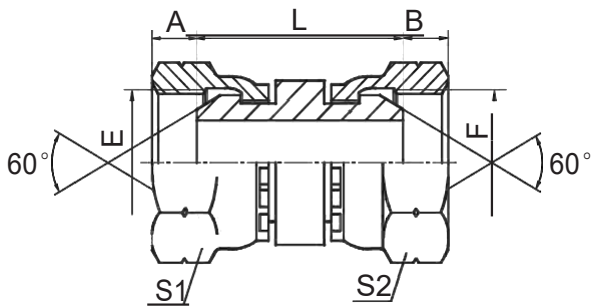

3B

英管内螺纹60°外锥
BSP FEMALE 60° CONE

| 代号 PART NO. | 螺纹 THREAD | | 尺寸 DIMENSIONS | | | | | | |
|----------------|------------|------------|---------------|--|------|------|------|----|----|
| | E | F | | | A | B | L | S1 | S2 |
| 3B-02 | G1/8"X28 | G1/8"X28 | | | 5.5 | 5.5 | 21 | 14 | 14 |
| 3B-02-04 | G1/8"X28 | G1/4"X19 | | | 5.5 | 5.5 | 23 | 14 | 19 |
| 3B-04 | G1/4"X19 | G1/4"X19 | | | 5.5 | 5.5 | 25 | 19 | 19 |
| 3B-04-06 | G1/4"X19 | G3/8"X19 | | | 5.5 | 6.3 | 26.5 | 19 | 22 |
| 3B-04-08 | G1/4"X19 | G1/2"X14 | | | 5.5 | 7.5 | 28.5 | 19 | 27 |
| 3B-06 | G3/8"X19 | G3/8"X19 | | | 6.3 | 6.3 | 27 | 22 | 22 |
| 3B-06-08 | G3/8"X19 | G1/2"X14 | | | 6.3 | 7.5 | 29.5 | 22 | 27 |
| 3B-08 | G1/2"X14 | G1/2"X14 | | | 7.5 | 7.5 | 31 | 27 | 27 |
| 3B-08-10 | G1/2"X14 | G5/8"X14 | | | 7.5 | 9.5 | 31.5 | 27 | 30 |
| 3B-08-12 | G1/2"X14 | G3/4"X14 | | | 7.5 | 10.9 | 32.5 | 27 | 32 |
| 3B-10 | G5/8"X14 | G5/8"X14 | | | 9.5 | 9.5 | 31.5 | 30 | 30 |
| 3B-10-12 | G5/8"X14 | G3/4"X14 | | | 9.5 | 10.9 | 33 | 30 | 32 |
| 3B-12 | G3/4"X14 | G3/4"X14 | | | 10.9 | 10.9 | 33.5 | 32 | 32 |
| 3B-12-16 | G3/4"X14 | G1"X11 | | | 10.9 | 11.7 | 35 | 32 | 41 |
| 3B-16 | G1"X11 | G1"X11 | | | 11.7 | 11.7 | 36.5 | 41 | 41 |
| 3B-16-20 | G1"X11 | G1.1/4"X11 | | | 11.7 | 11 | 39 | 41 | 50 |
| 3B-20 | G1.1/4"X11 | G1.1/4"X11 | | | 11 | 11 | 40 | 50 | 50 |
| 3B-24 | G1.1/2"X11 | G1.1/2"X11 | | | 13 | 13 | 42 | 55 | 55 |
| 3B-32 | G2"X11 | G2"X11 | | | 16 | 16 | 47 | 70 | 70 |

英管螺纹60°锥面密封接头 BSP Thread 60° Cone Fittings

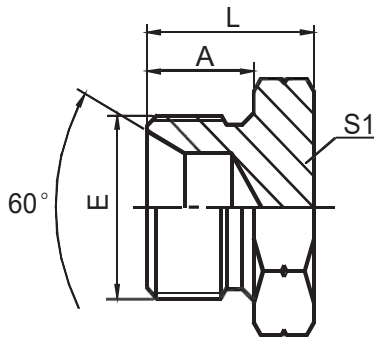

4B

英管外螺纹60°内锥或六角端面用组合垫密封堵头
 BSP MALE DOUBLE USE FOR 60° CONE SEAT OR BONDED SEAL PLUG

| 代号 PART NO. | 螺纹 THREAD | | | 尺寸 DIMENSIONS | | | | |
|----------------|------------|--|--|---------------|------|----|--|--|
| | E | | | A | L | S1 | | |
| 4B-02 | G1/8"X28 | | | 10 | 16 | 14 | | |
| 4B-04 | G1/4"X19 | | | 12 | 18 | 19 | | |
| 4B-06 | G3/8"X19 | | | 13.5 | 21.5 | 22 | | |
| 4B-08 | G1/2"X14 | | | 16 | 26 | 27 | | |
| 4B-10 | G5/8"X14 | | | 17.5 | 27.5 | 30 | | |
| 4B-12 | G3/4"X14 | | | 18.5 | 29.5 | 32 | | |
| 4B-16 | G1"X11 | | | 20.5 | 34 | 41 | | |
| 4B-20 | G1.1/4"X11 | | | 20.5 | 37.5 | 50 | | |
| 4B-24 | G1.1/2"X11 | | | 23 | 40 | 55 | | |
| 4B-32 | G2"X11 | | | 25.5 | 43.5 | 70 | | |

F

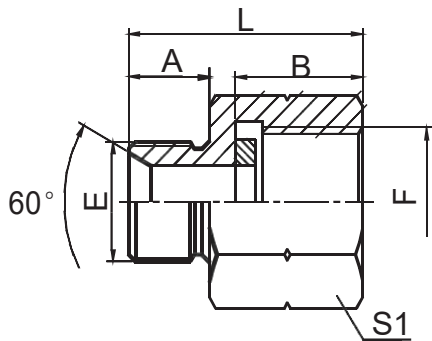

5B-G

英管外螺纹60°内锥或六角端面用组合垫密封 / 英管内螺纹表接头
 BSP MALE DOUBLE USE FOR 60° CONE SEAT OR BONDED SEAL / BSP FEMALE PRESSURE GAUGE CONNECTORS

| 代号 PART NO. | 螺纹 THREAD | | 紫铜片 COPPER WASHER | 尺寸 DIMENSIONS | | | | |
|----------------|-----------|----------|-------------------|---------------|----|------|----|--|
| | E | F | F端 | A | B | L | S1 | |
| 5B-04G | G1/4"x19 | G1/4"X19 | DP-B04G | 12 | 11 | 26 | 19 | |
| 5B-06-04G | G3/8"x19 | G1/4"X19 | DP-B04G | 13.5 | 11 | 28.5 | 22 | |
| 5B-06-08G | G3/8"x19 | G1/2"X14 | DP-B08G | 13.5 | 17 | 35.5 | 27 | |
| 5B-08G | G1/2"x14 | G1/2"X14 | DP-B08G | 16 | 17 | 37 | 27 | |

注：紫铜片见Q24页。Note: The copper washer see page Q24.

英管螺纹60°锥面密封接头 BSP Thread 60° Cone Fittings

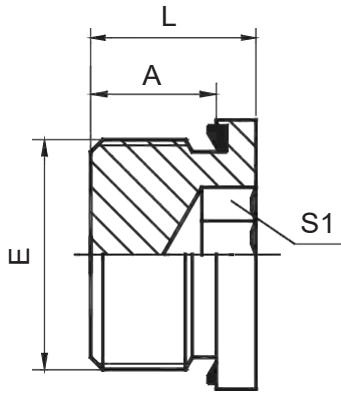

4BN-WD

英管外螺纹胶垫密封内六角堵头
BSP MALE CAPTIVE SEAL HOLLOW HEX PLUG

| 代号 PART NO. | 螺 纹 THREAD | | 胶 垫 CAPTIVE | | 尺 寸 DIMENSIONS | | | |
|----------------|------------|--|-------------|--|----------------|------|----|--|
| | E | | E端 | | A | L | S1 | |
| 4BN-02WD | G1/8"X28 | | WD-B02 | | 8 | 12.2 | 5 | |
| 4BN-04WD | G1/4"X19 | | WD-B04 | | 12 | 17.2 | 6 | |
| 4BN-06WD | G3/8"X19 | | WD-B06 | | 12 | 17.2 | 8 | |
| 4BN-08WD | G1/2"X14 | | WD-B08 | | 14 | 19.2 | 10 | |
| 4BN-12WD | G3/4"X14 | | WD-B12 | | 16 | 21.2 | 12 | |
| 4BN-16WD | G1"X11 | | WD-B16 | | 16 | 22.8 | 17 | |
| 4BN-20WD | G1.1/4"X11 | | WD-B20 | | 20 | 26.8 | 22 | |
| 4BN-24WD | G1.1/2"X11 | | WD-B24 | | 22 | 28.8 | 24 | |

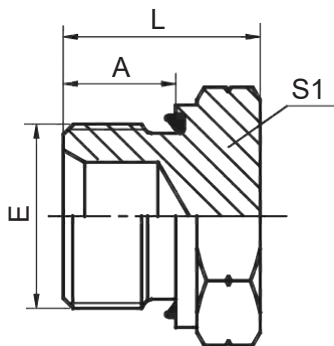

4B-WD

英管外螺纹胶垫密封堵头
BSP MALE CAPTIVE SEAL PLUG

| 代号 PART NO. | 螺 纹 THREAD | | 胶 垫 CAPTIVE | | 尺 寸 DIMENSIONS | | | |
|----------------|------------|--|-------------|--|----------------|------|----|--|
| | E | | E端 | | A | L | S1 | |
| 4B-02WD | G1/8"X28 | | WD-B02 | | 8 | 15.5 | 14 | |
| 4B-04WD | G1/4"X19 | | WD-B04 | | 12 | 19.6 | 19 | |
| 4B-06WD | G3/8"X19 | | WD-B06 | | 12 | 22.5 | 22 | |
| 4B-08WD | G1/2"X14 | | WD-B08 | | 14 | 25 | 27 | |
| 4B-12WD | G3/4"X14 | | WD-B12 | | 16 | 29 | 32 | |
| 4B-16WD | G1"X11 | | WD-B16 | | 18 | 35 | 41 | |
| 4B-20WD | G1.1/4"X11 | | WD-B20 | | 20 | 37 | 50 | |
| 4B-24WD | G1.1/2"X11 | | WD-B24 | | 22 | 40 | 55 | |

英管螺纹60°锥面密封接头 BSP Thread 60° Cone Fittings

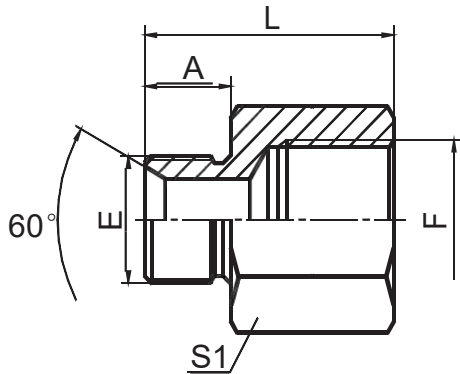

5B

英管外螺纹60°内锥或六角端面用
 组合垫密封 / 英管内螺纹 ISO 1179
 BSP MALE DOUBLE USE FOR 60° CONE SEAT
 OR BONDED SEAL / BSP FEMALE ISO 1179

F

| 代号 PART NO. | 螺纹 THREAD | | 尺寸 DIMENSIONS | | | | | | |
|----------------|------------|------------|---------------|--|------|------|----|--|--|
| | E | F | | | A | L | S1 | | |
| 5B-02-04 | G1/8"X28 | G1/4"X19 | | | 10 | 29 | 19 | | |
| 5B-04-02 | G1/4"X19 | G 1/8"X28 | | | 12 | 28 | 19 | | |
| 5B-04 | G1/4"X19 | G1/4"X19 | | | 12 | 33 | 19 | | |
| 5B-04-06 | G1/4"X19 | G3/8"X19 | | | 12 | 36 | 22 | | |
| 5B-06-04 | G3/8"X19 | G1/4"X19 | | | 13.5 | 33.5 | 22 | | |
| 5B-06 | G3/8"X19 | G3/8"X19 | | | 13.5 | 37.5 | 22 | | |
| 5B-06-08 | G3/8"X19 | G1/2"X14 | | | 13.5 | 42.5 | 27 | | |
| 5B-08-06 | G1/2"X14 | G3/8"X19 | | | 16 | 38 | 27 | | |
| 5B-08 | G1/2"X14 | G1/2"X14 | | | 16 | 45 | 27 | | |
| 5B-08-10 | G1/2"X14 | G5/8"X14 | | | 16 | 46 | 30 | | |
| 5B-08-12 | G1/2"X14 | G3/4"X14 | | | 16 | 44.5 | 36 | | |
| 5B-10-08 | G5/8"X14 | G1/2"X14 | | | 16 | 41.5 | 30 | | |
| 5B-12-08 | G3/4"X14 | G1/2"X14 | | | 18.5 | 44.5 | 32 | | |
| 5B-12 | G3/4"X14 | G3/4"X14 | | | 18.5 | 48 | 36 | | |
| 5B-12-16 | G3/4"X14 | G1"X11 | | | 18.5 | 53.5 | 41 | | |
| 5B-16-12 | G1"X11 | G3/4"X14 | | | 20.5 | 47.5 | 41 | | |
| 5B-16 | G1"X11 | G1"X11 | | | 20.5 | 55.5 | 41 | | |
| 5B-16-20 | G1"X11 | G1.1/4"X11 | | | 20.5 | 56.5 | 50 | | |
| 5B-20-16 | G1.1/4"X11 | G1"X11 | | | 20.5 | 49 | 50 | | |
| 5B-20 | G1.1/4"X11 | G1.1/4"X11 | | | 20.5 | 52.5 | 50 | | |
| 5B-20-24 | G1.1/4"X11 | G1.1/2"X11 | | | 20.5 | 57.5 | 55 | | |
| 5B-24 | G1.1/2"X11 | G1.1/2"X11 | | | 23 | 58 | 55 | | |
| 5B-32-24 | G2"X11 | G1.1/2"X11 | | | 26 | 59.5 | 70 | | |
| 5B-32 | G2"X11 | G2"X11 | | | 25.5 | 62 | 70 | | |

英管螺纹60°锥面密封接头 BSP Thread 60° Cone Fittings

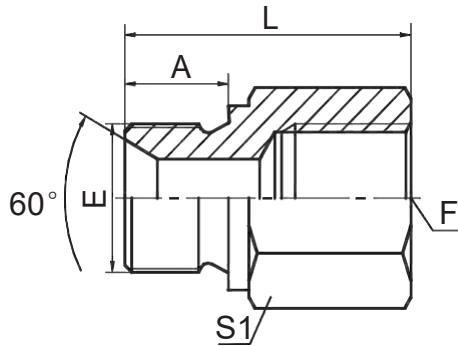

5B-HS

英管外螺纹60°内锥 / 英管内螺纹
BSP MALE 60° SEAT / BSP FEMALE

| 代号 PART NO. | 螺纹 THREAD | | 尺寸 DIMENSIONS | | | | | |
|----------------|------------|------------|---------------|------|------|----|--|--|
| | E | F | | A | L | S1 | | |
| 5B-02-04HS | G1/8"X28 | G1/4"X19 | | 10.2 | 28 | 19 | | |
| 5B-02HS | G1/8"X28 | G1/8"X28 | | 10.2 | 27 | 14 | | |
| 5B-04-02HS | G1/4"X19 | G1/8"X28 | | 11 | 28 | 19 | | |
| 5B-04-06HS | G1/4"X19 | G3/8"X19 | | 11 | 34 | 22 | | |
| 5B-04-08HS | G1/4"X19 | G1/2"X14 | | 11 | 35.8 | 27 | | |
| 5B-04HS | G1/4"X19 | G1/4"X19 | | 11 | 30 | 19 | | |
| 5B-06-04HS | G3/8"X19 | G1/4"X19 | | 12.7 | 32 | 22 | | |
| 5B-06-08HS | G3/8"X19 | G1/2"X14 | | 12.7 | 38 | 27 | | |
| 5B-06HS | G3/8"X19 | G3/8"X19 | | 12.7 | 34 | 22 | | |
| 5B-08-06HS | G1/2"X14 | G3/8"X19 | | 15.2 | 37 | 27 | | |
| 5B-08-10HS | G1/2"X14 | G5/8"X14 | | 15.2 | 42 | 30 | | |
| 5B-08-12HS | G1/2"X14 | G3/4"X14 | | 15.2 | 45 | 32 | | |
| 5B-08HS | G1/2"X14 | G1/2"X14 | | 15.2 | 42 | 27 | | |
| 5B-10-08HS | G5/8"X14 | G1/2"X14 | | 16 | 42 | 30 | | |
| 5B-12-08HS | G3/4"X14 | G1/2"X14 | | 16 | 45 | 32 | | |
| 5B-12-16HS | G3/4"X14 | G1"X11 | | 16 | 48 | 41 | | |
| 5B-12HS | G3/4"X14 | G3/4"X14 | | 16 | 45 | 32 | | |
| 5B-16-12HS | G1"X11 | G3/4"X14 | | 19.1 | 48 | 41 | | |
| 5B-16-20HS | G1"X11 | G1.1/4"X11 | | 19.1 | 52 | 50 | | |
| 5B-16HS | G1"X11 | G1"X11 | | 19.1 | 50 | 41 | | |
| 5B-20-16HS | G1.1/4"X11 | G1"X11 | | 20.3 | 44 | 50 | | |
| 5B-20-24HS | G1.1/4"X11 | G1.1/2"X11 | | 20.3 | 55 | 55 | | |
| 5B-20-32HS | G1.1/4"X11 | G2"X11 | | 20.3 | 62.5 | 70 | | |
| 5B-20HS | G1.1/4"X11 | G1.1/4"X11 | | 20.3 | 55 | 50 | | |
| 5B-24-20HS | G1.1/2"X11 | G1.1/4"X11 | | 22.9 | 55 | 55 | | |
| 5B-24-32HS | G1.1/2"X11 | G2"X11 | | 22.9 | 64 | 70 | | |
| 5B-24HS | G1.1/2"X11 | G1.1/2"X11 | | 22.9 | 56 | 55 | | |
| 5B-32-16HS | G2"X11 | G1"X11 | | 26 | 46.5 | 70 | | |
| 5B-32-24HS | G2"X11 | G1.1/2"X11 | | 26 | 60 | 70 | | |

英管螺纹60°锥面密封接头 BSP Thread 60° Cone Fittings

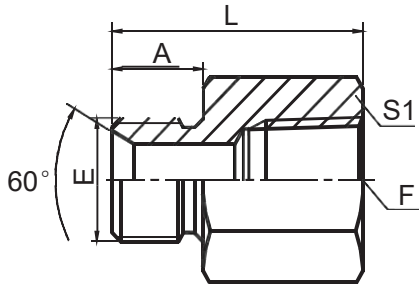

5BN

英管外螺纹60°内锥或六角端面用
组合垫密封 / 美制布锥管内螺纹
BSP MALE DOUBLE USE FOR 60° CONE SEAT OR
BONDED SEAL / NPT FEMALE

| 代号 PART NO. | 螺纹 THREAD | | 尺寸 DIMENSIONS | | | | | |
|----------------|------------|--------------|---------------|------|----|--|--|--|
| | E | F | A | L | S1 | | | |
| 5BN-04 | G1/4"X19 | Z1/4"X18 | 12 | 30 | 19 | | | |
| 5BN-06 | G3/8"X19 | Z3/8"X18 | 13.5 | 33 | 22 | | | |
| 5BN-08 | G1/2"X14 | Z1/2"X14 | 16 | 42 | 30 | | | |
| 5BN-12 | G3/4"X14 | Z3/4"X14 | 18.5 | 44.5 | 36 | | | |
| 5BN-16 | G1"X11 | Z1"X11.5 | 20.5 | 52 | 41 | | | |
| 5BN-20 | G1.1/4"X11 | Z1.1/4"X11.5 | 20.5 | 55 | 50 | | | |
| 5BN-24 | G1.1/2"X11 | Z1.1/2"X11.5 | 23 | 58 | 60 | | | |
| 5BN-32 | G2"X11 | Z2"X11.5 | 25.5 | 62 | 70 | | | |

F

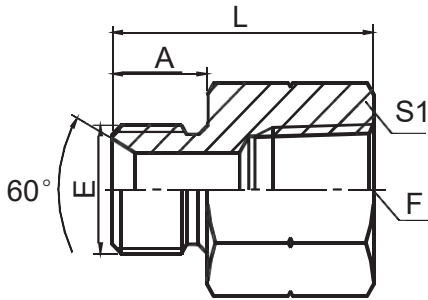

5BT

英管外螺纹60°内锥或六角端面用
组合垫密封 / 英锥管内螺纹
BSP MALE DOUBLE USE FOR 60° CONE SEAT
OR BONDED SEAL / BSPT FEMALE

| 代号 PART NO. | 螺纹 THREAD | | 尺寸 DIMENSIONS | | | | | |
|----------------|------------|-------------|---------------|------|----|--|--|--|
| | E | F | A | L | S1 | | | |
| 5BT-04-02 | G1/4"X19 | Rc1/8"X28 | 12 | 28 | 19 | | | |
| 5BT-04 | G1/4"X19 | Rc1/4"X19 | 12 | 33.5 | 19 | | | |
| 5BT-04-06 | G1/4"X19 | Rc3/8"X19 | 12 | 34 | 22 | | | |
| 5BT-04-08 | G1/4"X19 | Rc1/2"X14 | 13.5 | 41.5 | 27 | | | |
| 5BT-06-04 | G3/8"X19 | Rc1/4"X19 | 13.5 | 32 | 22 | | | |
| 5BT-06 | G3/8"X19 | Rc3/8"X19 | 13.5 | 34 | 22 | | | |
| 5BT-08-06 | G1/2"X14 | Rc3/8"X19 | 16 | 39.5 | 27 | | | |
| 5BT-08 | G1/2"X14 | Rc1/2"X14 | 16 | 45 | 27 | | | |
| 5BT-10-08 | G5/8"X14 | Rc1/2"X14 | 17.5 | 43.5 | 30 | | | |
| 5BT-12-08 | G3/4"X14 | Rc1/2"X14 | 18.5 | 47.5 | 32 | | | |
| 5BT-12 | G3/4"X14 | Rc3/4"X14 | 18.5 | 49 | 36 | | | |
| 5BT-16-12 | G1"X11 | Rc3/4"X14 | 20.5 | 47.5 | 41 | | | |
| 5BT-16 | G1"X11 | Rc1"X11 | 20.5 | 57 | 41 | | | |
| 5BT-20 | G1.1/4"X11 | Rc1.1/4"X11 | 20.5 | 58.5 | 50 | | | |
| 5BT-24 | G1.1/2"X11 | Rc1.1/2"X11 | 23 | 61 | 55 | | | |

英管螺纹60°锥面密封接头 BSP Thread 60° Cone Fittings

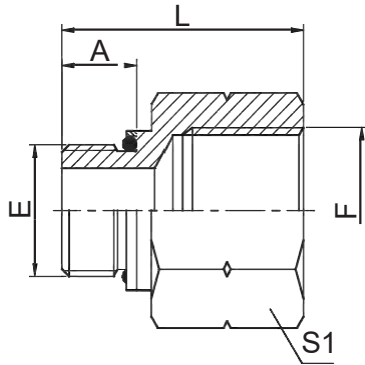

5GB

英管外螺纹O形圈 / 英管内螺纹 ISO 1179
BSP MALE O-RING / BSP FEMALE ISO 1179

| 代号 PART NO. | 螺纹 THREAD | | O形圈 O-RING | | 尺寸 DIMENSIONS | | | | |
|----------------|-----------|----------|------------|--|---------------|------|----|--|--|
| | E | F | E端 | | A | L | S1 | | |
| 5GB-04 | G1/4"X19 | G1/4"X19 | O111 | | 11 | 32 | 19 | | |
| 5GB-04-06 | G1/4"X19 | G3/8"X19 | O111 | | 11 | 35.5 | 22 | | |
| 5GB-06 | G3/8"X19 | G3/8"X19 | O113 | | 11.5 | 36 | 24 | | |
| 5GB-06-08 | G3/8"X19 | G1/2"X14 | O113 | | 11.5 | 41 | 27 | | |
| 5GB-08 | G1/2"X14 | G1/2"X14 | O115 | | 14 | 41 | 27 | | |
| 5GB-08-12 | G1/2"X14 | G3/4"X14 | O115 | | 14 | 44.5 | 36 | | |
| 5GB-12 | G3/4"X14 | G3/4"X14 | O119 | | 15.5 | 44.5 | 36 | | |
| 5GB-12-16 | G3/4"X14 | G1"X11 | O119 | | 15.5 | 50 | 41 | | |
| 5GB-16-12 | G1"X11 | G3/4"X14 | O217 | | 18 | 45.5 | 41 | | |
| 5GB-16 | G1"X11 | G1"X11 | O217 | | 18 | 52.5 | 41 | | |

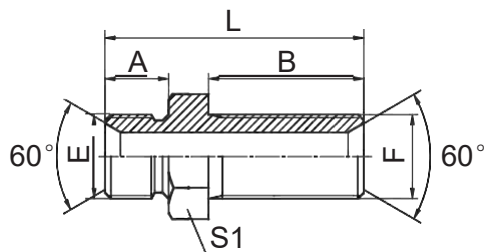

6B

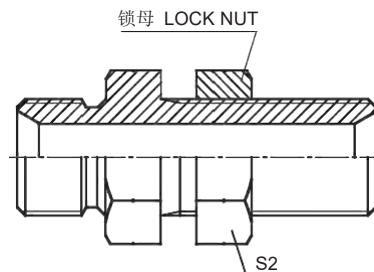

6B-LN

英管外螺纹60°内锥过板接头
BSP MALE 60° SEAT BULKHEAD

| 代号 PART NO. | 螺纹 THREAD | | 尺寸 DIMENSIONS | | | | | | |
|----------------|------------|------------|---------------|--|------|----|------|----|----|
| | E | F | | | A | B | L | S1 | S2 |
| 6B-02 | G1/8"X28 | G1/8"X28 | | | 10 | 33 | 49 | 14 | 14 |
| 6B-04 | G1/4"X19 | G1/4"X19 | | | 12 | 35 | 53 | 19 | 19 |
| 6B-06 | G3/8"X19 | G3/8"X19 | | | 13.5 | 35 | 56.5 | 22 | 22 |
| 6B-08 | G1/2"X14 | G1/2"X14 | | | 16 | 39 | 65 | 27 | 27 |
| 6B-10 | G5/8"X14 | G5/8"X14 | | | 17.5 | 40 | 67.5 | 30 | 30 |
| 6B-12 | G3/4"X14 | G3/4"X14 | | | 18.5 | 42 | 71.5 | 32 | 32 |
| 6B-16 | G1"X11 | G1"X11 | | | 20.5 | 50 | 84 | 41 | 41 |
| 6B-20 | G1.1/4"X11 | G1.1/4"X11 | | | 20.5 | 52 | 89.5 | 50 | 50 |
| 6B-24 | G1.1/2"X11 | G1.1/2"X11 | | | 23 | 55 | 93 | 55 | 55 |
| 6B-32 | G2"X11 | G2"X11 | | | 25.5 | 55 | 97.5 | 70 | 70 |

注：如需带锁母整套订货，则请在代号后加“LN”，如6B-16LN，锁母代号为8B。Note: In case if you are interested to order the adapter in complete set with lock nut ,it is necessary to insert suffix "LN" after our part no.,for example 6B-16LN,The lock nut no. is 8B.

英管螺纹60°锥面密封接头 BSP Thread 60° Cone Fittings

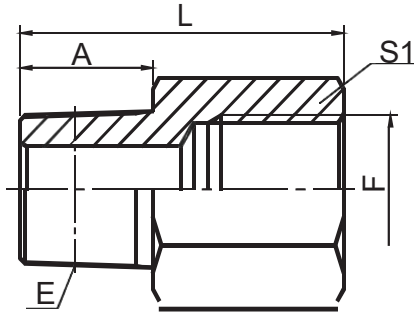

5NB

布锥管外螺纹 / 英管内螺纹
NPT MALE / BSP FEMALE

F

| 代号 PART NO. | 螺纹 THREAD | | 尺寸 DIMENSIONS | | | | | |
|----------------|--------------|------------|---------------|------|----|--|--|--|
| | E | F | A | L | S1 | | | |
| 5NB-02 | Z1/8"X27 | G1/8"X28 | 10.5 | 27 | 14 | | | |
| 5NB-02-04 | Z1/8"X27 | G1/4"X19 | 10.5 | 32 | 19 | | | |
| 5NB-04 | Z1/4"X18 | G1/4"X19 | 15 | 35 | 19 | | | |
| 5NB-04-02 | Z1/4"X18 | G1/8"X28 | 15 | 32 | 17 | | | |
| 5NB-04-06 | Z1/4"X18 | G3/8"X19 | 15 | 37 | 22 | | | |
| 5NB-06 | Z3/8"X18 | G3/8"X19 | 16 | 38 | 22 | | | |
| 5NB-06-04 | Z3/8"X18 | G1/4"X19 | 16 | 30 | 19 | | | |
| 5NB-06-08 | Z3/8"X18 | G1/2"X14 | 16 | 41 | 27 | | | |
| 5NB-08 | Z1/2"X14 | G1/2"X14 | 19.5 | 46 | 27 | | | |
| 5NB-08-04 | Z1/2"X14 | G1/4"X19 | 19.5 | 27.5 | 22 | | | |
| 5NB-08-06 | Z1/2"X14 | G3/8"X19 | 19.5 | 40 | 22 | | | |
| 5NB-08-10 | Z1/2"X14 | G5/8"X14 | 19.5 | 48.5 | 36 | | | |
| 5NB-08-12 | Z1/2"X14 | G3/4"X14 | 19.5 | 48.5 | 32 | | | |
| 5NB-12 | Z3/4"X14 | G3/4"X14 | 19.5 | 48.5 | 36 | | | |
| 5NB-12-04 | Z3/4"X14 | G1/4"X19 | 19.5 | 30 | 30 | | | |
| 5NB-12-06 | Z3/4"X14 | G3/8"X19 | 19.5 | 29.5 | 27 | | | |
| 5NB-12-08 | Z3/4"X14 | G1/2"X14 | 19.5 | 32 | 27 | | | |
| 5NB-12-16 | Z3/4"X14 | G1"X11 | 19.5 | 53 | 41 | | | |
| 5NB-12-20 | Z3/4"X14 | G1.1/4"X11 | 19.5 | 54 | 50 | | | |
| 5NB-16 | Z1"X11.5 | G1"X11 | 25.5 | 59 | 41 | | | |
| 5NB-16-04 | Z1"X11.5 | G1/4"X19 | 25.5 | 37 | 36 | | | |
| 5NB-16-06 | Z1"X11.5 | G3/8"X19 | 25.5 | 37 | 36 | | | |
| 5NB-16-08 | Z1"X11.5 | G1/2"X14 | 25.5 | 37 | 36 | | | |
| 5NB-16-12 | Z1"X11.5 | G3/4"X14 | 25.5 | 37 | 36 | | | |
| 5NB-16-20 | Z1"X11.5 | G1.1/4"X11 | 25.5 | 60 | 50 | | | |
| 5NB-16-24 | Z1"X11.5 | G1.1/2"X11 | 25.5 | 62 | 55 | | | |
| 5NB-20 | Z1.1/4"X11.5 | G1.1/4"X11 | 26.5 | 61 | 50 | | | |
| 5NB-20-16 | Z1.1/4"X11.5 | G1"X11 | 26.5 | 42 | 46 | | | |
| 5NB-20-24 | Z1.1/4"X11.5 | G1.1/2"X11 | 26.5 | 63 | 55 | | | |
| 5NB-20-32 | Z1.1/4"X11.5 | G2"X11 | 26.5 | 67 | 70 | | | |
| 5NB-24 | Z1.1/2"X11.5 | G1.1/2"X11 | 27.5 | 62.5 | 55 | | | |
| 5NB-24-20 | Z1.1/2"X11.5 | G1.1/4"X11 | 27.5 | 58 | 50 | | | |
| 5NB-24-32 | Z1.1/2"X11.5 | G2"X11 | 27.5 | 68 | 70 | | | |
| 5NB-32 | Z2"X11.5 | G2"X11 | 27.5 | 66 | 70 | | | |
| 5NB-32-16 | Z2"X11.5 | G1"X11 | 27.5 | 46 | 65 | | | |
| 5NB-32-20 | Z2"X11.5 | G1.1/4"X11 | 27.5 | 44.5 | 65 | | | |
| 5NB-32-24 | Z2"X11.5 | G1.1/2"X11 | 27.5 | 44.5 | 65 | | | |

英管螺纹60°锥面密封接头 BSP Thread 60° Cone Fittings

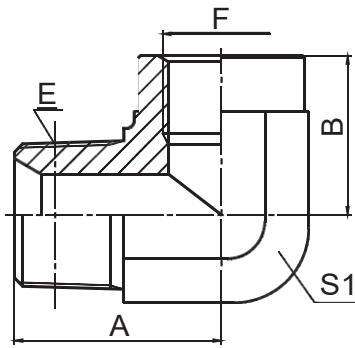

5TB9-SP

90° 英锥管外螺纹/ 英管内螺纹
90° BSPT MALE / BSP FEMALE

| 代号 PART NO. | 螺纹 THREAD | | 尺寸 DIMENSIONS | | | | | |
|----------------|-----------|----------|---------------|----|----|--|--|--|
| | E | F | A | B | S1 | | | |
| 5TB9-02SP | R1/8"X28 | G1/8"X28 | 24.5 | 20 | 16 | | | |
| 5TB9-04SP | R1/4"X19 | G1/4"X19 | 28.5 | 22 | 19 | | | |
| 5TB9-06SP | R3/8"X19 | G3/8"X19 | 33.5 | 26 | 24 | | | |
| 5TB9-08SP | R1/2"X14 | G1/2"X14 | 40.5 | 31 | 30 | | | |
| 5TB9-12SP | R3/4"X14 | G3/4"X14 | 47.5 | 37 | 33 | | | |
| 5TB9-16SP | R1"X11 | G1"X11 | 56.5 | 43 | 41 | | | |

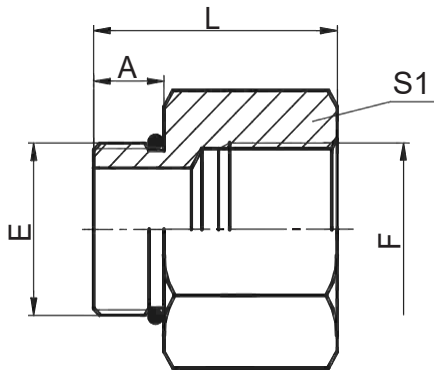

5OB

SAE外螺纹O形圈/ 英管内螺纹
SAE MALE O-RING / BSP FEMALE

| 代号 PART NO. | 螺纹 THREAD | | O形圈 O-RING | 尺寸 DIMENSIONS | | | | |
|----------------|------------|------------|------------|---------------|------|----|--|--|
| | E | F | E端 | A | L | S1 | | |
| 5OB-04 | 7/16"X20 | G1/4"X19 | O904 | 9.1 | 30 | 19 | | |
| 5OB-06-04 | 9/16"X18 | G1/4"X19 | O906 | 9.9 | 30 | 19 | | |
| 5OB-06 | 9/16"X18 | G3/8"X19 | O906 | 9.9 | 33 | 22 | | |
| 5OB-08-06 | 3/4"X16 | G3/8"X19 | O908 | 11.1 | 35 | 24 | | |
| 5OB-08 | 3/4"X16 | G1/2"X14 | O908 | 11.1 | 39 | 27 | | |
| 5OB-10-08 | 7/8"X14 | G1/2"X14 | O910 | 12.7 | 40 | 27 | | |
| 5OB-12-08 | 1.1/16"X12 | G1/2"X14 | O912 | 15.1 | 41.5 | 30 | | |
| 5OB-12 | 1.1/16"X12 | G3/4"X14 | O912 | 15.1 | 44 | 32 | | |
| 5OB-16-12 | 1.5/16"X12 | G3/4"X14 | O916 | 15.1 | 42 | 36 | | |
| 5OB-16 | 1.5/16"X12 | G1"X11 | O916 | 15.1 | 48 | 41 | | |
| 5OB-20 | 1.5/8"X12 | G1.1/4"X11 | O920 | 15.1 | 50 | 50 | | |

英管螺纹60°锥面密封接头 BSP Thread 60° Cone Fittings

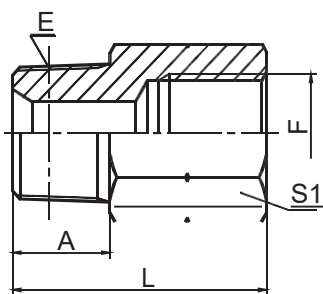

5TB-SP

英锥管外螺纹/ 英管内螺纹
BSPT MALE / BSP FEMALE

| 代号 PART NO. | 螺纹 THREAD | | 尺寸 DIMENSIONS | | | | | |
|----------------|------------|------------|---------------|------|----|--|--|--|
| | E | F | A | L | S1 | | | |
| 5TB-02-04SP | R1/8"X28 | G1/4"X19 | 10 | 31.5 | 19 | | | |
| 5TB-04-06SP | R1/4"X19 | G3/8"X19 | 14.5 | 38.5 | 22 | | | |
| 5TB-04SP | R1/4"X19 | G1/4"X19 | 14.5 | 35 | 19 | | | |
| 5TB-06-04SP | R3/8"X19 | G1/4"X19 | 15 | 36 | 19 | | | |
| 5TB-06-08SP | R3/8"X19 | G1/2"X14 | 15 | 43 | 27 | | | |
| 5TB-06-12SP | R3/8"X19 | G3/4"X14 | 15 | 44 | 36 | | | |
| 5TB-06SP | R3/8"X19 | G3/8"X19 | 15 | 39 | 22 | | | |
| 5TB-08-06SP | R1/2"X14 | G3/8"X19 | 20 | 44 | 22 | | | |
| 5TB-08-12SP | R1/2"X14 | G3/4"X14 | 20 | 50 | 36 | | | |
| 5TB-08-16SP | R1/2"X14 | G1"X11 | 20 | 52 | 41 | | | |
| 5TB-08SP | R1/2"X14 | G1/2"X14 | 20 | 48 | 27 | | | |
| 5TB-12-08SP | R3/4"X14 | G1/2"X14 | 20 | 48 | 30 | | | |
| 5TB-12-16SP | R3/4"X14 | G1"X11 | 20 | 54.5 | 41 | | | |
| 5TB-12SP | R3/4"X14 | G3/4"X14 | 20 | 49 | 36 | | | |
| 5TB-16-12SP | R1"X11 | G3/4"X14 | 25.5 | 55 | 36 | | | |
| 5TB-16-20SP | R1"X11 | G1.1/4"X11 | 25.5 | 61.5 | 50 | | | |
| 5TB-16SP | R1"X11 | G1"X11 | 25.5 | 59 | 41 | | | |
| 5TB-20-08SP | R1.1/4"X11 | G1/2"X14 | 26.5 | 39 | 46 | | | |
| 5TB-20-12SP | R1.1/4"X11 | G3/4"X14 | 26.5 | 39 | 46 | | | |
| 5TB-20-24SP | R1.1/4"X11 | G1.1/2"X11 | 26.5 | 63 | 55 | | | |
| 5TB-20SP | R1.1/4"X11 | G1.1/4"X11 | 26.5 | 61.5 | 50 | | | |
| 5TB-24-16SP | R1.1/2"X11 | G1"X11 | 26.5 | 40.5 | 55 | | | |
| 5TB-24-20SP | R1.1/2"X11 | G1.1/4"X11 | 26.5 | 61 | 55 | | | |
| 5TB-24-32SP | R1.1/2"X11 | G2"X11 | 26.5 | 65 | 70 | | | |
| 5TB-24SP | R1.1/2"X11 | G1.1/2"X11 | 26.5 | 63 | 55 | | | |
| 5TB-32-24SP | R2"X11 | G1.1/2"X11 | 30 | 61 | 65 | | | |

F

英管螺纹60°锥面密封接头 BSP Thread 60° Cone Fittings

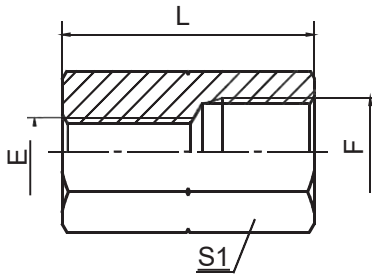

7B

英管内螺纹 ISO 1179
BSP FEMALE ISO 1179

| 代号 PART NO. | 螺 纹 THREAD | | 尺 寸 DIMENSIONS | | | | | | |
|----------------|------------|------------|----------------|--|----|----|--|--|--|
| | E | F | | | L | S1 | | | |
| 7B-02 | G1/8"X28 | G1/8"X28 | | | 22 | 14 | | | |
| 7B-02-04 | G1/8"X28 | G1/4"X19 | | | 24 | 19 | | | |
| 7B-04 | G1/4"X19 | G1/4"X19 | | | 24 | 19 | | | |
| 7B-04-06 | G1/4"X19 | G3/8"X19 | | | 29 | 22 | | | |
| 7B-06 | G3/8"X19 | G3/8"X19 | | | 26 | 22 | | | |
| 7B-06-08 | G3/8"X19 | G1/2"X14 | | | 33 | 27 | | | |
| 7B-08 | G1/2"X14 | G1/2"X14 | | | 32 | 27 | | | |
| 7B-08-10 | G1/2"X14 | G5/8"X14 | | | 36 | 30 | | | |
| 7B-10 | G5/8"X14 | G5/8"X14 | | | 36 | 30 | | | |
| 7B-12 | G3/4"X14 | G3/4"X14 | | | 36 | 32 | | | |
| 7B-12-16 | G3/4"X14 | G1"X11 | | | 43 | 41 | | | |
| 7B-16 | G1"X11 | G1"X11 | | | 40 | 41 | | | |
| 7B-16-20 | G1"X11 | G1.1/4"X11 | | | 46 | 50 | | | |
| 7B-20 | G1.1/4"X11 | G1.1/4"X11 | | | 44 | 50 | | | |
| 7B-20-24 | G1.1/4"X11 | G1.1/2"X11 | | | 48 | 55 | | | |
| 7B-24 | G1.1/2"X11 | G1.1/2"X11 | | | 45 | 55 | | | |
| 7B-24-32 | G1.1/2"X11 | G2"X11 | | | 56 | 70 | | | |
| 7B-32 | G2"X11 | G2"X11 | | | 54 | 70 | | | |

英管螺纹60°锥面密封接头 BSP Thread 60° Cone Fittings

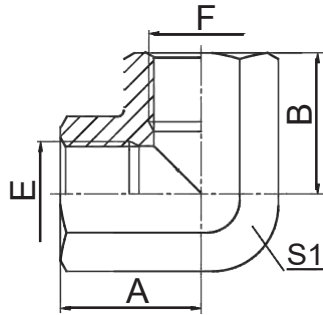

7B9-PK

90° 英管内螺纹 ISO 1179
90° BSP FEMALE ISO 1179

| 代号 PART NO. | 螺纹 THREAD | | 尺寸 DIMENSIONS | | | | |
|----------------|------------|------------|---------------|------|----|--|--|
| | E | F | A | B | S1 | | |
| 7B9-02PK | G1/8"X28 | G1/8"X28 | 20 | 20 | 16 | | |
| 7B9-04PK | G1/4"X19 | G1/4"X19 | 22.5 | 22.5 | 19 | | |
| 7B9-06PK | G3/8"X19 | G3/8"X19 | 26 | 26 | 24 | | |
| 7B9-08PK | G1/2"X14 | G1/2"X14 | 31 | 31 | 27 | | |
| 7B9-12PK | G3/4"X14 | G3/4"X14 | 34 | 34 | 33 | | |
| 7B9-16PK | G1"X11 | G1"X11 | 42 | 42 | 41 | | |
| 7B9-20PK | G1.1/4"X11 | G1.1/4"X11 | 48 | 48 | 50 | | |
| 7B9-24PK | G1.1/2"X11 | G1.1/2"X11 | 53 | 53 | 60 | | |
| 7B9-32PK | G2"X11 | G2"X11 | 62 | 62 | 70 | | |

F

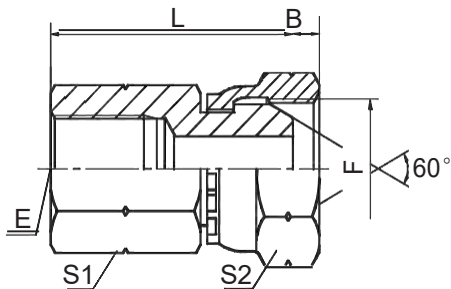

7B-S

英管内螺纹/ 英管内螺纹60° 外锥
BSP FEMALE / BSP FEMALE 60° CONE

| 代号 PART NO. | 螺纹 THREAD | | 尺寸 DIMENSIONS | | | | |
|----------------|------------|------------|---------------|------|----|----|--|
| | E | F | B | L | S1 | S2 | |
| 7B-02S | G1/8"X28 | G1/8"X28 | 3.5 | 29 | 14 | 14 | |
| 7B-04S | G1/4"X19 | G1/4"X19 | 5.5 | 32 | 19 | 19 | |
| 7B-04-06S | G1/4"X19 | G3/8"X19 | 6.3 | 33 | 19 | 22 | |
| 7B-06S | G3/8"X19 | G3/8"X19 | 6.3 | 36.5 | 22 | 22 | |
| 7B-06-04S | G3/8"X19 | G1/4"X19 | 5.5 | 35.5 | 22 | 19 | |
| 7B-06-08S | G3/8"X19 | G1/2"X14 | 7.5 | 37 | 22 | 27 | |
| 7B-08-06S | G1/2"X14 | G3/8"X19 | 6.3 | 41.5 | 27 | 22 | |
| 7B-08S | G1/2"X14 | G1/2"X14 | 7.5 | 42 | 27 | 27 | |
| 7B-08-10S | G1/2"X14 | G5/8"X14 | 9.5 | 43.5 | 27 | 30 | |
| 7B-08-12S | G1/2"X14 | G3/4"X14 | 10.9 | 42 | 27 | 32 | |
| 7B-10-08S | G5/8"X14 | G1/2"X14 | 7.5 | 44 | 30 | 27 | |
| 7B-12-08S | G3/4"X14 | G1/2"X14 | 7.5 | 44 | 32 | 27 | |
| 7B-12S | G3/4"X14 | G3/4"X14 | 10.9 | 45.5 | 32 | 32 | |
| 7B-12-16S | G3/4"X14 | G1"X11 | 11.7 | 47 | 36 | 41 | |
| 7B-16-12S | G1"X11 | G3/4"X14 | 10.9 | 50 | 41 | 32 | |
| 7B-16S | G1"X11 | G1"X11 | 11.7 | 51.5 | 41 | 41 | |
| 7B-20S | G1.1/4"X11 | G1.1/4"X11 | 11 | 55.5 | 50 | 50 | |
| 7B-24S | G1.1/2"X11 | G1.1/2"X11 | 13 | 57.5 | 55 | 55 | |
| 7B-32S | G2"X11 | G2"X11 | 16 | 61 | 70 | 70 | |

英管螺纹60°锥面密封接头 BSP Thread 60° Cone Fittings

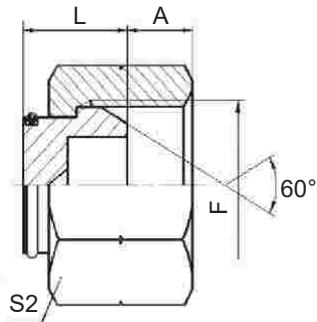

9B

英管内螺纹60°外锥堵头
BSP FEMALE 60° CONE PLUG

| 代号 PART NO. | 螺纹 THREAD | | | 尺寸 DIMENSIONS | | | | |
|----------------|------------|--|--|---------------|------|----|--|--|
| | E | | | A | L | S2 | | |
| 9B-02 | G1/8"X28 | | | 5.5 | 11.5 | 14 | | |
| 9B-04 | G1/4"X19 | | | 5.5 | 13.5 | 19 | | |
| 9B-06 | G3/8"X19 | | | 6.3 | 14.5 | 22 | | |
| 9B-08 | G1/2"X14 | | | 7.5 | 16 | 27 | | |
| 9B-10 | G5/8"X14 | | | 9.5 | 16.5 | 30 | | |
| 9B-12 | G3/4"X14 | | | 10.9 | 17.5 | 32 | | |
| 9B-16 | G1"X11 | | | 11.7 | 19 | 41 | | |
| 9B-20 | G1.1/4"X11 | | | 11 | 21.5 | 50 | | |
| 9B-24 | G1.1/2"X11 | | | 13 | 22 | 55 | | |
| 9B-32 | G2"X11 | | | 16 | 26.5 | 70 | | |

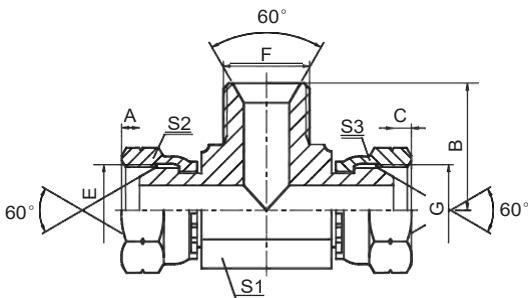

EB

英管内螺纹/ 英管外螺纹/ 英管内螺纹
BSP FEMALE / BSP MALE / BSP FEMALE

| 代号 PART NO. | 螺纹 THREAD | | | 尺寸 DIMENSIONS | | | | |
|----------------|------------|------------|------------|---------------|------|----|----|----|
| | E | F | G | A,C | B | S1 | S2 | S3 |
| EB-02 | G1/8"X28 | G1/8"X28 | G1/8"X28 | 5.5 | 20 | 11 | 14 | 14 |
| EB-04 | G1/4"X19 | G1/4"X19 | G1/4"X19 | 5.5 | 24.5 | 14 | 19 | 19 |
| EB-06 | G3/8"X19 | G3/8"X19 | G3/8"X19 | 6.3 | 27.5 | 16 | 22 | 22 |
| EB-08 | G1/2"X14 | G1/2"X14 | G1/2"X14 | 7.5 | 34.5 | 22 | 27 | 27 |
| EB-10 | G5/8"X14 | G5/8"X14 | G5/8"X14 | 9.5 | 35 | 22 | 30 | 30 |
| EB-12 | G3/4"X14 | G3/4"X14 | G3/4"X14 | 10.9 | 40 | 27 | 32 | 32 |
| EB-16 | G1"X11 | G1"X11 | G1"X11 | 11.7 | 46 | 33 | 41 | 41 |
| EB-20 | G1.1/4"X11 | G1.1/4"X11 | G1.1/4"X11 | 11 | 50.5 | 41 | 50 | 50 |
| EB-24 | G1.1/2"X11 | G1.1/2"X11 | G1.1/2"X11 | 13 | 57.5 | 48 | 55 | 55 |
| EB-32 | G2"X11 | G2"X11 | G2"X11 | 16 | 68 | 63 | 70 | 70 |

英管螺纹60°锥面密封接头 BSP Thread 60° Cone Fittings

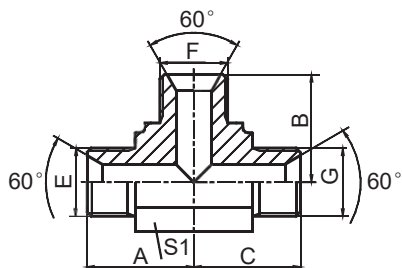

AB

英管外螺纹60°内锥三通
BSP MALE 60° SEAT TEE

F

| 代号 PART NO. | 螺纹 THREAD | | | 尺寸 DIMENSIONS | | | | | |
|----------------|------------|------------|------------|---------------|------|------|----|--|--|
| | E | F | G | A | B | C | S1 | | |
| AB-02 | G1/8"X28 | G1/8"X28 | G1/8"X28 | 19.8 | 19.8 | 19.8 | 11 | | |
| AB-04 | G1/4"X19 | G1/4"X19 | G1/4"X19 | 24.5 | 24.5 | 24.5 | 14 | | |
| AB-04-06-04 | G1/4"X19 | G3/8"X19 | G1/4"X19 | 26.5 | 27.5 | 26.5 | 16 | | |
| AB-06-04-06 | G3/8"X19 | G1/4"X19 | G3/8"X19 | 27.5 | 26.5 | 27.5 | 16 | | |
| AB-06 | G3/8"X19 | G3/8"X19 | G3/8"X19 | 27.5 | 27.5 | 27.5 | 16 | | |
| AB-06-08-06 | G3/8"X19 | G1/2"X14 | G3/8"X19 | 31 | 34.5 | 31 | 22 | | |
| AB-08-06-08 | G1/2"X14 | G3/8"X19 | G1/2"X14 | 34.5 | 31 | 34.5 | 22 | | |
| AB-08 | G1/2"X14 | G1/2"X14 | G1/2"X14 | 34.5 | 34.5 | 34.5 | 22 | | |
| AB-10 | G5/8"X14 | G5/8"X14 | G5/8"X14 | 35 | 35 | 35 | 22 | | |
| AB-12 | G3/4"X14 | G3/4"X14 | G3/4"X14 | 40 | 40 | 40 | 27 | | |
| AB-12-16-12 | G3/4"X14 | G1"X11 | G3/4"X14 | 43.5 | 46 | 43.5 | 33 | | |
| AB-16-12-16 | G1"X11 | G3/4"X14 | G1"X11 | 46 | 43.5 | 46 | 33 | | |
| AB-16 | G1"X11 | G1"X11 | G1"X11 | 46 | 46 | 46 | 33 | | |
| AB-20 | G1.1/4"X11 | G1.1/4"X11 | G1.1/4"X11 | 50.5 | 50.5 | 50.5 | 41 | | |
| AB-24 | G1.1/2"X11 | G1.1/2"X11 | G1.1/2"X11 | 57.5 | 57.5 | 57.5 | 48 | | |
| AB-32 | G2"X11 | G2"X11 | G2"X11 | 72.5 | 72.5 | 72.5 | 63 | | |

英管螺纹60°锥面密封接头 BSP Thread 60° Cone Fittings

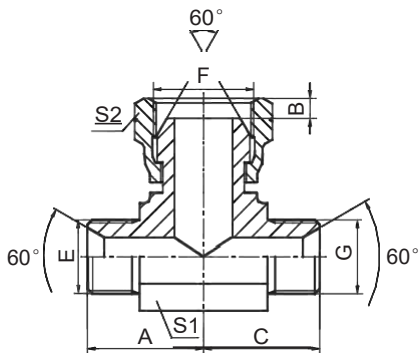

BB

英管外螺纹60°内锥 / 英管内螺纹60°外锥三通
BSP MALE 60° SEAT / BSP FEMALE 60°
CONE BRANCH TEE

| 代号 PART NO. | 螺纹 THREAD | | | 尺寸 DIMENSIONS | | | | | |
|----------------|------------|------------|------------|---------------|------|------|----|----|--|
| | E | F | G | A | B | C | S1 | S2 | |
| BB-02 | G1/8"X28 | G1/8"X28 | G1/8"X28 | 19.8 | 5.5 | 19.8 | 11 | 14 | |
| BB-04 | G1/4"X19 | G1/4"X19 | G1/4"X19 | 24.5 | 5.5 | 24.5 | 14 | 19 | |
| BB-06 | G3/8"X19 | G3/8"X19 | G3/8"X19 | 27.5 | 6.3 | 27.5 | 16 | 22 | |
| BB-08 | G1/2"X14 | G1/2"X14 | G1/2"X14 | 34.5 | 7.5 | 34.5 | 22 | 27 | |
| BB-12 | G3/4"X14 | G3/4"X14 | G3/4"X14 | 40 | 10.9 | 40 | 27 | 32 | |
| BB-16 | G1"X11 | G1"X11 | G1"X11 | 46 | 11.7 | 46 | 33 | 41 | |
| BB-20 | G1.1/4"X11 | G1.1/4"X11 | G1.1/4"X11 | 50.5 | 11 | 50.5 | 41 | 50 | |
| BB-24 | G1.1/2"X11 | G1.1/2"X11 | G1.1/2"X11 | 57.5 | 13 | 57.5 | 48 | 55 | |
| BB-32 | G2"X11 | G2"X11 | G2"X11 | 72.5 | 16 | 72.5 | 63 | 70 | |

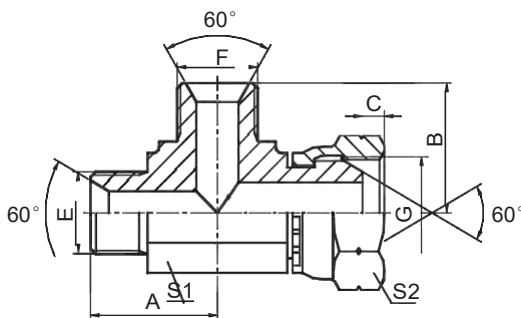

CB

英管外螺纹60°内锥 / 英管
内螺纹60°外锥三通BSP
MALE 60° SEAT / BSP
FEMALE 60° CONE RUN TEE

| 代号 PART NO. | 螺纹 THREAD | | | 尺寸 DIMENSIONS | | | | | |
|----------------|------------|------------|------------|---------------|------|------|----|----|--|
| | E | F | G | A | B | C | S1 | S2 | |
| CB-02 | G1/8"X28 | G1/8"X28 | G1/8"X28 | 19.8 | 19.8 | 5.5 | 11 | 14 | |
| CB-04 | G1/4"X19 | G1/4"X19 | G1/4"X19 | 25 | 25 | 5.5 | 14 | 19 | |
| CB-06 | G3/8"X19 | G3/8"X19 | G3/8"X19 | 27.5 | 27.5 | 6.3 | 16 | 22 | |
| CB-08 | G1/2"X14 | G1/2"X14 | G1/2"X14 | 34.5 | 34.5 | 7.5 | 22 | 27 | |
| CB-10 | G5/8"X14 | G5/8"X14 | G5/8"X14 | 34.5 | 34.5 | 9.5 | 22 | 30 | |
| CB-12 | G3/4"X14 | G3/4"X14 | G3/4"X14 | 40 | 40 | 10.9 | 27 | 32 | |
| CB-16 | G1"X11 | G1"X11 | G1"X11 | 46 | 46 | 11.7 | 33 | 41 | |
| CB-20 | G1.1/4"X11 | G1.1/4"X11 | G1.1/4"X11 | 50.5 | 50.5 | 11 | 41 | 50 | |
| CB-24 | G1.1/2"X11 | G1.1/2"X11 | G1.1/2"X11 | 57.5 | 57.5 | 13 | 48 | 55 | |
| CB-32 | G2"X11 | G2"X11 | G2"X11 | 72.5 | 72.5 | 16 | 63 | 70 | |

英管螺纹60°锥面密封接头 BSP Thread 60° Cone Fittings

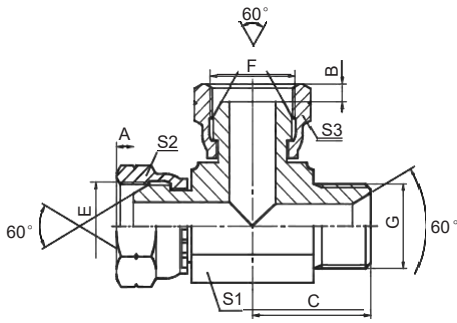

FB

英管内螺纹/ 英管内螺纹/ 英管外螺纹
BSP FEMALE / BSP FEMALE / BSP MALE

| 代号 PART NO. | 螺纹 THREAD | | | 尺寸 DIMENSIONS | | | | | | |
|----------------|------------|------------|------------|---------------|------|------|------|----|----|----|
| | E | F | G | A | B | C | S1 | S2 | S3 | |
| FB-02 | G1/8"X28 | G1/8"X28 | G1/8"X28 | | 5.5 | 5.5 | 20 | 11 | 14 | 14 |
| FB-04 | G1/4"X19 | G1/4"X19 | G1/4"X19 | | 5.5 | 5.5 | 24.5 | 14 | 19 | 19 |
| FB-06 | G3/8"X19 | G3/8"X19 | G3/8"X19 | | 6.3 | 6.3 | 27.5 | 16 | 22 | 22 |
| FB-08 | G1/2"X14 | G1/2"X14 | G1/2"X14 | | 7.5 | 7.5 | 34.5 | 22 | 27 | 27 |
| FB-10 | G5/8"X14 | G5/8"X14 | G5/8"X14 | | 9.5 | 9.5 | 35 | 22 | 30 | 30 |
| FB-12 | G3/4"X14 | G3/4"X14 | G3/4"X14 | | 10.9 | 10.9 | 40 | 27 | 32 | 32 |
| FB-12-08-12 | G3/4"X14 | G1/2"X14 | G3/4"X14 | | 10.9 | 7.5 | 40 | 27 | 32 | 27 |
| FB-16 | G1"X11 | G1"X11 | G1"X11 | | 11.7 | 11.7 | 46 | 33 | 41 | 41 |
| FB-20 | G1.1/4"X11 | G1.1/4"X11 | G1.1/4"X11 | | 11 | 11 | 50.5 | 41 | 50 | 50 |
| FB-24 | G1.1/2"X11 | G1.1/2"X11 | G1.1/2"X11 | | 13 | 13 | 57.5 | 48 | 55 | 55 |
| FB-32 | G2"X11 | G2"X11 | G2"X11 | | 16 | 16 | 72.5 | 63 | 70 | 70 |

F

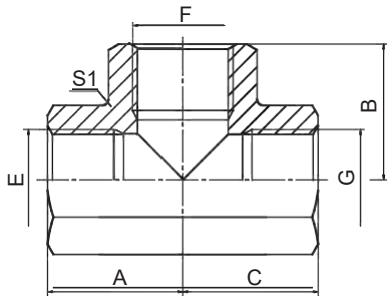

GB-PK

英管内螺纹
BSP FEMALE

| 代号 PART NO. | 螺纹 THREAD | | | 尺寸 DIMENSIONS | | | |
|----------------|------------|------------|------------|---------------|------|------|----|
| | E | F | G | A | B | C | S1 |
| GB-02PK | G1/8"X28 | G1/8"X28 | G1/8"X28 | 20 | 20 | 20 | 16 |
| GB-04PK | G1/4"X19 | G1/4"X19 | G1/4"X19 | 22.5 | 22.5 | 22.5 | 19 |
| GB-06PK | G3/8"X19 | G3/8"X19 | G3/8"X19 | 26 | 26 | 26 | 24 |
| GB-08PK | G1/2"X14 | G1/2"X14 | G1/2"X14 | 31 | 31 | 31 | 27 |
| GB-12PK | G3/4"X14 | G3/4"X14 | G3/4"X14 | 34 | 34 | 34 | 33 |
| GB-16PK | G1"X11 | G1"X11 | G1"X11 | 42 | 42 | 42 | 41 |
| GB-20PK | G1.1/4"X11 | G1.1/4"X11 | G1.1/4"X11 | 48 | 48 | 48 | 50 |
| GB-24PK | G1.1/2"X11 | G1.1/2"X11 | G1.1/2"X11 | 53 | 53 | 53 | 60 |
| GB-32PK | G2"X11 | G2"X11 | G2"X11 | 62 | 62 | 62 | 70 |

型号索引 Part NO. Index

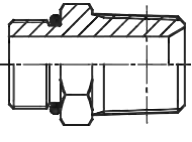
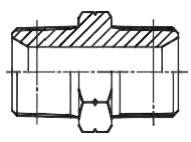
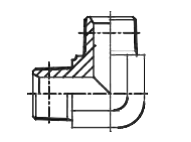
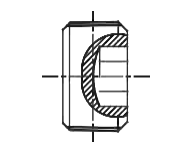
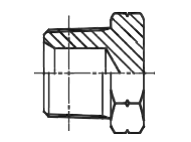
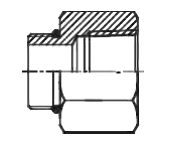
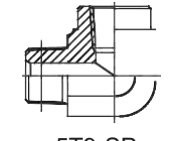
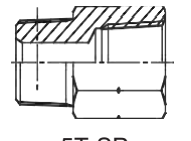
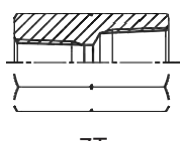
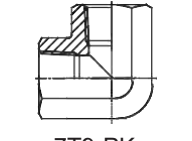
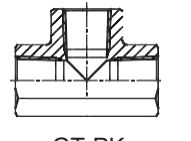
| | | | | | |
|---|--|---|--|--|--|
|  <p>10T-SP PG1</p> |  <p>1T-SP PG1</p> |  <p>1T9-SP PG2</p> |  <p>4TN-GM PG3</p> |  <p>4T-SP PG3</p> |  <p>5OT PG4</p> |
|  <p>5T9-SP PG4</p> |  <p>5T-SP PG5</p> |  <p>7T PG6</p> |  <p>7T9-PK PG7</p> |  <p>GT-PK PG7</p> | |
| | | | | | |
| | | | | | |
| | | | | | |
| | | | | | |
| | | | | | |

英锥管螺纹BSPT接头 BSPT Thread Fittings

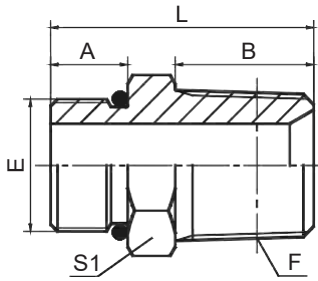

1OT-SP

SAE外螺纹带O形圈 / 英锥管外螺纹
SAE O-RING BOSS / BSPT MALE

| 代号 PART NO. | 螺 纹 THREAD | | O 形圈 O-RING | | 尺 寸 DIMENSIONS | | | | |
|----------------|------------|----------|-------------|--|----------------|------|------|----|--|
| | E | F | E端 | | A | B | L | S1 | |
| 1OT-04SP | 7/16"X20 | R1/4"X19 | O904 | | 9.14 | 14.5 | 29.5 | 17 | |
| 1OT-06SP | 9/16"X18 | R3/8"X19 | O906 | | 9.93 | 15 | 30.5 | 19 | |
| 1OT-06-04SP | 9/16"X18 | R1/4"X19 | O906 | | 9.93 | 14.5 | 30 | 19 | |
| 1OT-08-04SP | 3/4"X16 | R1/4"X19 | O908 | | 11.13 | 14.5 | 33.5 | 22 | |
| 1OT-08-06SP | 3/4"X16 | R3/8"X19 | O908 | | 11.13 | 15 | 34 | 22 | |
| 1OT-08SP | 3/4"X16 | R1/2"X14 | O908 | | 11.13 | 20 | 38 | 22 | |
| 1OT-10-06SP | 7/8"X14 | R3/8"X19 | O910 | | 12.7 | 15 | 37.5 | 27 | |
| 1OT-10-08SP | 7/8"X14 | R1/2"X14 | O910 | | 12.7 | 20 | 42.5 | 27 | |
| 1OT-12-08SP | 1.1/16"X12 | R1/2"X14 | O912 | | 15.09 | 20 | 46 | 32 | |
| 1OT-12SP | 1.1/16"X12 | R3/4"X14 | O912 | | 15.09 | 20 | 46 | 32 | |
| 1OT-16-12SP | 1.5/16"X12 | R3/4"X14 | O916 | | 15.09 | 20 | 46 | 38 | |
| 1OT-16SP | 1.5/16"X12 | R1"X11 | O916 | | 15.09 | 25.5 | 51 | 38 | |
| 1OT-20-16SP | 1.5/8"X12 | R1"X11 | O920 | | 15.09 | 25.5 | 55.5 | 50 | |

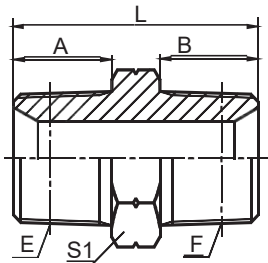

1T-SP

英锥管外螺纹
BSPT MALE

| 代号 PART NO. | 螺 纹 THREAD | | 尺 寸 DIMENSIONS | | | | | | |
|----------------|------------|------------|----------------|--|------|------|------|----|--|
| | E | F | | | A | B | L | S1 | |
| 1T-02SP | R1/8"X28 | R1/8"X28 | | | 10 | 10 | 26 | 12 | |
| 1T-02-04SP | R1/8"X28 | R1/4"X19 | | | 10 | 14.5 | 30.5 | 14 | |
| 1T-02-06SP | R1/8"X28 | R3/8"X19 | | | 10 | 15 | 31 | 17 | |
| 1T-04SP | R1/4"X19 | R1/4"X19 | | | 14.5 | 14.5 | 34 | 14 | |
| 1T-04-06SP | R1/4"X19 | R3/8"X19 | | | 14.5 | 15 | 35 | 17 | |
| 1T-04-08SP | R1/4"X19 | R1/2"X14 | | | 15 | 20 | 43 | 22 | |
| 1T-06SP | R3/8"X19 | R3/8"X19 | | | 15 | 15 | 36 | 17 | |
| 1T-06-08SP | R3/8"X19 | R1/2"X14 | | | 15 | 20 | 43 | 22 | |
| 1T-08SP | R1/2"X14 | R1/2"X14 | | | 20 | 20 | 46 | 22 | |
| 1T-08-12SP | R1/2"X14 | R3/4"X14 | | | 20 | 20 | 48 | 27 | |
| 1T-12SP | R3/4"X14 | R3/4"X14 | | | 20 | 20 | 48 | 27 | |
| 1T-12-16SP | R3/4"X14 | R1"X11 | | | 20 | 25.5 | 55.5 | 36 | |
| 1T-16SP | R1"X11 | R1"X11 | | | 25.5 | 25.5 | 61 | 36 | |
| 1T-16-20SP | R1"X11 | R1.1/4"X11 | | | 25.5 | 26.5 | 64.5 | 46 | |
| 1T-20SP | R1.1/4"X11 | R1.1/4"X11 | | | 26.5 | 26.5 | 65.5 | 46 | |
| 1T-20-24SP | R1.1/4"X11 | R1.1/2"X11 | | | 26.5 | 26.5 | 67 | 50 | |
| 1T-24SP | R1.1/2"X11 | R1.1/2"X11 | | | 26.5 | 26.5 | 67 | 50 | |
| 1T-24-32SP | R1.1/2"X11 | R2"X11 | | | 26.5 | 30 | 71.5 | 65 | |
| 1T-32SP | R2"X11 | R2"X11 | | | 30 | 30 | 75 | 65 | |

G

英锥管螺纹BSPT接头 BSPT Thread Fittings

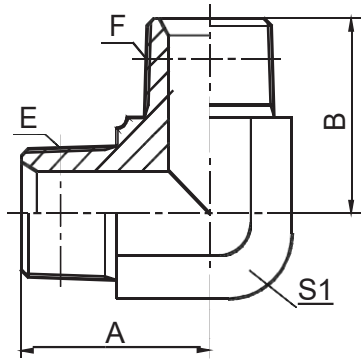

1T9-SP

90° 弯英锥管外螺纹
90° ELBOW BSPT MALE

| 代号 PART NO. | 螺纹 THREAD | | 尺寸 DIMENSIONS | | | | | | |
|----------------|------------|------------|---------------|--|------|------|----|--|--|
| | E | F | | | A | B | S1 | | |
| 1T9-02SP | R1/8"X28 | R1/8"X28 | | | 21 | 21 | 11 | | |
| 1T9-02-04SP | R1/8"X28 | R1/4"X19 | | | 23.5 | 25.5 | 14 | | |
| 1T9-04SP | R1/4"X19 | R1/4"X19 | | | 25.5 | 25.5 | 14 | | |
| 1T9-04-06SP | R1/4"X19 | R3/8"X19 | | | 26.5 | 28.5 | 16 | | |
| 1T9-04-08SP | R1/4"X19 | R1/2"X14 | | | 30.5 | 36 | 22 | | |
| 1T9-06SP | R3/8"X19 | R3/8"X19 | | | 28.5 | 28.5 | 16 | | |
| 1T9-06-08SP | R3/8"X19 | R1/2"X14 | | | 32.5 | 36 | 22 | | |
| 1T9-08SP | R1/2"X14 | R1/2"X14 | | | 36 | 36 | 22 | | |
| 1T9-08-12SP | R1/2"X14 | R3/4"X14 | | | 39.5 | 43.5 | 27 | | |
| 1T9-12SP | R3/4"X14 | R3/4"X14 | | | 43.5 | 43.5 | 27 | | |
| 1T9-12-16SP | R3/4"X14 | R1"X11 | | | 48 | 50 | 33 | | |
| 1T9-16SP | R1"X11 | R1"X11 | | | 50 | 50 | 33 | | |
| 1T9-16-20SP | R1"X11 | R1.1/4"X11 | | | 56.5 | 57.5 | 41 | | |
| 1T9-20SP | R1.1/4"X11 | R1.1/4"X11 | | | 56.5 | 56.5 | 41 | | |
| 1T9-24SP | R1.1/2"X11 | R1.1/2"X11 | | | 62.5 | 62.5 | 48 | | |
| 1T9-32SP | R2"X11 | R2"X11 | | | 68 | 75 | 63 | | |

英锥管螺纹BSPT接头 BSPT Thread Fittings

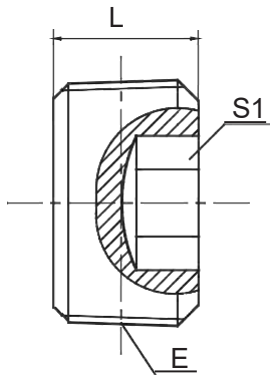

4TN-GM

英锥管外螺纹内六角堵头
BSPT MALE HOLLOW HEX PLUG

| 代号 PART NO. | 螺 纹 THREAD | | | 尺 寸 DIMENSIONS | | | | |
|----------------|------------|--|--|----------------|----|--|--|--|
| | E | | | L | S1 | | | |
| 4TN-02GM | R1/8"X28 | | | 8 | 5 | | | |
| 4TN-04GM | R1/4"X19 | | | 9 | 6 | | | |
| 4TN-06GM | R3/8"X19 | | | 10 | 8 | | | |
| 4TN-08GM | R1/2"X14 | | | 12 | 10 | | | |
| 4TN-12GM | R3/4"X14 | | | 12 | 12 | | | |
| 4TN-16GM | R1"X11 | | | 17 | 17 | | | |

G

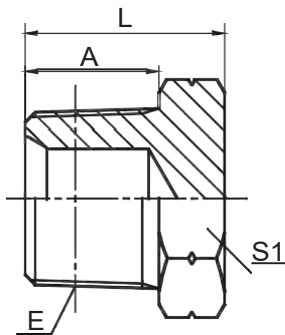

4T-SP

英锥管外螺纹堵头
BSPT MALE PLUG

| 代号 PART NO. | 螺 纹 THREAD | | | 尺 寸 DIMENSIONS | | | | |
|----------------|------------|--|--|----------------|------|----|--|--|
| | E | | | A | L | S1 | | |
| 4T-02SP | R1/8"X28 | | | 10 | 16 | 12 | | |
| 4T-04SP | R1/4"X19 | | | 14.5 | 20 | 14 | | |
| 4T-06SP | R3/8"X19 | | | 15 | 21 | 17 | | |
| 4T-08SP | R1/2"X14 | | | 20 | 27 | 22 | | |
| 4T-12SP | R3/4"X14 | | | 20 | 29 | 27 | | |
| 4T-16SP | R1"X11 | | | 25.5 | 36.5 | 36 | | |
| 4T-20SP | R1.1/4"X11 | | | 26.5 | 38.5 | 46 | | |
| 4T-24SP | R1.1/2"X11 | | | 26.5 | 42 | 50 | | |
| 4T-32SP | R2"X11 | | | 30 | 47 | 65 | | |

英锥管螺纹BSPT接头 BSPT Thread Fittings

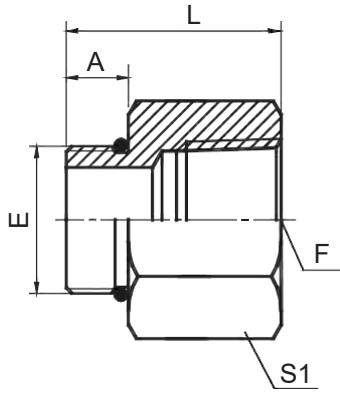

50T

SAE外螺纹带O形圈/ 英锥管内螺纹
SAE O-RING BOSS / BSPT FEMALE

| 代号 PART NO. | 螺 纹 THREAD | | O 形圈 O-RING | | 尺 寸 DIMENSIONS | | | |
|----------------|------------|-----------|-------------|--|----------------|------|----|--|
| | E | F | E端 | | A | L | S1 | |
| 50T-04 | 7/16"X20 | Rc1/4"X19 | O904 | | 9.1 | 30.5 | 19 | |
| 50T-04-02 | 7/16"X20 | Rc1/8"X28 | O904 | | 9.1 | 26 | 17 | |
| 50T-06 | 9/16"X18 | Rc3/8"X19 | O906 | | 9.9 | 32.5 | 22 | |
| 50T-06-04 | 9/16"X18 | Rc1/4"X19 | O906 | | 9.9 | 31.5 | 19 | |
| 50T-08 | 3/4"X16 | Rc1/2"X14 | O908 | | 11.1 | 40 | 30 | |
| 50T-08-02 | 3/4"X16 | Rc1/8"X28 | O908 | | 11.1 | 22 | 22 | |
| 50T-08-04 | 3/4"X16 | Rc1/4"X19 | O908 | | 11.1 | 32.5 | 22 | |
| 50T-08-06 | 3/4"X16 | Rc3/8"X19 | O908 | | 11.1 | 34 | 22 | |
| 50T-10-06 | 7/8"X14 | Rc3/8"X19 | O910 | | 12.7 | 35.5 | 27 | |
| 50T-10-08 | 7/8"X14 | Rc1/2"X14 | O910 | | 12.7 | 41.5 | 30 | |
| 50T-12-06 | 1.1/16"X12 | Rc3/8"X19 | O912 | | 15.1 | 30.5 | 32 | |
| 50T-12-08 | 1.1/16"X12 | Rc1/2"X14 | O912 | | 15.1 | 42 | 32 | |
| 50T-16 | 1.5/16"X12 | Rc1"X11 | O916 | | 15.1 | 51.5 | 41 | |
| 50T-16-08 | 1.5/16"X12 | Rc1/2"X14 | O916 | | 15.1 | 42 | 38 | |
| 50T-16-12 | 1.5/16"X12 | Rc3/4"X14 | O916 | | 15.1 | 43 | 38 | |

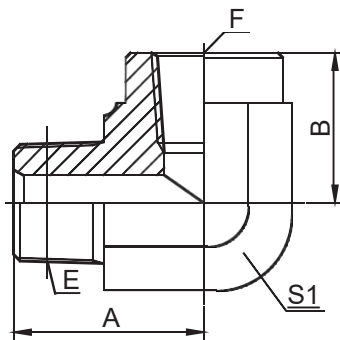

5T9-SP

90° 弯英锥管外螺纹/ 英锥管内螺纹
90° ELBOW BSPT MALE / BSPT FEMALE

| 代号 PART NO. | 螺 纹 THREAD | | 尺 寸 DIMENSIONS | | | |
|----------------|------------|-------------|----------------|------|----|--|
| | E | F | A | B | S1 | |
| 5T9-02SP | R1/8"X28 | Rc1/8"X28 | 24.5 | 23 | 16 | |
| 5T9-04SP | R1/4"X19 | Rc1/4"X19 | 28.5 | 25 | 19 | |
| 5T9-06SP | R3/8"X19 | Rc3/8"X19 | 33.5 | 25 | 24 | |
| 5T9-08SP | R1/2"X14 | Rc1/2"X14 | 40.8 | 31.5 | 30 | |
| 5T9-12SP | R3/4"X14 | Rc3/4"X14 | 47.5 | 37 | 33 | |
| 5T9-16SP | R1"X11 | Rc1"X11 | 56.5 | 43 | 41 | |
| 5T9-20SP | R1.1/4"X11 | Rc1.1/4"X11 | 61 | 50 | 48 | |
| 5T9-24SP | R1.1/2"X11 | Rc1.1/2"X11 | 75 | 55 | 63 | |

英锥管螺纹BSPT接头 BSPT Thread Fittings

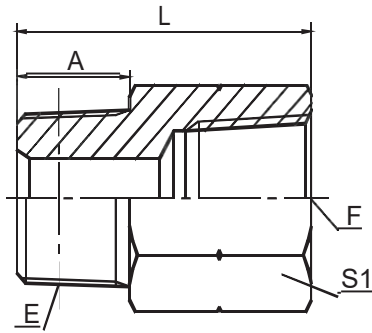

5T-SP

英锥管外螺纹 / 英锥管内螺纹
BSPT MALE / BSPT FEMALE

| 代号 PART NO. | 螺纹 THREAD | | 尺寸 DIMENSIONS | | | | |
|----------------|------------|-------------|---------------|------|----|--|--|
| | E | F | A | L | S1 | | |
| 5T-02-04SP | R1/8"X28 | Rc1/4"X19 | 11 | 32.5 | 19 | | |
| 5T-04-02SP | R1/4"X19 | Rc1/8"X28 | 14.5 | 20.5 | 14 | | |
| 5T-04SP | R1/4"X19 | Rc1/4"X19 | 14.5 | 36 | 19 | | |
| 5T-04-06SP | R1/4"X19 | Rc3/8"X19 | 14.5 | 38 | 22 | | |
| 5T-06-02SP | R3/8"X19 | Rc1/8"X28 | 15 | 23 | 19 | | |
| 5T-06-04SP | R3/8"X19 | Rc1/4"X19 | 15 | 23 | 19 | | |
| 5T-06SP | R3/8"X19 | Rc3/8"X19 | 15 | 38.5 | 22 | | |
| 5T-06-08SP | R3/8"X19 | Rc1/2"X14 | 15 | 44 | 27 | | |
| 5T-08-04SP | R1/2"X14 | Rc1/4"X19 | 20 | 30 | 24 | | |
| 5T-08-06SP | R1/2"X14 | Rc3/8"X19 | 20 | 30 | 24 | | |
| 5T-08SP | R1/2"X14 | Rc1/2"X14 | 20 | 49 | 27 | | |
| 5T-08-12SP | R1/2"X14 | Rc3/4"X14 | 20 | 51 | 36 | | |
| 5T-12-06SP | R3/4"X14 | Rc3/8"X19 | 20 | 31 | 30 | | |
| 5T-12-08SP | R3/4"X14 | Rc1/2"X14 | 20 | 31 | 30 | | |
| 5T-12SP | R3/4"X14 | Rc3/4"X14 | 20 | 51 | 36 | | |
| 5T-12-16SP | R3/4"X14 | Rc1"X11 | 20 | 56.5 | 41 | | |
| 5T-16-08SP | R1"X11 | Rc1/2"X14 | 25.5 | 37 | 36 | | |
| 5T-16-12SP | R1"X11 | Rc3/4"X14 | 25.5 | 37 | 36 | | |
| 5T-16SP | R1"X11 | Rc1"X11 | 25.5 | 59 | 41 | | |
| 5T-16-20SP | R1"X11 | Rc1.1/4"X11 | 25.5 | 64 | 50 | | |
| 5T-20-12SP | R1.1/4"X11 | Rc3/4"X14 | 26.5 | 38 | 46 | | |
| 5T-20-16SP | R1.1/4"X11 | Rc1"X11 | 26.5 | 38 | 46 | | |
| 5T-20SP | R1.1/4"X11 | Rc1.1/4"X11 | 26.5 | 64 | 50 | | |
| 5T-24-16SP | R1.1/2"X11 | Rc1"X11 | 26.5 | 41 | 50 | | |
| 5T-24-20SP | R1.1/2"X11 | Rc1.1/4"X11 | 26.5 | 41 | 50 | | |
| 5T-32-20SP | R2"X11 | Rc1.1/4"X11 | 30 | 45 | 65 | | |
| 5T-32-24SP | R2"X11 | Rc1.1/2"X11 | 30 | 45 | 65 | | |

G

英锥管螺纹BSPT接头 BSPT Thread Fittings

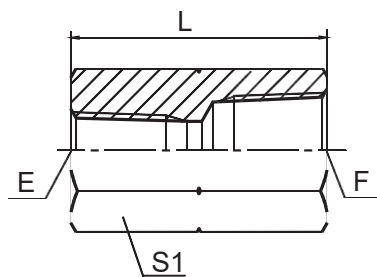

7T

英锥管内螺纹
BSPT FEMALE

| 代号 PART NO. | 螺 纹 THREAD | | 尺 寸 DIMENSIONS | | | | | | |
|----------------|-------------|-------------|----------------|--|----|----|--|--|--|
| | E | F | | | L | S1 | | | |
| 7T-02 | Rc1/8"X28 | Rc1/8"X28 | | | 20 | 14 | | | |
| 7T-02-04 | Rc1/8"X28 | Rc1/4"X19 | | | 30 | 19 | | | |
| 7T-04 | Rc1/4"X19 | Rc1/4"X19 | | | 30 | 19 | | | |
| 7T-04-06 | Rc1/4"X19 | Rc3/8"X19 | | | 30 | 22 | | | |
| 7T-04-08 | Rc1/4"X19 | Rc1/2"X14 | | | 40 | 27 | | | |
| 7T-06 | Rc3/8"X19 | Rc3/8"X19 | | | 30 | 22 | | | |
| 7T-06-08 | Rc3/8"X19 | Rc1/2"X14 | | | 40 | 27 | | | |
| 7T-06-12 | Rc3/8"X19 | Rc3/4"X14 | | | 37 | 36 | | | |
| 7T-08 | Rc1/2"X14 | Rc1/2"X14 | | | 40 | 27 | | | |
| 7T-08-12 | Rc1/2"X14 | Rc3/4"X14 | | | 42 | 36 | | | |
| 7T-12 | Rc3/4"X14 | Rc3/4"X14 | | | 42 | 36 | | | |
| 7T-12-16 | Rc3/4"X14 | Rc1"X11 | | | 50 | 41 | | | |
| 7T-16 | Rc1"X11 | Rc1"X11 | | | 50 | 41 | | | |
| 7T-16-20 | Rc1"X11 | Rc1.1/4"X11 | | | 52 | 50 | | | |
| 7T-20 | Rc1.1/4"X11 | Rc1.1/4"X11 | | | 55 | 50 | | | |
| 7T-24 | Rc1.1/2"X11 | Rc1.1/2"X11 | | | 55 | 55 | | | |
| 7T-32 | Rc2"X11 | Rc2"X11 | | | 65 | 70 | | | |

英锥管螺纹BSPT接头 BSPT Thread Fittings

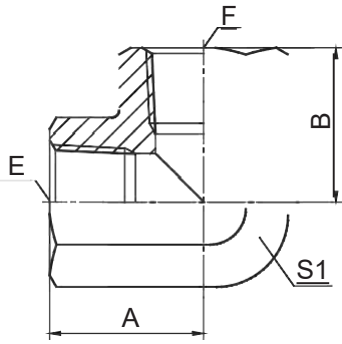

7T9-PK

90° 弯英锥管内螺纹
90° ELBOW BSPT FEMALE

| 代号 PART NO. | 螺 纹 THREAD | | 尺 寸 DIMENSIONS | | | | |
|----------------|-------------|-------------|----------------|------|----|--|--|
| | E | F | A | B | S1 | | |
| 7T9-02PK | Rc1/8"X28 | Rc1/8"X28 | 20 | 20 | 16 | | |
| 7T9-02-04PK | Rc1/8"X28 | Rc1/4"X19 | 20 | 22.5 | 19 | | |
| 7T9-04PK | Rc1/4"X19 | Rc1/4"X19 | 22.5 | 22.5 | 19 | | |
| 7T9-06PK | Rc3/8"X19 | Rc3/8"X19 | 26 | 26 | 24 | | |
| 7T9-08PK | Rc1/2"X14 | Rc1/2"X14 | 31 | 31 | 27 | | |
| 7T9-12PK | Rc3/4"X14 | Rc3/4"X14 | 34 | 34 | 33 | | |
| 7T9-16PK | Rc1"X11 | Rc1"X11 | 42 | 42 | 41 | | |
| 7T9-20PK | Rc1.1/4"X11 | Rc1.1/4"X11 | 48 | 48 | 50 | | |
| 7T9-24PK | Rc1.1/2"X11 | Rc1.1/2"X11 | 53 | 53 | 60 | | |
| 7T9-32PK | Rc2"X11 | Rc2"X11 | 62 | 62 | 70 | | |

G

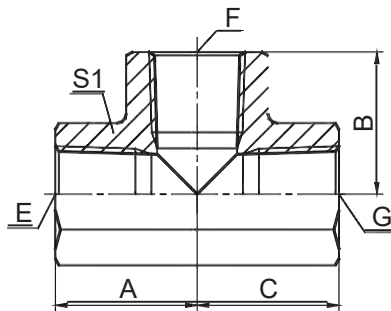

GT-PK

英锥管内螺纹三通
BSPT FEMALE TEE

| 代号 PART NO. | 螺 纹 THREAD | | | 尺 寸 DIMENSIONS | | | | |
|----------------|-------------|-------------|-------------|----------------|------|------|----|--|
| | E | F | G | A | B | C | S1 | |
| GT-02PK | Rc1/8"X28 | Rc1/8"X28 | Rc1/8"X28 | 20 | 20 | 20 | 16 | |
| GT-04PK | Rc1/4"X19 | Rc1/4"X19 | Rc1/4"X19 | 22.5 | 22.5 | 22.5 | 19 | |
| GT-06PK | Rc3/8"X19 | Rc3/8"X19 | Rc3/8"X19 | 26 | 26 | 26 | 24 | |
| GT-08PK | Rc1/2"X14 | Rc1/2"X14 | Rc1/2"X14 | 31 | 31 | 31 | 27 | |
| GT-12PK | Rc3/4"X14 | Rc3/4"X14 | Rc3/4"X14 | 34 | 34 | 34 | 33 | |
| GT-16PK | Rc1"X11 | Rc1"X11 | Rc1"X11 | 42 | 42 | 42 | 41 | |
| GT-20PK | Rc1.1/4"X11 | Rc1.1/4"X11 | Rc1.1/4"X11 | 48 | 48 | 48 | 50 | |
| GT-24PK | Rc1.1/2"X11 | Rc1.1/2"X11 | Rc1.1/2"X11 | 53 | 53 | 53 | 60 | |
| GT-32K | Rc2"X11 | Rc2"X11 | Rc2"X11 | 62 | 62 | 62 | 70 | |

美制螺纹接头

American Thread Fittings

美制螺纹JIC 74° 锥面扩口接头
JIC 74° Cone Flared Tube Fittings

H

美制螺纹O型圈平面密封接头
ORFS Fittings

I

美制锥管螺纹NPT接头
NPT Thread Fittings

J

美制螺纹NPSM接头
NPSM Fittings







K

美制SAE外螺纹90° 外锥接头
SAE Male 90° Cone Fittings

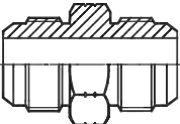
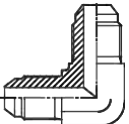
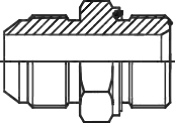
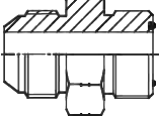
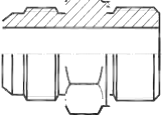
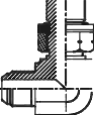
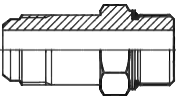
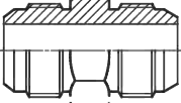
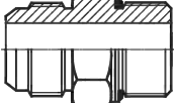
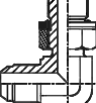
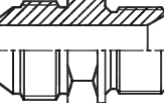
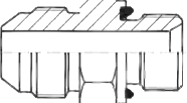
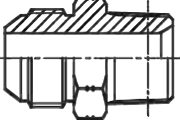
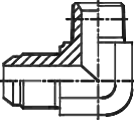
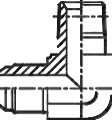
L



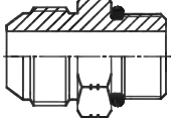
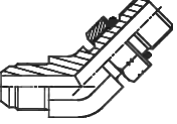
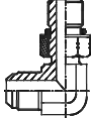
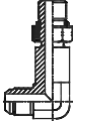
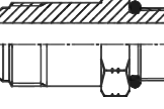
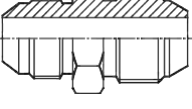
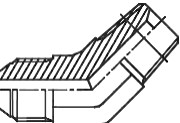
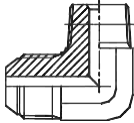
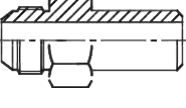
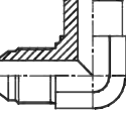
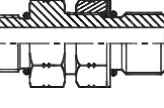
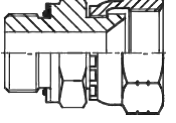
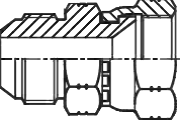
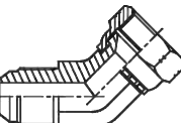
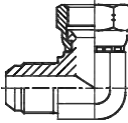
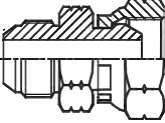
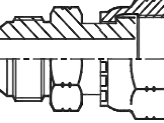
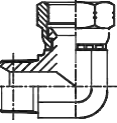
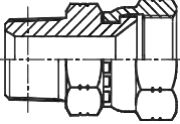
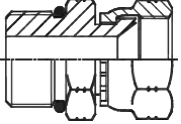
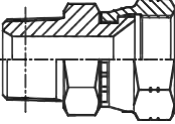

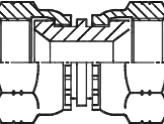
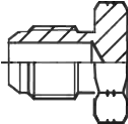
美制螺纹JIC 74° 锥面扩口接头 JIC 74° Cone Flared Tube Fittings

型号索引 Part NO. Index

| | | | | | |
|--|--|--|--|--|---|
|  1J PH1 |  1J9 PH2 |  1JB-WD PH3 |  1JF PH4 |  1JG PH5 |  1JG9-OG PH6 |
|  1JG-L PH7 |  1JK PH7 |  1JH PH8 |  1JH9-OG PH9 |  1JM PH10 |  1JM-WD PH11 |
|  1JN PH12 |  1JN9 PH13 |  1JN9-L PH14 |  1JN9-LL PH14 |  1JN-L PH15 |  1JN-LL PH15 |
|  1JO PH16 |  1JO4-OG PH17 |  1JO9-OG PH18 |  1JO9-OG/L PH19 |  1JO-L PH19 |  1JS PH20 |
|  1JT4-SP PH21 |  1JT9-SP PH22 |  1JW PH23 |  1JW9-IN PH23 |  1O-OG PH24 |  2GJ PH24 |
|  2J PH25 |  2J4 PH26 |  2J9 PH27 |  2JB PH28 |  2JF PH29 |  2NJ9 PH29 |
|  2NJ PH30 |  2OJ PH31 |  2TJ-SP PH32 |  4ON PH32 |  3J PH33 |  4J PH34 |

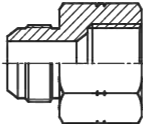

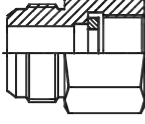
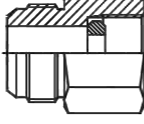
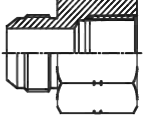
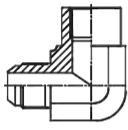
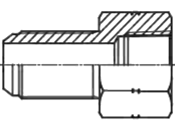
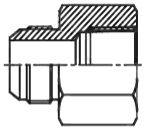
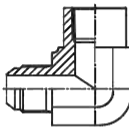
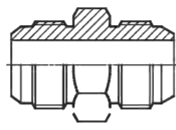
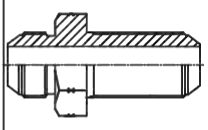
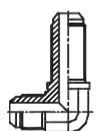
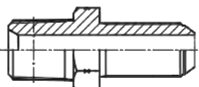
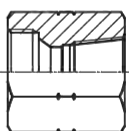
美制螺纹JIC 74° 锥面扩口接头 JIC 74° Cone Flared Tube Fittings

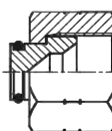
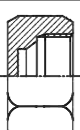
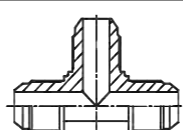
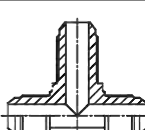
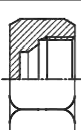
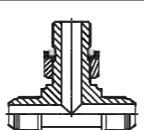
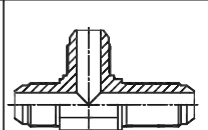
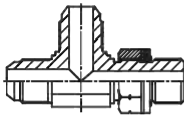
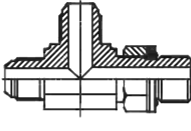
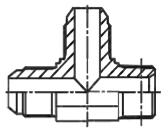
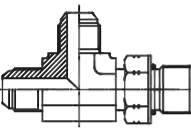
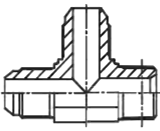
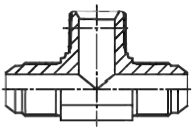
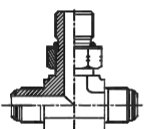
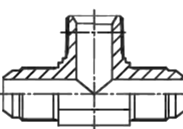
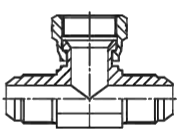
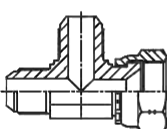
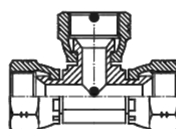
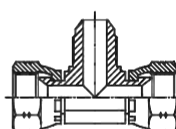
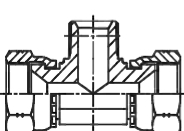
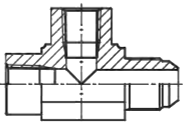
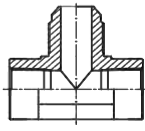
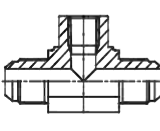
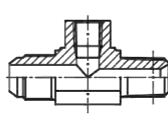
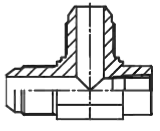
型号索引 Part NO. Index

| | | | | | |
|--|--|--|--|--|--|
|  4O PH34 |  5J PH35 |  5JB PH36 |  5JB-G PH37 |  5JB-GDK PH37 |  5JN PH38 |
|  5JN9 PH38 |  5JN-BH PH39 |  5JT PH40 |  5JT9 PH40 |  5O PH41 |  6J PH42 |
|  6J9 PH43 |  6NJ PH44 |  7JN PH44 |  8J PH45 |  8J-OG PH45 |  9J PH46 |
|  9J-CAP PH46 |  AJ PH47 |  AJ6JJ PH48 |  AJGJ-OG PH48 |  AJHJ-OG PH49 |  AJJ6J PH50 |
|  AJJG-OG PH50 |  AJJH-OG PH51 |  AJJN PH52 |  AJJO-OG PH53 |  AJJT-SP PH54 |  AJNJ PH54 |
|  AJOJ-OG PH55 |  AJTJ-SP PH56 |  BJ PH56 |  CJ PH57 |  DJ PH57 |  EJ PH58 |
|  EJNJ PH58 |  HNNJ PH59 |  JNJN PH59 |  KJNJ PH60 |  KJNN PH60 |  LJNJ PH61 |

美制螺纹JIC 74° 锥面扩口接头 JIC 74° Cone Flared Tube Fittings

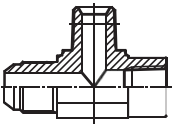
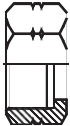
型号索引 Part NO. Index

|  <p>LJNN PH62</p> |  <p>NB200 PH62</p> |  <p>NB300 PH63</p> |  <p>NB500 PH63</p> | | |
|--|---|---|---|--|--|
| | | | | | |
| | | | | | |
| | | | | | |
| | | | | | |
| | | | | | |
| | | | | | |
| | | | | | |

美制螺纹JIC 74° 锥面扩口接头 JIC 74° Cone Flared Tube Fittings

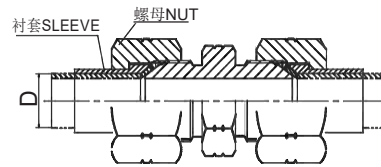
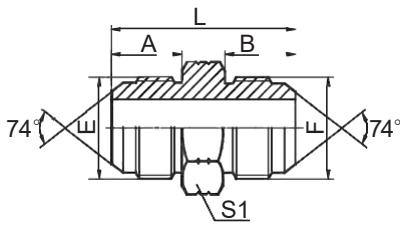

美制JIC外螺纹74° 外锥
JIC MALE 74° CONE

1J

| 代号 PART NO. | 螺 纹 THREAD | | 尺 寸 DIMENSIONS | | | | |
|----------------|-------------|-------------|----------------|------|------|----|--|
| | E | F | A | B | L | S1 | |
| 1J-02 | 5/16"X 24 | 5/16"X 24 | 11.4 | 11.4 | 29 | 12 | |
| 1J-02-03 | 5/16"X 24 | 3/8"X 24 | 11.4 | 12.2 | 29.5 | 12 | |
| 1J-03 | 3/8"X 24 | 3/8"X 24 | 12.2 | 12.2 | 30.5 | 12 | |
| 1J-04 | 7/16"X 20 | 7/16"X 20 | 14 | 14 | 34 | 12 | |
| 1J-04-05 | 7/16"X 20 | 1/2"X 20 | 14 | 14 | 34 | 14 | |
| 1J-04-06 | 7/16"X 20 | 9/16"X 18 | 14 | 14.1 | 34.1 | 17 | |
| 1J-04-08 | 7/16"X 20 | 3/4"X 16 | 14 | 16.7 | 38.5 | 22 | |
| 1J-05 | 1/2"X 20 | 1/2"X 20 | 14 | 14 | 34 | 14 | |
| 1J-05-06 | 1/2"X 20 | 9/16"X 18 | 14 | 14.1 | 34 | 17 | |
| 1J-05-08 | 1/2"X 20 | 3/4"X 16 | 14 | 16.7 | 38.5 | 22 | |
| 1J-05-10 | 1/2"X 20 | 7/8"X 14 | 14 | 19.3 | 41 | 24 | |
| 1J-06 | 9/16"X 18 | 9/16"X 18 | 14.1 | 14.1 | 34.2 | 17 | |
| 1J-06-08 | 9/16"X 18 | 3/4"X 16 | 14.1 | 16.7 | 38.5 | 22 | |
| 1J-06-10 | 9/16"X 18 | 7/8"X 14 | 14.1 | 19.3 | 41.5 | 24 | |
| 1J-06-12 | 9/16"X 18 | 1.1/16"X 12 | 14.1 | 21.9 | 46 | 30 | |
| 1J-08 | 3/4"X 16 | 3/4"X 16 | 16.7 | 16.7 | 42 | 22 | |
| 1J-08-10 | 3/4"X 16 | 7/8"X 14 | 16.7 | 19.3 | 44 | 24 | |
| 1J-08-12 | 3/4"X 16 | 1.1/16"X 12 | 16.7 | 21.9 | 48.5 | 30 | |
| 1J-08-16 | 3/4"X 16 | 1.5/16"X 12 | 16.7 | 23.1 | 51 | 36 | |
| 1J-10 | 7/8"X 14 | 7/8"X 14 | 19.3 | 19.3 | 46.5 | 24 | |
| 1J-10-12 | 7/8"X 14 | 1.1/16"X 12 | 19.3 | 21.9 | 51 | 30 | |
| 1J-10-16 | 7/8"X 14 | 1.5/16"X 12 | 19.3 | 23.1 | 53.5 | 36 | |
| 1J-12 | 1.1/16"X 12 | 1.1/16"X 12 | 21.9 | 21.9 | 54 | 30 | |
| 1J-12-14 | 1.1/16"X 12 | 1.3/16"X 12 | 21.9 | 22.6 | 55.5 | 32 | |
| 1J-12-16 | 1.1/16"X 12 | 1.5/16"X 12 | 21.9 | 23.1 | 56 | 36 | |
| 1J-14 | 1.3/16"X 12 | 1.3/16"X 12 | 22.6 | 22.6 | 56 | 32 | |
| 1J-14-16 | 1.3/16"X 12 | 1.5/16"X 12 | 22.6 | 23.1 | 56.5 | 36 | |
| 1J-16 | 1.5/16"X 12 | 1.5/16"X 12 | 23.1 | 23.1 | 57 | 36 | |
| 1J-16-20 | 1.5/16"X 12 | 1.5/8"X 12 | 23.1 | 24.3 | 60.5 | 46 | |
| 1J-16-24 | 1.5/16"X 12 | 1.7/8"X 12 | 23.1 | 27.5 | 65.5 | 50 | |
| 1J-20 | 1.5/8"X 12 | 1.5/8"X 12 | 24.3 | 24.3 | 61 | 46 | |
| 1J-20-24 | 1.5/8"X 12 | 1.7/8"X 12 | 24.3 | 27.5 | 67 | 50 | |
| 1J-20-32 | 1.5/8"X 12 | 2.1/2"X 12 | 24.3 | 33.9 | 75 | 65 | |
| 1J-24 | 1.7/8"X 12 | 1.7/8"X 12 | 27.5 | 27.5 | 69 | 50 | |
| 1J-24-32 | 1.7/8"X 12 | 2.1/2"X 12 | 27.5 | 33.9 | 78.5 | 65 | |
| 1J-32 | 2.1/2"X 12 | 2.1/2"X 12 | 33.9 | 33.9 | 85 | 65 | |

注：螺母及衬套需另行订货。管子直径D为公制时，配用螺母及衬套分别选用NB200、NB500。管子直径为英制时，配用螺母及衬套分别选用NB200、NB300。 Note: Nut and sleeve should be ordered separately. The nut NB200 and sleeve NB500 is suitable for metric tube, the nut NB200 and sleeve NB300 is suitable for inch tube.

H

美制螺纹JIC 74° 锥面扩口接头 JIC 74° Cone Flared Tube Fittings

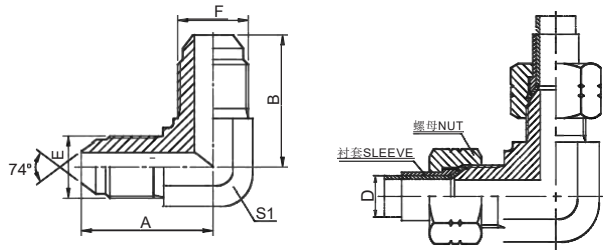

90° 弯美制JIC外螺纹74° 外锥
90° ELBOW JIC MALE 74° CONE

1J9

| 代号 PART NO. | 螺 纹 THREAD | | 尺 寸 DIMENSIONS | | | | | |
|----------------|------------|------------|----------------|------|----|--|--|--|
| | E | F | A | B | S1 | | | |
| 1J9-02 | 5/16"X24 | 5/16"X24 | 20.5 | 20.5 | 11 | | | |
| 1J9-03 | 3/8"X24 | 3/8"X24 | 22 | 22 | 11 | | | |
| 1J9-04 | 7/16"X20 | 7/16"X20 | 24.5 | 24.5 | 11 | | | |
| 1J9-05 | 1/2"X20 | 1/2"X20 | 26.6 | 26.6 | 14 | | | |
| 1J9-05-06 | 1/2"X20 | 9/16"X18 | 26.6 | 26.9 | 14 | | | |
| 1J9-06 | 9/16"X18 | 9/16"X18 | 26.9 | 26.9 | 14 | | | |
| 1J9-06-08 | 9/16"X18 | 3/4"X16 | 30 | 32 | 19 | | | |
| 1J9-06-10 | 9/16"X18 | 7/8"X14 | 32 | 37.8 | 22 | | | |
| 1J9-08 | 3/4"X16 | 3/4"X16 | 32 | 32 | 19 | | | |
| 1J9-08-10 | 3/4"X16 | 7/8"X14 | 34.8 | 37.8 | 22 | | | |
| 1J9-10 | 7/8"X14 | 7/8"X14 | 37.8 | 37.8 | 22 | | | |
| 1J9-10-12 | 7/8"X14 | 1.1/16"X12 | 41 | 44.2 | 27 | | | |
| 1J9-12 | 1.1/16"X12 | 1.1/16"X12 | 44.2 | 44.2 | 27 | | | |
| 1J9-14 | 1.3/16"X12 | 1.3/16"X12 | 47.5 | 47.5 | 30 | | | |
| 1J9-16 | 1.5/16"X12 | 1.5/16"X12 | 49 | 49 | 33 | | | |
| 1J9-20 | 1.5/8"X12 | 1.5/8"X12 | 55.5 | 55.5 | 41 | | | |
| 1J9-24 | 1.7/8"X12 | 1.7/8"X12 | 62.5 | 62.5 | 48 | | | |
| 1J9-32 | 2.1/2"X12 | 2.1/2"X12 | 78 | 78 | 63 | | | |

注：螺母及衬套需另行订货。管子直径D为公制时，配用螺母及衬套分别选用NB200、NB500。管子直径为英制时，配用螺母及衬套分别选用NB200、NB300。Note: Nut and sleeve should be ordered separately. The nut NB200 and sleeve NB500 is suitable for metric tube, the nut NB200 and sleeve NB300 is suitable for inch tube.

美制螺纹JIC 74° 锥面扩口接头 JIC 74° Cone Flared Tube Fittings

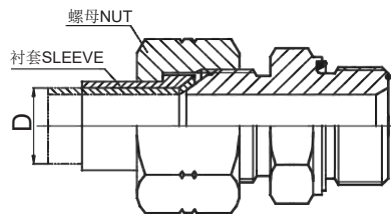
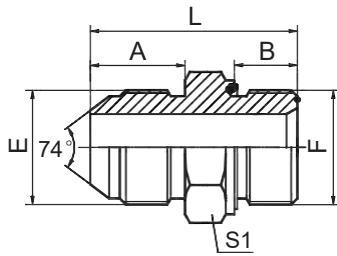

JIC外螺纹74° 外
锥 / 英管外螺纹胶垫密封
JIC MALE 74°
CONE / BSP MALE CAPTIVE SEAL

1JB-WD

| 代号 PART NO. | 螺 纹 THREAD | | 胶 垫 CAPTIVE | F端 | 尺 寸 DIMENSIONS | | | | |
|----------------|------------|------------|-------------|--------|----------------|----|------|----|--|
| | E | F | | | A | B | L | S1 | |
| 1JB-04-02WD | 7/16"X20 | G1/8"X28 | | WD-B02 | 14 | 8 | 29.5 | 14 | |
| 1JB-04WD | 7/16"X20 | G1/4"X19 | | WD-B04 | 14 | 12 | 34 | 19 | |
| 1JB-04-06WD | 7/16"X20 | G3/8"X19 | | WD-B06 | 14 | 12 | 34.5 | 22 | |
| 1JB-04-08WD | 7/16"X20 | G1/2"X14 | | WD-B08 | 14 | 14 | 41 | 27 | |
| 1JB-05-04WD | 1/2"X20 | G1/4"X19 | | WD-B04 | 14 | 12 | 34 | 19 | |
| 1JB-05-06WD | 1/2"X20 | G3/8"X19 | | WD-B06 | 14 | 12 | 34.5 | 22 | |
| 1JB-06-02WD | 9/16"X18 | G1/8"X28 | | WD-B02 | 14.1 | 8 | 29.5 | 17 | |
| 1JB-06-04WD | 9/16"X18 | G1/4"X19 | | WD-B04 | 14.1 | 12 | 34 | 19 | |
| 1JB-06WD | 9/16"X18 | G3/8"X19 | | WD-B06 | 14.1 | 12 | 34.5 | 22 | |
| 1JB-06-08WD | 9/16"X18 | G1/2"X14 | | WD-B08 | 14.1 | 14 | 41 | 27 | |
| 1JB-08-04WD | 3/4"X16 | G1/4"X19 | | WD-B04 | 16.7 | 12 | 37 | 22 | |
| 1JB-08-06WD | 3/4"X16 | G3/8"X19 | | WD-B06 | 16.7 | 12 | 37.5 | 22 | |
| 1JB-08WD | 3/4"X16 | G1/2"X14 | | WD-B08 | 16.7 | 14 | 43.5 | 27 | |
| 1JB-10-08WD | 7/8"X14 | G1/2"X14 | | WD-B08 | 19.3 | 14 | 46.5 | 27 | |
| 1JB-10-12WD | 7/8"X14 | G3/4"X14 | | WD-B12 | 19.3 | 16 | 47.5 | 32 | |
| 1JB-12-08WD | 1.1/16"X12 | G1/2"X14 | | WD-B08 | 21.9 | 14 | 48.5 | 30 | |
| 1JB-12WD | 1.1/16"X12 | G3/4"X14 | | WD-B12 | 21.9 | 16 | 50 | 32 | |
| 1JB-12-16WD | 1.1/16"X12 | G1"X11 | | WD-B16 | 21.9 | 18 | 56 | 41 | |
| 1JB-16-12WD | 1.5/16"X12 | G3/4"X14 | | WD-B12 | 23.1 | 16 | 53 | 36 | |
| 1JB-16WD | 1.5/16"X12 | G1"X11 | | WD-B16 | 23.1 | 18 | 57 | 41 | |
| 1JB-16-20WD | 1.5/16"X12 | G1.1/4"X11 | | WD-B20 | 23.1 | 20 | 61 | 50 | |
| 1JB-20-16WD | 1.5/8"X12 | G1"X11 | | WD-B16 | 24.3 | 18 | 58 | 46 | |
| 1JB-20WD | 1.5/8"X12 | G1.1/4"X11 | | WD-B20 | 24.3 | 20 | 62 | 50 | |
| 1JB-20-24WD | 1.5/8"X12 | G1.1/2"X11 | | WD-B24 | 24.3 | 22 | 64 | 55 | |
| 1JB-24-20WD | 1.7/8"X12 | G1.1/4"X11 | | WD-B20 | 27.5 | 20 | 65.5 | 50 | |
| 1JB-24WD | 1.7/8"X12 | G1.1/2"X11 | | WD-B24 | 27.5 | 22 | 67.5 | 55 | |

注：螺母及衬套需另行订货。管子直径D为公制时，配用螺母及衬套分别选用NB200、NB500。管子直径为英制时，配用螺母及衬套分别选用NB200、NB300。Note: Nut and sleeve should be ordered separately. The nut NB200 and sleeve NB500 is suitable for metric tube, the nut NB200 and sleeve NB300 is suitable for inch tube.

H

美制螺纹JIC 74° 锥面扩口接头 JIC 74° Cone Flared Tube Fittings

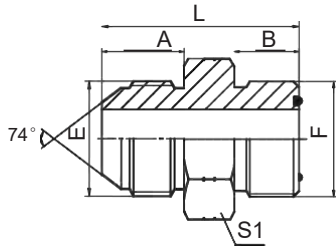

1JF

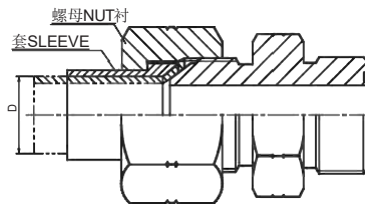

美制JIC外螺纹74° 外锥 / ORFS外螺纹
JIC MALE 74° CONE / ORFS MALE

| 代 号 PART NO. | 螺 纹 THREAD | | O形圈 O-RING | | 尺 寸 DIMENSIONS | | | | |
|-----------------|---------------|-------------|---------------|------|-------------------|------|------|----|--|
| | E | F | | F端 | A | B | L | S1 | |
| 1JF-04 | 7/16"X20 | 9/16"X18 | | O011 | 14 | 9.8 | 29.5 | 17 | |
| 1JF-05-04 | 1/2"X20 | 9/16"X18 | | O011 | 14 | 9.8 | 29.5 | 17 | |
| 1JF-05-06 | 1/2"X20 | 11/16"X16 | | O012 | 14 | 11.2 | 31.5 | 19 | |
| 1JF-06-04 | 9/16"X18 | 9/16"X18 | | O011 | 14.1 | 9.8 | 30 | 17 | |
| 1JF-06 | 9/16"X18 | 11/16"X16 | | O012 | 14.1 | 11.2 | 31 | 19 | |
| 1JF-08-06 | 3/4"X16 | 11/16"X16 | | O012 | 16.7 | 11.2 | 36 | 22 | |
| 1JF-08 | 3/4"X16 | 13/16"X16 | | O014 | 16.7 | 12.8 | 37.5 | 22 | |
| 1JF-10-08 | 7/8"X14 | 13/16"X16 | | O014 | 19.3 | 12.8 | 40 | 24 | |
| 1JF-10 | 7/8"X14 | 1"X14 | | O016 | 19.3 | 15.5 | 44.5 | 27 | |
| 1JF-12-10 | 1.1/16"X12 | 1"X14 | | O016 | 21.9 | 15.5 | 47.5 | 30 | |
| 1JF-12 | 1.1/16"X12 | 1.3/16"X12 | | O018 | 21.9 | 17 | 50 | 32 | |
| 1JF-16-12 | 1.5/16"X12 | 1.3/16"X12 | | O018 | 23.1 | 17 | 51 | 36 | |
| 1JF-16 | 1.5/16"X12 | 1.7/16"X12 | | O021 | 23.1 | 17.5 | 51.5 | 38 | |
| 1JF-20-16 | 1.5/8"X12 | 1.7/16"X12 | | O021 | 24.3 | 17.5 | 54.5 | 46 | |
| 1JF-20 | 1.5/8"X12 | 1.11/16"X12 | | O025 | 24.3 | 17.5 | 54.5 | 46 | |
| 1JF-24-20 | 1.7/8"X12 | 1.11/16"X12 | | O025 | 27.5 | 17.5 | 60 | 50 | |
| 1JF-24 | 1.7/8"X12 | 2"X12 | | O029 | 27.5 | 17.5 | 60 | 55 | |

注：螺母及衬套需另行订货。管子直径D为公制时， 配用螺母及衬套分别选用NB200、NB500。管子直径为英制时， 配用螺母及衬套分别选用NB200、NB300。 Note: Nut and sleeve should be ordered separately. The nut NB200 and sleeve NB500 is suitable for metric tube, the nut NB200 and sleeve NB300 is suitable for inch tube.

美制螺纹JIC 74° 锥面扩口接头 JIC 74° Cone Flared Tube Fittings

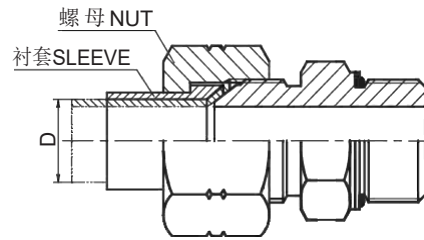
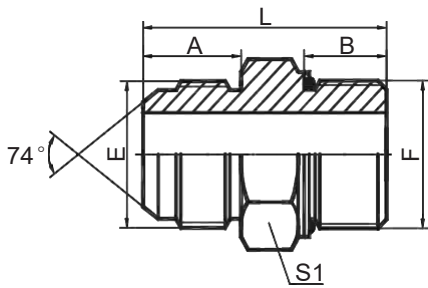

1JG

美制JIC外螺纹74° 外锥 / 英管外螺纹O形圈
JIC MALE 74° CONE / BSP MALE O-RING

| 代号 PART NO. | 螺纹 THREA D | | O形圈 O-RING | | 尺寸 DIMENSIONS | | | | |
|----------------|-------------|-------------|------------|-------|---------------|------|------|----|--|
| | E | F | | F端 | A | B | L | S1 | |
| 1JG-04-02 | 7/16" X20 | G1/8"X28 | | O011 | 14 | 9.5 | 29.5 | 14 | |
| 1JG-04 | 7/16" X20 | G1/4"X19 | | O111 | 14 | 10 | 32.5 | 19 | |
| 1JG-04-06 | 7/16" X20 | G3/8"X19 | | O113 | 14 | 11.5 | 34 | 24 | |
| 1JG-04-08 | 7/16" X20 | G1/2"X14 | | O115 | 14 | 14 | 39 | 27 | |
| 1JG-05-04 | 1/2"X20 | G1/4"X19 | | O111 | 14 | 10 | 33 | 19 | |
| 1JG-05-06 | 1/2"X20 | G3/8"X19 | | O113 | 14 | 11.5 | 35 | 24 | |
| 1JG-05-08 | 1/2"X20 | G1/2"X14 | | O115 | 14 | 14 | 39 | 27 | |
| 1JG-06-04 | 9/16" X18 | G1/4"X19 | | O111 | 14.1 | 11 | 31.5 | 19 | |
| 1JG-06 | 9/16" X18 | G3/8"X19 | | O113 | 14.1 | 11.5 | 34 | 24 | |
| 1JG-06-08 | 9/16" X18 | G1/2"X14 | | O115 | 14.1 | 14 | 37.5 | 27 | |
| 1JG-08-04 | 3/4"X16 | G1/4"X19 | | O111 | 16.7 | 11 | 35.5 | 22 | |
| 1JG-08-06 | 3/4"X16 | G3/8"X19 | | O113 | 16.7 | 11.5 | 37 | 24 | |
| 1JG-08 | 3/4"X16 | G1/2"X14 | | O115 | 16.7 | 14 | 40.5 | 27 | |
| 1JG-08-12 | 3/4"X16 | G3/4"X14 | | O119 | 16.7 | 15.5 | 43 | 36 | |
| 1JG-10-06 | 7/8"X14 | G3/8"X19 | | O113 | 19.3 | 11.5 | 39.5 | 24 | |
| 1JG-10-08 | 7/8"X14 | G1/2"X14 | | O115 | 19.3 | 14 | 43 | 27 | |
| 1JG-10-12 | 7/8"X14 | G3/4"X14 | | O119 | 19.3 | 15.5 | 47 | 36 | |
| 1JG-12-08 | 1.1/16" X12 | G1/2"X14 | | O115 | 22 | 14 | 47.5 | 30 | |
| 1JG-12 | 1.1/16" X12 | G3/4"X14 | | O119 | 22 | 15.5 | 49.5 | 36 | |
| 1JG-12-16 | 1.1/16" X12 | G1"X11 | | O217 | 22 | 18 | 52.5 | 41 | |
| 1JG-12-20 | 1.1/16" X12 | G1.1/4" X11 | | O222 | 22 | 20 | 57 | 50 | |
| 1JG-16-12 | 1.5/16" X12 | G3/4"X14 | | O119 | 23 | 15.5 | 51 | 36 | |
| 1JG-16 | 1.5/16" X12 | G1"X11 | | O217 | 23 | 18 | 55 | 41 | |
| 1JG-16-20 | 1.5/16" X12 | G1.1/4" X11 | | O22 2 | 23 | 20 | 59.5 | 50 | |
| 1JG-20-16 | 1.5/8" X12 | G1"X11 | | O217 | 24.3 | 18 | 56.5 | 46 | |
| 1JG-20 | 1.5/8" X12 | G1.1/4" X11 | | O222 | 24.3 | 20 | 59.5 | 50 | |
| 1JG-24-16 | 1.7/8" X12 | G1"X11 | | O217 | 27.5 | 18 | 62 | 50 | |
| 1JG-24-20 | 1.7/8" X12 | G1.1/4" X11 | | O222 | 27.5 | 20 | 65.5 | 50 | |
| 1JG-24 | 1.7/8" X12 | G1.1/2" X11 | | O224 | 27.5 | 21.5 | 64 | 60 | |

注：螺母及衬套需另行订货。管子直径D为公制时，配用螺母及衬套分别选用NB200、NB500。管子直径为英制时，配用螺母及衬套分别选用NB200、NB300。 Note: Nut and sleeve should be ordered separately. The nut NB200 and sleeve NB500 is suitable for metric tube, the nut NB200 and sleeve NB300 is suitable for inch tube.

H

美制螺纹JIC 74° 锥面扩口接头 JIC 74° Cone Flared Tube Fittings

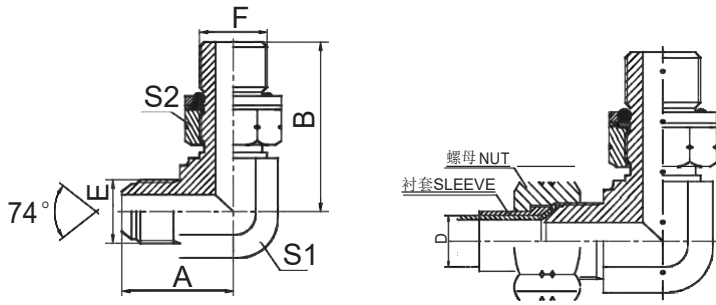

90° 弯美制JIC外螺纹
74° 外锥 / 英管外螺纹O形圈
90° ELBOW JIC MALE
74° CONE / BSP MALE O-RING

1JG9-OG

| 代号 PART NO. | 螺纹 THREAD | | O 形圈 O-RING | | 尺寸 DIMENSIONS | | | | |
|----------------|------------|------------|-------------|------|---------------|------|----|----|--|
| | E | F | | F端 | A | B | S1 | S2 | |
| 1JG9-04-02OG | 7/16"X20 | G1/8"X28 | | O011 | 24.5 | 25.5 | 11 | 14 | |
| 1JG9-04-06OG | 7/16"X20 | G3/8"X19 | | O113 | 27.5 | 36.8 | 16 | 22 | |
| 1JG9-04OG | 7/16"X20 | G1/4"X19 | | O111 | 26.6 | 31.3 | 14 | 19 | |
| 1JG9-05-04OG | 1/2"X20 | G1/4"X19 | | O111 | 26.5 | 31.8 | 14 | 19 | |
| 1JG9-05-06OG | 1/2"X20 | G3/8"X19 | | O113 | 28 | 35.5 | 16 | 22 | |
| 1JG9-05-08OG | 1/2"X20 | G1/2"X14 | | O115 | 31.5 | 43.2 | 22 | 27 | |
| 1JG9-06-04OG | 9/16"X18 | G1/4"X19 | | O111 | 26.9 | 31.3 | 14 | 19 | |
| 1JG9-06-08OG | 9/16"X18 | G1/2"X14 | | O115 | 32.5 | 43.2 | 22 | 27 | |
| 1JG9-06OG | 9/16"X18 | G3/8"X19 | | O113 | 28.5 | 35.8 | 16 | 22 | |
| 1JG9-08-04OG | 3/4"X16 | G1/4"X19 | | O111 | 32 | 33.5 | 19 | 19 | |
| 1JG9-08OG | 3/4"X16 | G1/2"X14 | | O115 | 34.8 | 43.2 | 22 | 27 | |
| 1JG9-08-06OG | 3/4"X16 | G3/8"X19 | | O113 | 32 | 36.8 | 19 | 22 | |
| 1JG9-08-12OG | 3/4"X16 | G3/4"X14 | | O119 | 37.9 | 49.3 | 27 | 32 | |
| 1JG9-10-06OG | 7/8"X14 | G3/8"X19 | | O113 | 37.8 | 39.2 | 22 | 22 | |
| 1JG9-10-08OG | 7/8"X14 | G1/2"X14 | | O115 | 37.8 | 43.2 | 22 | 27 | |
| 1JG9-10-12OG | 7/8"X14 | G3/4"X14 | | O119 | 41 | 49.3 | 27 | 32 | |
| 1JG9-12OG | 1.1/16"X12 | G3/4"X14 | | O119 | 44.2 | 49.3 | 27 | 32 | |
| 1JG9-12-08OG | 1.1/16"X12 | G1/2"X14 | | O115 | 44.2 | 46.5 | 27 | 27 | |
| 1JG9-12-16OG | 1.1/16"X12 | G1"X11 | | O217 | 48 | 53 | 33 | 41 | |
| 1JG9-16OG | 1.5/16"X12 | G1"X11 | | O217 | 49 | 53 | 33 | 41 | |
| 1JG9-16-12OG | 1.5/16"X12 | G3/4"X14 | | O119 | 49 | 53 | 33 | 32 | |
| 1JG9-16-20OG | 1.5/16"X12 | G1.1/4"X11 | | O222 | 53.8 | 58 | 41 | 50 | |
| 1JG9-20OG | 1.5/8"X12 | G1.1/4"X11 | | O222 | 55.5 | 58 | 41 | 50 | |
| 1JG9-20-16OG | 1.5/8"X12 | G1"X11 | | O217 | 55.5 | 58 | 41 | 41 | |
| 1JG9-24-16OG | 1.7/8"X12 | G1"X11 | | O217 | 62.5 | 63 | 48 | 41 | |
| 1JG9-24-20OG | 1.7/8"X12 | G1.1/4"X11 | | O222 | 62.5 | 63 | 48 | 50 | |
| 1JG9-24OG | 1.7/8"X12 | G1.1/2"X11 | | O224 | 62.5 | 63 | 48 | 55 | |

注：1 螺母及衬套需另行订货。管子直径D为公制时，配用螺母及衬套分别选用NB200、NB500。管子直径为英制时，配用螺母及衬套分别选用NB200、NB300。2 F端与DIN 3852油口相配。 Note: 1 Nut and sleeve should be ordered separately. The nut NB200 and sleeve NB500 is suitable for metric tube, the nut NB200 and sleeve NB300 is suitable for inch tube. 2 F end is connected with DIN 3852 port.

美制螺纹JIC 74° 锥面扩口接头 JIC 74° Cone Flared Tube Fittings

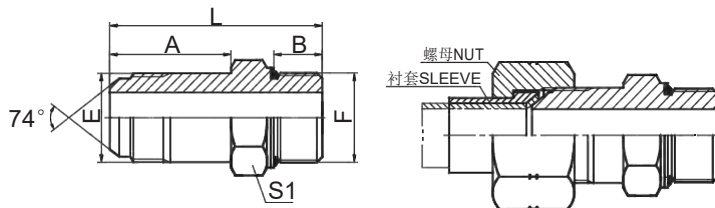

1JG-L

加长JIC外螺纹
74° 外锥 / BSPP外螺纹带O形圈
LONG JIC MALE
74° CONE / BSPP O-RING BOSS

| 代号 PART NO. | 螺纹 THREAD | | O形圈 O-RING | | 尺寸 DIMENSIONS | | | | |
|----------------|------------|------------|------------|------------|---------------|------|-------|----|--|
| | E | F | | F端 | A | B | L | S1 | |
| 1JG-04L | 7/16"X20 | G1/4"X19 | | 10.77X2.62 | 35 | 10 | 53 | 19 | |
| 1JG-06-04L | 9/16"X18 | G1/4"X19 | | 10.77X2.62 | 39.5 | 10 | 57 | 22 | |
| 1JG-06L | 9/16"X18 | G3/8"X19 | | 13.94X2.62 | 39.5 | 11.5 | 59.5 | 24 | |
| 1JG-08-06L | 3/4"X16 | G3/8"X19 | | 13.94X2.62 | 48 | 11.5 | 68.5 | 24 | |
| 1JG-08L | 3/4"X16 | G1/2"X14 | | 10.77X2.62 | 48 | 14 | 73.5 | 27 | |
| 1JG-10-08L | 7/8"X14 | G1/2"X14 | | 10.77X2.62 | 53 | 14 | 78 | 27 | |
| 1JG-12L | 1.1/16"X12 | G3/4"X14 | | 23.47X2.62 | 63 | 15.5 | 90.5 | 36 | |
| 1JG-12-16L | 1.5/16"X12 | G1"X11 | | 29.74X3.53 | 63 | 18 | 95 | 41 | |
| 1JG-16L | 1.5/16"X12 | G1"X11 | | 29.74X3.53 | 72 | 18 | 104 | 41 | |
| 1JG-20L | 1.5/8"X12 | G1.1/4"X11 | | 37.69X3.53 | 88.1 | 20 | 123.5 | 50 | |

注：螺母及衬套需另行订货。管子直径D为公制时，配用螺母及衬套分别选用NB200、NB500。管子直径为英制时，配用螺母及衬套分别选用NB200、NB300。Nut and sleeve should be ordered separately. The nut NB200 and sleeve NB500 is suitable for metric tube, the nut NB200 and sleeve NB300 is suitable for inch tube.

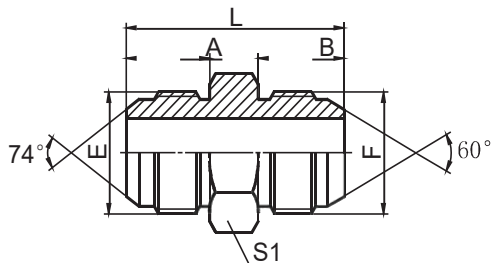

1JK

美制JIC外螺纹74° / 日本公制外螺纹60°
JIC MALE 74° / JIS METRIC MALE 60°

| 代号 PART NO. | 螺纹 THREAD | | 尺寸 DIMENSIONS | | | | | |
|----------------|------------|---------|---------------|--|------|------|------|----|
| | E | F | | | A | B | L | S1 |
| 1JK-04-14 | 7/16"X20 | M14X1.5 | | | 14 | 17 | 37 | 17 |
| 1JK-06-18 | 9/16"X18 | M18X1.5 | | | 14.1 | 18 | 38 | 19 |
| 1JK-08-22 | 3/4"X16 | M22X1.5 | | | 16.7 | 20 | 44.5 | 24 |
| 1JK-10-24 | 7/8"X14 | M24X1.5 | | | 19.3 | 21.5 | 51 | 27 |
| 1JK-12-22 | 1.1/16"X12 | M22X1.5 | | | 21.9 | 20 | 52 | 30 |
| 1JK-12-24 | 1.1/16"X12 | M24X1.5 | | | 21.9 | 21.5 | 53.5 | 30 |
| 1JK-12-30 | 1.1/16"X12 | M30X1.5 | | | 21.9 | 26 | 59 | 32 |
| 1JK-16-33 | 1.5/16"X12 | M33X1.5 | | | 23.1 | 30 | 64 | 36 |
| 1JK-20-36 | 1.5/8"X12 | M36X1.5 | | | 24.3 | 33 | 70 | 46 |
| 1JK-24-42 | 1.7/8"X12 | M42X1.5 | | | 27.5 | 36 | 78.5 | 50 |

美制螺纹JIC 74° 锥面扩口接头 JIC 74° Cone Flared Tube Fittings

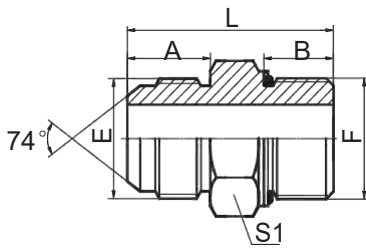

1JH

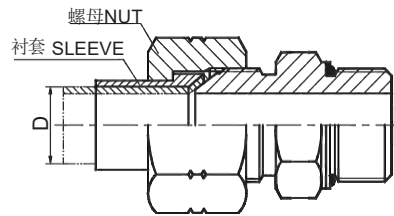

JIC外螺纹74° 外锥 / 公制外螺纹
可调向柱端轻系列 ISO 6149-3

JIC MALE 74° CONE / METIRC MALE ADJUSTABLE
STUD END L-SERIES ISO 6149-3

| 代号 PART NO. | 螺纹 THREAD | | O形圈 O-RING | | 尺寸 DIMENSIONS | | | | |
|----------------|------------|---------|------------|-----------|---------------|------|------|----|--|
| | E | F | | F端 | A | B | L | S1 | |
| 1JH-04-10 | 7/16"X20 | M10X1 | | O08.1X1.6 | 14 | 8.5 | 28.5 | 14 | |
| 1JH-04-12 | 7/16"X20 | M12X1.5 | | O09.3X2.4 | 14 | 11 | 31 | 17 | |
| 1JH-04-14 | 7/16"X20 | M14X1.5 | | O11.3X2.4 | 14 | 11 | 31 | 19 | |
| 1JH-05-10 | 1/2"X20 | M10X1 | | O08.1X1.6 | 14 | 8.5 | 29 | 14 | |
| 1JH-05-12 | 1/2"X20 | M12X1.5 | | O09.3X2.4 | 14 | 11 | 31 | 17 | |
| 1JH-05-14 | 1/2"X20 | M14X1.5 | | O11.3X2.4 | 14 | 11 | 33 | 19 | |
| 1JH-06-14 | 9/16"X18 | M14X1.5 | | O11.3X2.4 | 14.1 | 11 | 31 | 19 | |
| 1JH-06-16 | 9/16"X18 | M16X1.5 | | O13.3X2.4 | 14.1 | 11.5 | 33.5 | 22 | |
| 1JH-06-18 | 9/16"X18 | M18X1.5 | | O15.3X2.4 | 14.1 | 12.5 | 34.5 | 24 | |
| 1JH-08-14 | 3/4"X16 | M14X1.5 | | O15.3X2.4 | 16.7 | 11 | 38 | 22 | |
| 1JH-08-16 | 3/4"X16 | M16X1.5 | | O13.3X2.4 | 16.7 | 11.5 | 36 | 22 | |
| 1JH-08-18 | 3/4"X16 | M18X1.5 | | O15.3X2.4 | 16.7 | 12.5 | 37 | 24 | |
| 1JH-08-22 | 3/4"X16 | M22X1.5 | | O19.3X2.4 | 16.7 | 13 | 39.5 | 27 | |
| 1JH-10-16 | 7/8"X14 | M16X1.5 | | O13.3X2.4 | 19.3 | 11.5 | 41 | 24 | |
| 1JH-10-18 | 7/8"X14 | M18X1.5 | | O15.3X2.4 | 19.3 | 12.5 | 40 | 24 | |
| 1JH-10-22 | 7/8"X14 | M22X1.5 | | O19.3X2.4 | 19.3 | 13 | 42 | 27 | |
| 1JH-12-22 | 1.1/16"X12 | M22X1.5 | | O19.3X2.4 | 21.9 | 13 | 47.5 | 30 | |
| 1JH-12-27 | 1.1/16"X12 | M27X2 | | O23.5X3.0 | 21.9 | 16 | 51.5 | 32 | |
| 1JH-16-27 | 1.5/16"X12 | M27X2 | | O23.5X3.0 | 23.1 | 16 | 52.5 | 36 | |
| 1JH-16-33 | 1.5/16"X12 | M33X2 | | O29.5X3.0 | 23.1 | 16 | 52 | 41 | |
| 1JH-20-42 | 1.5/8"X12 | M42X2 | | O38.5X3.0 | 24.3 | 16 | 58 | 50 | |
| 1JH-24-48 | 1.7/8"X12 | M48X2 | | O44.5X3.0 | 27.5 | 17.5 | 63 | 55 | |

注：1螺母及衬套需另行订货。管子直径D为公制时，配用螺母及衬套分别选用NB200、NB500。管子直径为英制时，配用螺母及衬套分别选用NB200、NB300。2 F端可与ISO 9974-1油口相配，去掉挡圈与ISO 6149-1油口相配。

Note: 1 Nut and sleeve should be ordered separately. The nut NB200 and sleeve NB500 is suitable for metric tube, the nut NB200 and sleeve NB300 is suitable for inch tube. 2 F end is fit for ISO 9974-1 port or ISO 6149-1 port when useless of retaining ring.

美制螺纹JIC 74° 锥面扩口接头 JIC 74° Cone Flared Tube Fittings

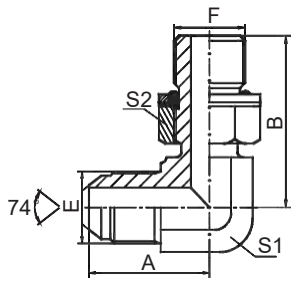

1JH9-OG

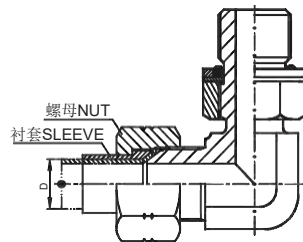

90° 弯美制JIC外螺纹

74° 外锥 / 公制外螺纹可调向柱端轻系列 ISO 6149-3

90° ELBOW JIC MALE 74° CONE / METIRC

MALE ADJUSTABLE STUD END L-SERIES ISO 6149-3

| 代号 PART NO. | 螺纹 THREAD | | O形圈 O-RING | | 尺寸 DIMENSIONS | | | | |
|----------------|------------|---------|------------|-----------|---------------|------|----|----|--|
| | E | F | | F端 | A | B | S1 | S2 | |
| 1JH9-04-10OG | 7/16"X20 | M10X1 | | O08.1X1.6 | 24.5 | 27.5 | 11 | 14 | |
| 1JH9-04-12OG | 7/16"X20 | M12X1.5 | | O09.3X2.4 | 24.5 | 30.3 | 11 | 17 | |
| 1JH9-04-14OG | 7/16"X20 | M14X1.5 | | O11.3X2.4 | 26.6 | 32 | 14 | 19 | |
| 1JH9-05-10OG | 1/2"X20 | M10X1 | | O08.1X1.6 | 26.5 | 28.5 | 14 | 14 | |
| 1JH9-05-12OG | 1/2"X20 | M12X1.5 | | O09.3X2.4 | 26.5 | 32 | 14 | 17 | |
| 1JH9-05-14OG | 1/2"X20 | M14X1.5 | | O11.3X2.4 | 26.5 | 32 | 14 | 19 | |
| 1JH9-06-14OG | 9/16"X18 | M14X1.5 | | O11.3X2.4 | 26.9 | 32 | 14 | 19 | |
| 1JH9-06-16OG | 9/16"X18 | M16X1.5 | | O13.3X2.4 | 28 | 34.8 | 16 | 22 | |
| 1JH9-06-18OG | 9/16"X18 | M18X1.5 | | O15.3X2.4 | 30 | 37 | 19 | 24 | |
| 1JH9-08-16OG | 3/4"X16 | M16X1.5 | | O13.3X2.4 | 32 | 36 | 19 | 22 | |
| 1JH9-08-18OG | 3/4"X16 | M18X1.5 | | O15.3X2.4 | 33 | 37 | 19 | 24 | |
| 1JH9-08-22OG | 3/4"X16 | M22X1.5 | | O19.3X2.4 | 34.8 | 40.2 | 22 | 27 | |
| 1JH9-10-16OG | 7/8"X14 | M16X1.5 | | O13.3X2.4 | 38 | 38 | 22 | 22 | |
| 1JH9-10-18OG | 7/8"X14 | M18X1.5 | | O15.3X2.4 | 38 | 39.5 | 22 | 24 | |
| 1JH9-10-22OG | 7/8"X14 | M22X1.5 | | O19.3X2.4 | 38 | 42.5 | 22 | 27 | |
| 1JH9-12-22OG | 1.1/16"X12 | M22X1.5 | | O19.3X2.4 | 45 | 44 | 27 | 27 | |
| 1JH9-12-27OG | 1.1/16"X12 | M27X2 | | O23.5X3.0 | 44.2 | 48.5 | 27 | 32 | |
| 1JH9-16-27OG | 1.5/16"X12 | M27X2 | | O23.5X3.0 | 49 | 52 | 33 | 32 | |
| 1JH9-16-33OG | 1.5/16"X12 | M33X2 | | O29.5X3.0 | 49 | 52.5 | 33 | 41 | |
| 1JH9-20-42OG | 1.5/8"X12 | M42X2 | | O38.5X3.0 | 55.5 | 57.2 | 41 | 50 | |
| 1JH9-24-48OG | 1.7/8"X12 | M48X2 | | O44.5X3.0 | 62.5 | 62.5 | 48 | 55 | |

注：1螺母及衬套需另行订货。管子直径D为公制时， 配用螺母及衬套分别选用NB200、NB500。管子直径为英制时， 配用螺母及衬套分别选用NB200、NB300。 2 F端可与ISO 9974-1油口相配， 去掉挡圈与ISO 6149-1油口相配。
 Note: 1 Nut and sleeve should be ordered separately. The nut NB200 and sleeve NB500 is suitable for metric tube, the nut NB200 and sleeve NB300 is suitable for inch tube. 2 F end is fit for ISO 9974-1 port or ISO 6149-1 port when useless of retaining ring.

H

美制螺纹JIC 74° 锥面扩口接头 JIC 74° Cone Flared Tube Fittings

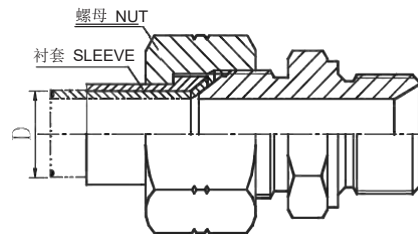
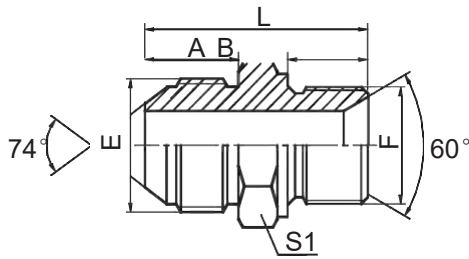

1JM

JIC外螺纹74° 外锥 / 公制外螺纹60° 内锥
JIC MALE 74° CONE / METRIC MALE 60° SEAT

| 代号 PART NO. | 螺纹 THREAD | | 尺寸 DIMENSIONS | | | | | |
|----------------|------------|---------|---------------|----|------|----|--|--|
| | E | F | A | B | L | S1 | | |
| 1JM-04-10 | 7/16"X20 | M10X1 | 14 | 8 | 29 | 14 | | |
| 1JM-04-12 | 7/16"X20 | M12X1.5 | 14 | 10 | 31 | 17 | | |
| 1JM-04-14 | 7/16"X20 | M14X1.5 | 14 | 11 | 32 | 19 | | |
| 1JM-05-10 | 1/2"X20 | M10X1 | 14 | 8 | 29 | 14 | | |
| 1JM-05-12 | 1/2"X20 | M12X1.5 | 14 | 10 | 30 | 17 | | |
| 1JM-05-14 | 1/2"X20 | M14X1.5 | 14 | 11 | 32 | 19 | | |
| 1JM-06-12 | 9/16"X18 | M12X1.5 | 14.1 | 10 | 31 | 17 | | |
| 1JM-06-14 | 9/16"X18 | M14X1.5 | 14.1 | 11 | 33 | 19 | | |
| 1JM-06-16 | 9/16"X18 | M16X1.5 | 14.1 | 12 | 35 | 22 | | |
| 1JM-06-18 | 9/16"X18 | M18X1.5 | 14.1 | 12 | 34 | 24 | | |
| 1JM-08-16 | 3/4"X16 | M16X1.5 | 16.7 | 12 | 37.5 | 22 | | |
| 1JM-08-18 | 3/4"X16 | M18X1.5 | 16.7 | 12 | 36.5 | 24 | | |
| 1JM-08-20 | 3/4"X16 | M20X1.5 | 16.7 | 14 | 41 | 27 | | |
| 1JM-08-22 | 3/4"X16 | M22X1.5 | 16.7 | 14 | 41 | 27 | | |
| 1JM-10-20 | 7/8"X14 | M20X1.5 | 19.3 | 14 | 44 | 27 | | |
| 1JM-10-22 | 7/8"X14 | M22X1.5 | 19.3 | 14 | 43.5 | 27 | | |
| 1JM-10-26 | 7/8"X14 | M26X1.5 | 19.3 | 16 | 47.5 | 32 | | |
| 1JM-12-20 | 1.1/16"X12 | M20X1.5 | 21.9 | 14 | 47 | 30 | | |
| 1JM-12-22 | 1.1/16"X12 | M22X1.5 | 21.9 | 14 | 47 | 30 | | |
| 1JM-12-26 | 1.1/16"X12 | M26X1.5 | 21.9 | 16 | 50 | 32 | | |

注：螺母及衬套需另行订货。管子直径D为公制时，配用螺母及衬套分别选用NB200、NB500。管子直径为英制时，配用螺母及衬套分别选用NB200、NB300。 Note: Nut and sleeve should be ordered separately. The nut NB200 and sleeve NB500 is suitable for metric tube, the nut NB200 and sleeve NB300 is suitable for inch tube.

美制螺纹JIC 74° 锥面扩口接头 JIC 74° Cone Flared Tube Fittings

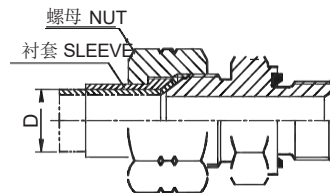
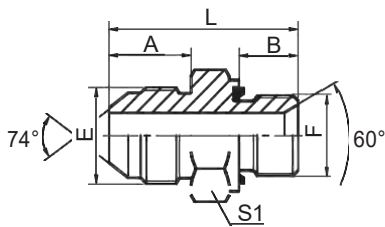

1JM-WD

JIC外螺纹74° 外锥 / 公制外螺纹胶垫密封
JIC MALE 74° CONE / METRIC MALE CAPTIVE SEAL

| 代号 PART NO. | 螺纹 THREAD | | 胶 垫 CAPTIVE | | 尺寸 DIMENSIONS | | | |
|----------------|------------|---------|-------------|--------|---------------|----|------|----|
| | E | F | | F端 | A | B | L | S1 |
| 1JM-04-10WD | 7/16"X20 | M10X1 | | WD-B02 | 14 | 8 | 29.5 | 17 |
| 1JM-04-12WD | 7/16"X20 | M12X1.5 | | WD-M12 | 14 | 12 | 34 | 17 |
| 1JM-05-14WD | 1/2"X20 | M14X1.5 | | WD-B04 | 14 | 12 | 34 | 19 |
| 1JM-06-14WD | 9/16"X18 | M14X1.5 | | WD-B04 | 14.1 | 12 | 34 | 19 |
| 1JM-06-18WD | 9/16"X18 | M18X1.5 | | WD-M18 | 14.1 | 12 | 36.5 | 24 |
| 1JM-06-20WD | 9/16"X18 | M20X1.5 | | WD-M20 | 14.1 | 14 | 40.5 | 27 |
| 1JM-08-18WD | 3/4"X16 | M18X1.5 | | WD-M18 | 16.7 | 12 | 39 | 24 |
| 1JM-08-20WD | 3/4"X16 | M20X1.5 | | WD-M20 | 16.7 | 14 | 43 | 27 |
| 1JM-08-22WD | 3/4"X16 | M22X1.5 | | WD-M22 | 16.7 | 14 | 43.5 | 27 |
| 1JM-10-18WD | 7/8"X14 | M18X1.5 | | WD-M18 | 19.3 | 12 | 41.5 | 24 |
| 1JM-10-20WD | 7/8"X14 | M20X1.5 | | WD-M20 | 19.3 | 14 | 45.5 | 27 |
| 1JM-10-22WD | 7/8"X14 | M22X1.5 | | WD-M22 | 19.3 | 14 | 46 | 27 |
| 1JM-12-20WD | 1.1/16"X12 | M20X1.5 | | WD-M20 | 21.9 | 14 | 48.5 | 30 |
| 1JM-12-22WD | 1.1/16"X12 | M22X1.5 | | WD-M22 | 21.9 | 14 | 49 | 30 |
| 1JM-12-26WD | 1.1/16"X12 | M26X1.5 | | WD-B12 | 21.9 | 16 | 52 | 32 |
| 1JM-12-27WD | 1.1/16"X12 | M27X2 | | WD-B12 | 21.9 | 16 | 52 | 32 |
| 1JM-16-26WD | 1.5/16"X12 | M26X1.5 | | WD-B12 | 23.1 | 16 | 53 | 36 |
| 1JM-16-33WD | 1.5/16"X12 | M33X2 | | WD-B16 | 23.1 | 18 | 56 | 41 |
| 1JM-20-42WD | 1.5/8"X12 | M42X2 | | WD-B20 | 24.3 | 20 | 62 | 50 |
| 1JM-20-48WD | 1.5/8"X12 | M48X2 | | WD-B24 | 24.3 | 22 | 64 | 55 |
| 1JM-24-48WD | 1.7/8"X12 | M48X2 | | WD-B24 | 27.5 | 22 | 67.5 | 55 |

注：螺母及衬套需另行订货。管子直径D为公制时，配用螺母及衬套分别选用NB200、NB500。管子直径为英制时，配用螺母及衬套分别选用NB200、NB300。Note: Nut and sleeve should be ordered separately. The nut NB200 and sleeve NB500 is suitable for metric tube, the nut NB200 and sleeve NB300 is suitable for inch tube.

H

美制螺纹JIC 74° 锥面扩口接头 JIC 74° Cone Flared Tube Fittings

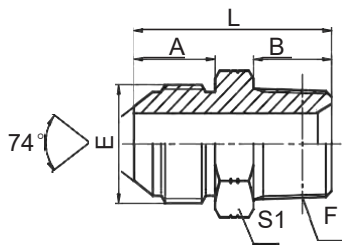

1JN

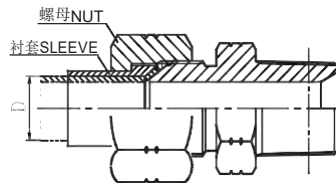

JIC外螺纹74° 外锥 / 布锥管外螺纹
JIC MALE 74° CONE / NPT MALE

| 代号 PART NO. | 螺纹 THREAD | | 尺寸 DIMENSIONS | | | | |
|----------------|------------|--------------|---------------|------|------|----|--|
| | E | F | A | B | L | S1 | |
| 1JN-02 | 5/16"X24 | Z1/8"X27 | 11.4 | 10.5 | 28 | 12 | |
| 1JN-04-02 | 7/16"X20 | Z1/8"X27 | 14 | 10.5 | 30.5 | 12 | |
| 1JN-04 | 7/16"X20 | Z1/4"X18 | 14 | 15 | 35 | 17 | |
| 1JN-04-06 | 7/16"X20 | Z3/8"X18 | 14 | 16 | 36 | 19 | |
| 1JN-04-08 | 7/16"X20 | Z1/2"X14 | 14 | 19.5 | 41.5 | 24 | |
| 1JN-05-02 | 1/2"X20 | Z1/8"X27 | 14 | 10.5 | 30.5 | 14 | |
| 1JN-05-04 | 1/2"X20 | Z1/4"X18 | 14 | 15 | 35 | 17 | |
| 1JN-05-06 | 1/2"X20 | Z3/8"X18 | 14 | 16 | 36 | 19 | |
| 1JN-05-08 | 1/2"X20 | Z1/2"X14 | 14 | 19.5 | 41.5 | 24 | |
| 1JN-06-04 | 9/16"X18 | Z1/4"X18 | 14.1 | 15 | 34.5 | 17 | |
| 1JN-06 | 9/16"X18 | Z3/8"X18 | 14.1 | 16 | 36 | 19 | |
| 1JN-06-08 | 9/16"X18 | Z1/2"X14 | 14.1 | 19.5 | 41.5 | 24 | |
| 1JN-08-04 | 3/4"X16 | Z1/4"X18 | 16.7 | 15 | 39 | 22 | |
| 1JN-08-06 | 3/4"X16 | Z3/8"X18 | 16.7 | 16 | 40 | 22 | |
| 1JN-08 | 3/4"X16 | Z1/2"X14 | 16.7 | 19.5 | 44 | 24 | |
| 1JN-08-12 | 3/4"X16 | Z3/4"X14 | 16.7 | 19.5 | 46.5 | 30 | |
| 1JN-10-06 | 7/8"X14 | Z3/8"X18 | 19.3 | 16 | 43.5 | 24 | |
| 1JN-10-08 | 7/8"X14 | Z1/2"X14 | 19.3 | 19.5 | 47 | 24 | |
| 1JN-10-12 | 7/8"X14 | Z3/4"X14 | 19.3 | 19.5 | 49 | 30 | |
| 1JN-12-08 | 1.1/16"X12 | Z1/2"X14 | 21.9 | 19.5 | 51 | 30 | |
| 1JN-12 | 1.1/16"X12 | Z3/4"X14 | 21.9 | 19.5 | 51.5 | 30 | |
| 1JN-12-16 | 1.1/16"X12 | Z1"X11.5 | 21.9 | 25.5 | 58.5 | 36 | |
| 1JN-12-20 | 1.1/16"X12 | Z1.1/4"X11.5 | 21.9 | 26.5 | 61.5 | 46 | |
| 1JN-14-12 | 1.3/16"X12 | Z3/4"X14 | 22.6 | 19.5 | 53 | 32 | |
| 1JN-16-12 | 1.5/16"X12 | Z3/4"X14 | 23.1 | 19.5 | 53.5 | 36 | |
| 1JN-16 | 1.5/16"X12 | Z1"X11.5 | 23.1 | 25.5 | 58.5 | 36 | |
| 1JN-16-20 | 1.5/16"X12 | Z1.1/4"X11.5 | 23.1 | 26.5 | 62.5 | 46 | |
| 1JN-16-24 | 1.5/16"X12 | Z1.1/2"X11.5 | 23.1 | 27.5 | 65.5 | 50 | |
| 1JN-20-16 | 1.5/8"X12 | Z1"X11.5 | 24.3 | 25.5 | 63 | 46 | |
| 1JN-20 | 1.5/8"X12 | Z1.1/4"X11.5 | 24.3 | 26.5 | 63.5 | 46 | |
| 1JN-20-24 | 1.5/8"X12 | Z1.1/2"X11.5 | 24.3 | 27.5 | 67 | 50 | |
| 1JN-24-20 | 1.7/8"X12 | Z1.1/4"X11.5 | 27.5 | 26.5 | 69 | 50 | |
| 1JN-24 | 1.7/8"X12 | Z1.1/2"X11.5 | 27.5 | 27.5 | 69 | 50 | |
| 1JN-24-32 | 1.7/8"X12 | Z2"X11.5 | 27.5 | 27.5 | 72 | 65 | |
| 1JN-32 | 2.1/2"X12 | Z2"X11.5 | 33.9 | 27.5 | 78.5 | 65 | |
| 1JN-32-20 | 2.1/2"X12 | Z1.1/4"X11.5 | 33.9 | 26.5 | 77.5 | 65 | |
| 1JN-32-24 | 2.1/2"X12 | Z1.1/2"X11.5 | 33.9 | 27.5 | 78.5 | 65 | |

注：螺母及衬套需另行订货。管子直径D为公制时，配用螺母及衬套分别选用NB200、NB500。管子直径为英制时，配用螺母及衬套分别选用NB200、NB300。Note: Nut and sleeve should be ordered separately. The nut NB200 and sleeve NB500 is suitable for metric tube, the nut NB200 and sleeve NB300 is suitable for inch tube.

美制螺纹JIC 74° 锥面扩口接头 JIC 74° Cone Flared Tube Fittings

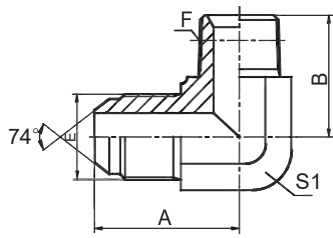

1JN9

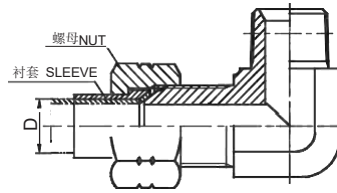

90° 弯 JIC外螺纹74° 外锥 / 布锥管外螺纹
90° ELBOW JIC MALE 74° CONE / NPT MALE

| 代号 PART NO. | 螺纹 THREAD | | 尺寸 DIMENSIONS | | | |
|----------------|------------|--------------|---------------|------|----|--|
| | E | F | A | B | S1 | |
| 1JN9-02 | 5/16"X24 | Z1/8"X27 | 21 | 21 | 11 | |
| 1JN9-03-02 | 3/8"X24 | Z1/8"X27 | 22 | 21 | 11 | |
| 1JN9-04 | 7/16"X20 | Z1/4"X18 | 26.6 | 25.5 | 14 | |
| 1JN9-04-02 | 7/16"X20 | Z1/8"X27 | 24.5 | 21 | 11 | |
| 1JN9-04-06 | 7/16"X20 | Z3/8"X18 | 29.5 | 31 | 19 | |
| 1JN9-05-02 | 1/2"X20 | Z1/8"X27 | 26.6 | 23.5 | 14 | |
| 1JN9-05-04 | 1/2"X20 | Z1/4"X18 | 26.6 | 25.5 | 14 | |
| 1JN9-05-06 | 1/2"X20 | Z3/8"X18 | 29.5 | 31 | 19 | |
| 1JN9-06 | 9/16"X18 | Z3/8"X18 | 30 | 31 | 19 | |
| 1JN9-06-04 | 9/16"X18 | Z1/4"X18 | 26.9 | 25.5 | 14 | |
| 1JN9-06-08 | 9/16"X18 | Z1/2"X14 | 32 | 36.7 | 22 | |
| 1JN9-08 | 3/4"X16 | Z1/2"X14 | 34.8 | 37.3 | 22 | |
| 1JN9-08-04 | 3/4"X16 | Z1/4"X18 | 32 | 28.5 | 19 | |
| 1JN9-08-06 | 3/4"X16 | Z3/8"X18 | 32 | 31 | 19 | |
| 1JN9-08-12 | 3/4"X16 | Z3/4"X14 | 37.9 | 44 | 27 | |
| 1JN9-10-06 | 7/8"X14 | Z3/8"X18 | 37.8 | 32.5 | 22 | |
| 1JN9-10-08 | 7/8"X14 | Z1/2"X14 | 37.8 | 37.3 | 22 | |
| 1JN9-10-12 | 7/8"X14 | Z3/4"X14 | 41 | 44 | 27 | |
| 1JN9-10-16 | 7/8"X14 | Z1"X11.5 | 44.5 | 50 | 33 | |
| 1JN9-12 | 1.1/16"X12 | Z3/4"X14 | 44.2 | 44 | 27 | |
| 1JN9-12-08 | 1.1/16"X12 | Z1/2"X14 | 44.2 | 40 | 27 | |
| 1JN9-12-16 | 1.1/16"X12 | Z1"X11.5 | 49 | 50 | 33 | |
| 1JN9-12-20 | 1.1/16"X12 | Z1.1/4"X11.5 | 52.5 | 54.5 | 41 | |
| 1JN9-14-12 | 1.3/16"X12 | Z3/4"X14 | 47.5 | 45 | 30 | |
| 1JN9-14-16 | 1.3/16"X12 | Z1"X11.5 | 48.7 | 50 | 33 | |
| 1JN9-16 | 1.5/16"X12 | Z1"X11.5 | 49 | 50 | 33 | |
| 1JN9-16-12 | 1.5/16"X12 | Z3/4"X14 | 49 | 45.2 | 33 | |
| 1JN9-16-20 | 1.5/16"X12 | Z1.1/4"X11.5 | 54 | 60.5 | 41 | |
| 1JN9-16-24 | 1.5/16"X12 | Z1.1/2"X11.5 | 58 | 63 | 48 | |
| 1JN9-20 | 1.5/8"X12 | Z1.1/4"X11.5 | 55.5 | 54.5 | 41 | |
| 1JN9-20-16 | 1.5/8"X12 | Z1"X11.5 | 55.5 | 59.6 | 41 | |
| 1JN9-20-24 | 1.5/8"X12 | Z1.1/2"X11.5 | 59.4 | 63 | 48 | |
| 1JN9-24 | 1.7/8"X12 | Z1.1/2"X11.5 | 62.5 | 63 | 48 | |
| 1JN9-24-20 | 1.7/8"X12 | Z1.1/4"X11.5 | 62.5 | 63 | 48 | |
| 1JN9-32-24 | 2.1/2"X12 | Z1.1/2"X11.5 | 75.4 | 67.5 | 63 | |
| 1JN9-32 | 2.1/2"X12 | Z2"X11.5 | 75.4 | 67.5 | 63 | |

注：螺母及衬套需另行订货。管子直径 D为公制时，配用螺母及衬套分别选用 NB200、NB500。管子直径为英制时，配用螺母及衬套分别选用 NB200、NB300。 Note : Nut and sleeve should be ordered separately. The nut NB200 and sleeve NB500 is suitable for metric tube, the nut NB200 and sleeve NB300 is suitable for inch tube.

H

美制螺纹JIC 74° 锥面扩口接头 JIC 74° Cone Flared Tube Fittings

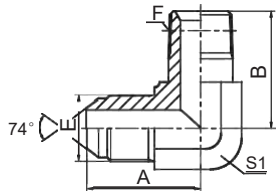

1JN9-L

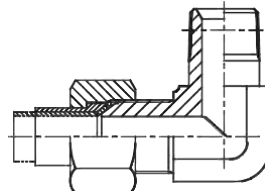

90° JIC外螺纹74° 外锥 / 加长布锥管外螺纹
90° JIC MALE 74° CONE / LONG NPT MALE

| 代号 PART NO. | 螺 纹 THREAD | | 尺 寸 DIMENSIONS | | | |
|----------------|------------|--------------|----------------|-------|----|--|
| | E | F | A | B | S1 | |
| 1JN9-04-02L | 7/16"X20 | Z1/8"X27 | 24.5 | 30 | 11 | |
| 1JN9-04L | 7/16"X20 | Z1/4"X18 | 26.6 | 40.1 | 14 | |
| 1JN9-05-02L | 1/2"X20 | Z1/8"X27 | 26.6 | 31 | 14 | |
| 1JN9-05-04L | 1/2"X20 | Z1/4"X18 | 26.6 | 40.1 | 14 | |
| 1JN9-06-04L | 9/16"X18 | Z1/4"X18 | 26.9 | 40.1 | 14 | |
| 1JN9-06-08L | 9/16"X18 | Z1/2"X14 | 32 | 55.1 | 22 | |
| 1JN9-08-06L | 3/4"X16 | Z3/8"X18 | 32 | 46.2 | 19 | |
| 1JN9-08L | 3/4"X16 | Z1/2"X14 | 34.8 | 55.1 | 22 | |
| 1JN9-10-08L | 7/8"X14 | Z1/2"X14 | 37.8 | 55.1 | 22 | |
| 1JN9-12-08L | 1.1/16"X12 | Z1/2"X14 | 44.2 | 56.9 | 27 | |
| 1JN9-12L | 1.1/16"X12 | Z3/4"X14 | 44.2 | 62 | 27 | |
| 1JN9-16-12L | 1.5/16"X12 | Z3/4"X14 | 49 | 69.9 | 33 | |
| 1JN9-16L | 1.5/16"X12 | Z1"X11.5 | 49 | 76.5 | 33 | |
| 1JN9-20L | 1.5/8"X12 | Z1.1/4"X11.5 | 55.5 | 93.7 | 41 | |
| 1JN9-24L | 1.7/8"X12 | Z1.1/2"X11.5 | 62.5 | 104.1 | 48 | |
| 1JN9-32L | 2.1/2"X12 | Z2"X11.5 | 78 | 122.2 | 63 | |

注：螺母及衬套需另行订货。管子直径D为公制时，配用螺母及衬套分别选用NB200、NB500。管子直径为英制时，配用螺母及衬套分别选用NB200、NB300。 Note: Nut and sleeve should be ordered separately. The nut NB200 and sleeve NB500 is suitable for metric tube, the nut NB200 and sleeve NB300 is suitable for inch tube.

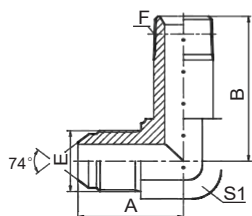

1JN9-LL

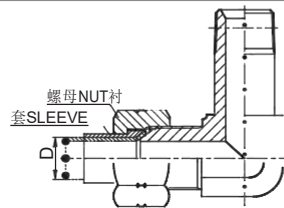

90° 弯 JIC外螺纹74° 外锥 / 加长布锥管外螺纹
90° ELBOW JIC MALE 74° CONE / LONGER NPT MALE

| 代号 PART NO. | 螺 纹 THREAD | | 尺 寸 DIMENSIONS | | | |
|----------------|------------|--------------|----------------|-------|----|--|
| | E | F | A | B | S1 | |
| 1JN9-04-02LL | 7/16"X20 | Z1/8"X27 | 24.5 | 39.6 | 11 | |
| 1JN9-04LL | 7/16"X20 | Z1/4"X18 | 26.6 | 52.6 | 14 | |
| 1JN9-05-04LL | 1/2"X20 | Z1/4"X18 | 26.6 | 52.6 | 14 | |
| 1JN9-06-04LL | 9/16"X18 | Z1/4"X18 | 26.9 | 52.6 | 14 | |
| 1JN9-06LL | 9/16"X18 | Z3/8"X18 | 30 | 61.5 | 19 | |
| 1JN9-08-06LL | 3/4"X16 | Z3/8"X18 | 32 | 61.5 | 19 | |
| 1JN9-10-08LL | 7/8"X14 | Z1/2"X14 | 37.8 | 72.9 | 22 | |
| 1JN9-12LL | 1.1/16"X12 | Z3/4"X14 | 44.2 | 83.3 | 27 | |
| 1JN9-16LL | 1.5/16"X12 | Z1"X11.5 | 49 | 102.9 | 33 | |
| 1JN9-20LL | 1.5/8"X12 | Z1.1/4"X11.5 | 55.5 | 127 | 41 | |
| 1JN9-24LL | 1.7/8"X12 | Z1.1/2"X11.5 | 62.5 | 141 | 48 | |
| 1JN9-32LL | 2.1/2"X12 | Z2"X11.5 | 78 | 168.4 | 63 | |

注：螺母及衬套需另行订货。管子直径D为公制时，配用螺母及衬套分别选用NB200、NB500。管子直径为英制时，配用螺母及衬套分别选用NB200、NB300。 Note: Nut and sleeve should be ordered separately. The nut NB200 and sleeve NB500 is suitable for metric tube, the nut NB200 and sleeve NB300 is suitable for inch tube.

美制螺纹JIC 74° 锥面扩口接头 JIC 74° Cone Flared Tube Fittings

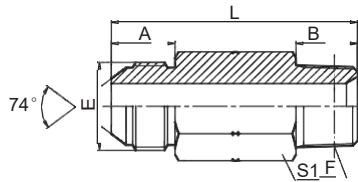

1JN-L

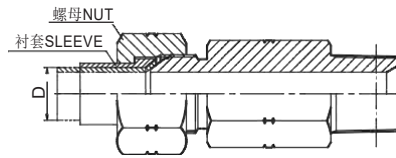

JIC外螺纹74° 外锥 / 布锥管外螺纹加长
JIC MALE 74° CONE / NPT MALE LONG

| 代号 PART NO. | 螺 纹 THREAD | | 尺 寸 DIMENSIONS | | | | | |
|----------------|------------|--------------|----------------|------|-------|----|--|--|
| | E | F | A | B | L | S1 | | |
| 1JN-04-02L | 7/16"X20 | Z1/8"X27 | 14 | 10.5 | 46 | 12 | | |
| 1JN-04L | 7/16"X20 | Z1/4"X18 | 14 | 15 | 57.2 | 17 | | |
| 1JN-05-02L | 1/2"X20 | Z1/8"X27 | 14 | 10.5 | 49.2 | 14 | | |
| 1JN-05-04L | 1/2"X20 | Z1/4"X18 | 14 | 15 | 57.2 | 17 | | |
| 1JN-06-02L | 9/16"X18 | Z1/8"X27 | 14.1 | 10.5 | 56 | 17 | | |
| 1JN-06-04L | 9/16"X18 | Z1/4"X18 | 14.1 | 15 | 57.2 | 17 | | |
| 1JN-06L | 9/16"X18 | Z3/8"X18 | 14.1 | 16 | 63.5 | 19 | | |
| 1JN-06-08L | 9/16"X18 | Z1/2"X14 | 14.1 | 19.5 | 74.8 | 24 | | |
| 1JN-08-04L | 3/4"X16 | Z1/4"X18 | 16.7 | 15 | 69.8 | 22 | | |
| 1JN-08-06L | 3/4"X16 | Z3/8"X18 | 16.7 | 16 | 69.8 | 22 | | |
| 1JN-08L | 3/4"X16 | Z1/2"X14 | 16.7 | 19.5 | 77.2 | 24 | | |
| 1JN-10-08L | 7/8"X14 | Z1/2"X14 | 19.3 | 19.5 | 79.4 | 24 | | |
| 1JN-12L | 1.1/16"X12 | Z3/4"X14 | 21.9 | 19.5 | 88.9 | 30 | | |
| 1JN-16-12L | 1.5/16"X12 | Z3/4"X14 | 23.1 | 19.5 | 96.7 | 36 | | |
| 1JN-16L | 1.5/16"X12 | Z1"X11.5 | 23.1 | 25.5 | 101.6 | 36 | | |
| 1JN-20L | 1.5/8"X12 | Z1.1/4"X11.5 | 24.3 | 26.5 | 114.3 | 46 | | |
| 1JN-24L | 1.7/8"X12 | Z1.1/2"X11.5 | 27.5 | 27.5 | 124 | 50 | | |
| 1JN-32L | 2.1/2"X12 | Z2"X11.5 | 33.9 | 27.5 | 142.7 | 65 | | |

注：螺母及衬套需另行订货。管子直径D为公制时，配用螺母及衬套分别选用NB200、NB500。管子直径为英制时，配用螺母及衬套分别选用NB200、NB300。Nut and sleeve should be ordered separately. The nut NB200 and sleeve NB500 is suitable for metric tube, the nut NB200 and sleeve NB300 is suitable for inch tube.

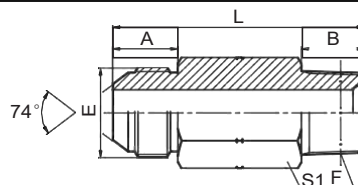

1JN-LL

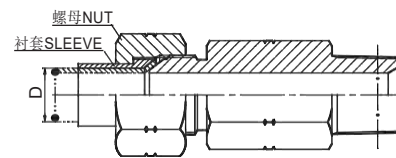

JIC外螺纹74° 外锥 / 布锥管外螺纹加长
JIC MALE 74° CONE / NPT MALE EXTRA LONG

| 代号 PART NO. | 螺 纹 THREAD | | 尺 寸 DIMENSIONS | | | | | |
|----------------|------------|----------|----------------|------|-------|----|--|--|
| | E | F | A | B | L | S1 | | |
| 1JN-04-02LL | 7/16"X20 | Z1/8"X27 | 14 | 10.5 | 65 | 12 | | |
| 1JN-04LL | 7/16"X20 | Z1/4"X18 | 14 | 15 | 82.6 | 17 | | |
| 1JN-05-02LL | 1/2"X20 | Z1/8"X27 | 14 | 10.5 | 71.4 | 14 | | |
| 1JN-06-04LL | 9/16"X18 | Z1/4"X18 | 14.1 | 15 | 82.5 | 17 | | |
| 1JN-06LL | 9/16"X18 | Z3/8"X18 | 14.1 | 16 | 99.6 | 19 | | |
| 1JN-08-06LL | 3/4"X16 | Z3/8"X18 | 16.7 | 16 | 101.6 | 22 | | |
| 1JN-08LL | 3/4"X16 | Z1/2"X14 | 16.7 | 19.5 | 106.6 | 24 | | |
| 1JN-10-08LL | 7/8"X14 | Z1/2"X14 | 19.3 | 19.5 | 111.1 | 24 | | |
| 1JN-12LL | 1.1/16"X12 | Z3/4"X14 | 21.9 | 19.5 | 127 | 30 | | |
| 1JN-16LL | 1.5/16"X12 | Z1"X11.5 | 23.1 | 25.5 | 171.4 | 36 | | |

注：螺母及衬套需另行订货。管子直径D为公制时，配用螺母及衬套分别选用NB200、NB500。管子直径为英制时，配用螺母及衬套分别选用NB200、NB300。Nut and sleeve should be ordered separately. The nut NB200 and sleeve NB500 is suitable for metric tube, the nut NB200 and sleeve NB300 is suitable for inch tube.

美制螺纹JIC 74° 锥面扩口接头 JIC 74° Cone Flared Tube Fittings

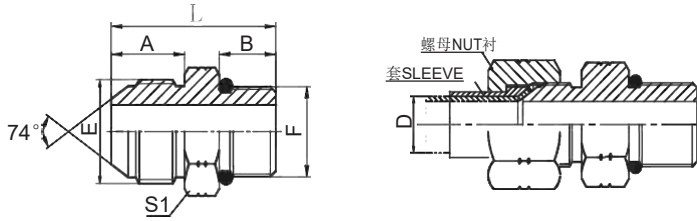

1JO

美制JIC外螺纹74° 外锥 / SAE
外螺纹带O形圈轻系列ISO 11926-3
JIC MALE 74° CONE / SAE
O-RING BOSS L-SERIES ISO 11926-3

| 代号 PART NO. | 螺纹 THREAD | | O 形 圈 O-RING | | 尺 寸 DIMENSIONS | | | | |
|----------------|------------|------------|--------------|------|----------------|-------|------|-----|--|
| | E | F | | F 端 | A | B | L | S 1 | |
| 1JO-04-02 | 7/16"X20 | 5/16"X24 | | O902 | 14 | 7.54 | 27.5 | 14 | |
| 1JO-04-03 | 7/16"X20 | 3/8"X24 | | O903 | 14 | 7.54 | 27.5 | 14 | |
| 1JO-04 | 7/16"X20 | 7/16"X20 | | O904 | 14 | 9.14 | 29 | 14 | |
| 1JO-04-05 | 7/16"X20 | 1/2"X20 | | O905 | 14 | 9.14 | 29 | 17 | |
| 1JO-04-06 | 7/16"X20 | 9/16"X18 | | O906 | 14 | 9.93 | 30 | 17 | |
| 1JO-04-08 | 7/16"X20 | 3/4"X16 | | O908 | 14 | 11.13 | 33 | 22 | |
| 1JO-05 | 1/2"X20 | 1/2"X20 | | O905 | 14 | 9.14 | 29 | 17 | |
| 1JO-05-04 | 1/2"X20 | 7/16"X20 | | O904 | 14 | 9.14 | 29 | 14 | |
| 1JO-05-06 | 1/2"X20 | 9/16"X18 | | O906 | 14 | 9.93 | 30 | 17 | |
| 1JO-05-08 | 1/2"X20 | 3/4"X16 | | O908 | 14 | 11.13 | 33 | 22 | |
| 1JO-06 | 9/16"X18 | 9/16"X18 | | O906 | 14.1 | 9.93 | 30 | 17 | |
| 1JO-06-04 | 9/16"X18 | 7/16"X20 | | O904 | 14.1 | 9.14 | 29 | 17 | |
| 1JO-06-05 | 9/16"X18 | 1/2"X20 | | O905 | 14.1 | 9.14 | 29.5 | 17 | |
| 1JO-06-08 | 9/16"X18 | 3/4"X16 | | O908 | 14.1 | 11.13 | 33 | 22 | |
| 1JO-06-10 | 9/16"X18 | 7/8"X14 | | O910 | 14.1 | 12.7 | 37 | 27 | |
| 1JO-06-12 | 9/16"X18 | 1.1/16"X12 | | O912 | 14.1 | 15.09 | 40 | 32 | |
| 1JO-08 | 3/4"X16 | 3/4"X16 | | O908 | 16.7 | 11.13 | 36 | 22 | |
| 1JO-08-04 | 3/4"X16 | 7/16"X20 | | O904 | 16.7 | 9.14 | 36 | 22 | |
| 1JO-08-06 | 3/4"X16 | 9/16"X18 | | O906 | 16.7 | 9.93 | 37 | 22 | |
| 1JO-08-10 | 3/4"X16 | 7/8"X14 | | O910 | 16.7 | 12.7 | 40 | 27 | |
| 1JO-08-12 | 3/4"X16 | 1.1/16"X12 | | O912 | 16.7 | 15.09 | 43 | 32 | |
| 1JO-08-14 | 3/4"X16 | 1.3/16"X12 | | O914 | 16.7 | 15.09 | 43 | 36 | |
| 1JO-10 | 7/8"X14 | 7/8"X14 | | O910 | 19.3 | 12.7 | 42.5 | 27 | |
| 1JO-10-08 | 7/8"X14 | 3/4"X16 | | O908 | 19.3 | 11.13 | 39 | 24 | |
| 1JO-10-12 | 7/8"X14 | 1.1/16"X12 | | O912 | 19.3 | 15.09 | 45.5 | 32 | |
| 1JO-10-14 | 7/8"X14 | 1.3/16"X12 | | O914 | 19.3 | 15.09 | 45.5 | 36 | |
| 1JO-12 | 1.1/16"X12 | 1.1/16"X12 | | O912 | 21.9 | 15.09 | 48 | 32 | |
| 1JO-12-08 | 1.1/16"X12 | 3/4"X16 | | O908 | 21.9 | 11.13 | 46 | 30 | |
| 1JO-12-10 | 1.1/16"X12 | 7/8"X14 | | O910 | 21.9 | 12.7 | 48 | 30 | |
| 1JO-12-14 | 1.1/16"X12 | 1.3/16"X12 | | O914 | 21.9 | 15.09 | 48 | 36 | |
| 1JO-12-16 | 1.1/16"X12 | 1.5/16"X12 | | O916 | 21.9 | 15.09 | 48 | 38 | |
| 1JO-14 | 1.3/16"X12 | 1.3/16"X12 | | O914 | 22.6 | 15.09 | 48.5 | 36 | |
| 1JO-14-12 | 1.3/16"X12 | 1.1/16"X12 | | O912 | 22.6 | 15.09 | 48.5 | 32 | |
| 1JO-14-16 | 1.3/16"X12 | 1.5/16"X12 | | O916 | 22.6 | 15.09 | 50.5 | 38 | |
| 1JO-16 | 1.5/16"X12 | 1.5/16"X12 | | O916 | 23.1 | 15.09 | 49 | 38 | |
| 1JO-16-12 | 1.5/16"X12 | 1.1/16"X12 | | O912 | 23.1 | 15.09 | 52.5 | 36 | |
| 1JO-16-14 | 1.5/16"X12 | 1.3/16"X12 | | O914 | 23.1 | 15.09 | 49 | 36 | |
| 1JO-16-20 | 1.5/16"X12 | 1.5/8"X12 | | O920 | 23.1 | 15.09 | 53 | 50 | |
| 1JO-20 | 1.5/8"X12 | 1.5/8"X12 | | O920 | 24.3 | 15.09 | 54.5 | 50 | |
| 1JO-20-16 | 1.5/8"X12 | 1.5/16"X12 | | O916 | 24.3 | 15.09 | 56.5 | 46 | |
| 1JO-20-24 | 1.5/8"X12 | 1.7/8"X12 | | O924 | 24.3 | 15.09 | 54.5 | 55 | |
| 1JO-24 | 1.7/8"X12 | 1.7/8"X12 | | O924 | 27.5 | 15.09 | 57.5 | 55 | |
| 1JO-24-20 | 1.7/8"X12 | 1.5/8"X12 | | O920 | 27.5 | 15.09 | 61.5 | 50 | |
| 1JO-24-32 | 1.7/8"X12 | 2.1/2"X12 | | O932 | 27.5 | 15.09 | 59.5 | 70 | |
| 1JO-32 | 2.1/2"X12 | 2.1/2"X12 | | O932 | 33.9 | 15.09 | 66 | 70 | |

注：螺母及衬套需另行订货。管子直径D为公制时，配用螺母及衬套分别选用NB200、NB500。管子直径为英制时，配用螺母及衬套分别选NB200、NB300。Note: Nut and sleeve should be ordered separately. The nut NB200 and sleeve NB500 is suitable for metric tube, the nut NB200 and sleeve NB300 is suitable for inch tube.

美制螺纹JIC 74° 锥面扩口接头 JIC 74° Cone Flared Tube Fittings

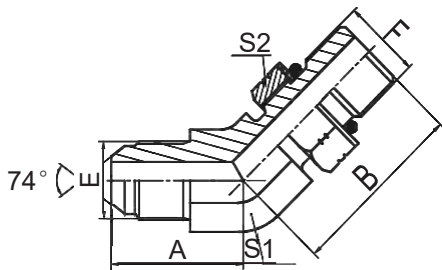

1JO4-OG

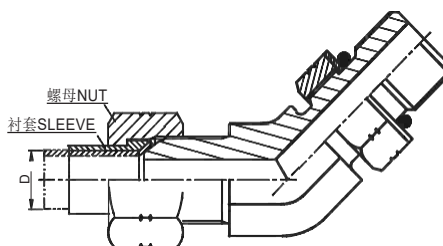

45° 弯JIC外螺纹74° 外锥 / SAE外螺纹带O形圈轻
系列ISO 11926-3

45° ELBOW JIC MALE 74° CONE / SAE O-RING
BOSS L-SERIES ISO 11926-3

| 代号 PART NO. | 螺纹 THREAD | | O形圈 O-RING | | 尺寸 DIMENSIONS | | | | |
|----------------|------------|------------|------------|------|---------------|------|----|----|--|
| | E | F | | F端 | A | B | S1 | S2 | |
| 1JO4-04OG | 7/16"X20 | 7/16"X20 | | O904 | 21 | 24 | 11 | 17 | |
| 1JO4-04-06OG | 7/16"X20 | 9/16"X18 | | O906 | 22.3 | 27.5 | 14 | 19 | |
| 1JO4-04-08OG | 7/16"X20 | 3/4"X16 | | O908 | 23.5 | 31.5 | 19 | 24 | |
| 1JO4-05OG | 1/2"X20 | 1/2"X20 | | O905 | 22 | 26.7 | 14 | 17 | |
| 1JO4-05-04OG | 1/2"X20 | 7/16"X20 | | O904 | 22.3 | 26 | 14 | 17 | |
| 1JO4-06OG | 9/16"X18 | 9/16"X18 | | O906 | 23.5 | 28 | 14 | 19 | |
| 1JO4-06-04OG | 9/16"X18 | 7/16"X20 | | O904 | 22.8 | 26 | 14 | 17 | |
| 1JO4-06-05OG | 9/16"X18 | 1/2"X20 | | O905 | 22.8 | 26.5 | 14 | 17 | |
| 1JO4-06-08OG | 9/16"X18 | 3/4"X16 | | O908 | 25 | 32.5 | 19 | 24 | |
| 1JO4-06-10OG | 9/16"X18 | 7/8"X14 | | O910 | 25.5 | 38.5 | 22 | 27 | |
| 1JO4-08OG | 3/4"X16 | 3/4"X16 | | O908 | 25.8 | 32.5 | 19 | 24 | |
| 1JO4-08-06OG | 3/4"X16 | 9/16"X18 | | O906 | 25.5 | 28 | 19 | 19 | |
| 1JO4-08-10OG | 3/4"X16 | 7/8"X14 | | O910 | 28 | 38.7 | 22 | 27 | |
| 1JO4-08-12OG | 3/4"X16 | 1.1/16"X12 | | O912 | 30 | 43.9 | 27 | 32 | |
| 1JO4-10OG | 7/8"X14 | 7/8"X14 | | O910 | 29.5 | 38.7 | 22 | 27 | |
| 1JO4-10-08OG | 7/8"X14 | 3/4"X16 | | O908 | 29.5 | 33 | 22 | 27 | |
| 1JO4-10-12OG | 7/8"X14 | 1.1/16"X12 | | O912 | 33 | 43.9 | 27 | 32 | |
| 1JO4-12OG | 1.1/16"X12 | 1.1/16"X12 | | O912 | 34 | 43.5 | 27 | 32 | |
| 1JO4-12-10OG | 1.1/16"X12 | 7/8"X14 | | O910 | 34 | 42 | 27 | 27 | |
| 1JO4-12-16OG | 1.1/16"X12 | 1.5/16"X12 | | O916 | 37 | 45.5 | 33 | 41 | |
| 1JO4-14OG | 1.3/16"X12 | 1.3/16"X12 | | O914 | 37 | 44 | 30 | 36 | |
| 1JO4-16OG | 1.5/16"X12 | 1.5/16"X12 | | O916 | 38 | 45.5 | 33 | 41 | |
| 1JO4-16-12OG | 1.5/16"X12 | 1.1/16"X12 | | O912 | 38 | 45 | 33 | 32 | |
| 1JO4-16-20OG | 1.5/16"X12 | 1.5/8"X12 | | O920 | 40.5 | 47 | 41 | 50 | |
| 1JO4-20OG | 1.5/8"X12 | 1.5/8"X12 | | O920 | 42 | 48.5 | 41 | 50 | |
| 1JO4-20-24OG | 1.5/8"X12 | 1.7/8"X12 | | O924 | 46 | 50 | 48 | 55 | |
| 1JO4-24OG | 1.7/8"X12 | 1.7/8"X12 | | O924 | 48 | 50 | 48 | 55 | |
| 1JO4-32OG | 2.1/2"X12 | 2.1/2"X12 | | O932 | 58 | 54 | 63 | 70 | |

注：1螺母及衬套需另行订货。管子直径D为公制时，配用螺母及衬套分别选用NB200、NB500。管子直径为英制时，配用螺母及衬套分别选用NB200、NB300。 2 F端与ISO 11926-1油口相配。Note: 1 Nut and sleeve should be ordered separately. The nut NB200 and sleeve NB500 is suitable for metric tube, the nut NB200 and sleeve NB300 is suitable for inch tube. 2 F end is connected with ISO 11926-1 port.

H

美制螺纹JIC 74° 锥面扩口接头 JIC 74° Cone Flared Tube Fittings

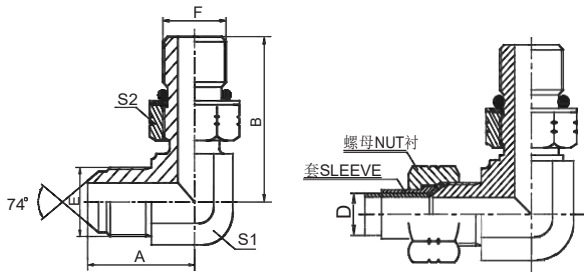

90° 弯美制JIC外螺纹74° 外
 锥 / SAE外螺纹带O形圈轻系列ISO 11926-3
 90° ELBOW JIC MALE 74°
 CONE / SAE O-RING BOSS L-SERIES ISO 11926-3

1JO9-OG

| 代号 PART NO. | 螺 纹 THREAD | | O形圈 O-RING | 尺 寸 DIMENSIONS | | | | |
|----------------|------------|------------|------------|----------------|------|----|----|--|
| | E | F | F端 | A | B | S1 | S2 | |
| 1JO9-04-03OG | 7/16"X20 | 3/8"X24 | O903 | 24.5 | 28 | 11 | 14 | |
| 1JO9-04OG | 7/16"X20 | 7/16"X20 | O904 | 24.5 | 27.2 | 11 | 17 | |
| 1JO9-04-05OG | 7/16"X20 | 1/2"X20 | O905 | 26.6 | 29.9 | 14 | 17 | |
| 1JO9-04-06OG | 7/16"X20 | 9/16"X18 | O906 | 26.6 | 31.8 | 14 | 19 | |
| 1JO9-05-04OG | 1/2"X20 | 7/16"X20 | O904 | 26.6 | 30 | 14 | 17 | |
| 1JO9-05OG | 1/2"X20 | 1/2"X20 | O905 | 26.6 | 29 | 14 | 17 | |
| 1JO9-05-06OG | 1/2"X20 | 9/16"X18 | O906 | 26.6 | 31.8 | 14 | 19 | |
| 1JO9-06-04OG | 9/16"X18 | 7/16"X20 | O904 | 26.9 | 30 | 14 | 17 | |
| 1JO9-06-05OG | 9/16"X18 | 1/2"X20 | O905 | 26.9 | 29.9 | 14 | 17 | |
| 1JO9-06OG | 9/16"X18 | 9/16"X18 | O906 | 26.9 | 31.8 | 14 | 19 | |
| 1JO9-06-08OG | 9/16"X18 | 3/4"X16 | O908 | 30 | 36.8 | 19 | 24 | |
| 1JO9-08-04OG | 3/4"X16 | 7/16"X20 | O904 | 32 | 33 | 19 | 17 | |
| 1JO9-08-06OG | 3/4"X16 | 9/16"X18 | O906 | 33 | 33.5 | 19 | 19 | |
| 1JO9-08OG | 3/4"X16 | 3/4"X16 | O908 | 33 | 36.8 | 19 | 24 | |
| 1JO9-08-10OG | 3/4"X16 | 7/8"X14 | O910 | 34.8 | 44 | 22 | 27 | |
| 1JO9-08-12OG | 3/4"X16 | 1.1/16"X12 | O912 | 37.9 | 51 | 27 | 32 | |
| 1JO9-10-08OG | 7/8"X14 | 3/4"X16 | O908 | 38 | 40 | 22 | 27 | |
| 1JO9-10OG | 7/8"X14 | 7/8"X14 | O910 | 37.8 | 44 | 22 | 27 | |
| 1JO9-10-12OG | 7/8"X14 | 1.1/16"X12 | O912 | 41 | 51 | 27 | 32 | |
| 1JO9-12-08OG | 1.1/16"X12 | 3/4"X16 | O908 | 45 | 44 | 27 | 24 | |
| 1JO9-12-10OG | 1.1/16"X12 | 7/8"X14 | O910 | 44.2 | 47 | 27 | 27 | |
| 1JO9-12OG | 1.1/16"X12 | 1.1/16"X12 | O912 | 44.2 | 51 | 27 | 32 | |
| 1JO9-12-16OG | 1.1/16"X12 | 1.5/16"X12 | O916 | 47.8 | 54.5 | 33 | 41 | |
| 1JO9-14OG | 1.3/16"X12 | 1.3/16"X12 | O914 | 47.5 | 53 | 30 | 36 | |
| 1JO9-14-16OG | 1.3/16"X12 | 1.5/16"X12 | O916 | 48.5 | 54.5 | 33 | 41 | |
| 1JO9-16-12OG | 1.5/16"X12 | 1.1/16"X12 | O912 | 48.8 | 54.5 | 33 | 32 | |
| 1JO9-16-14OG | 1.5/16"X12 | 1.3/16"X12 | O914 | 49 | 56 | 33 | 36 | |
| 1JO9-16OG | 1.5/16"X12 | 1.5/16"X12 | O916 | 48.8 | 54.5 | 33 | 41 | |
| 1JO9-16-20OG | 1.5/16"X12 | 1.5/8"X12 | O920 | 53.8 | 59 | 41 | 50 | |
| 1JO9-20-16OG | 1.5/8"X12 | 1.5/16"X12 | O916 | 55.5 | 59.5 | 41 | 41 | |
| 1JO9-20OG | 1.5/8"X12 | 1.5/8"X12 | O920 | 55.3 | 59 | 41 | 50 | |
| 1JO9-20-24OG | 1.5/8" X12 | 1.7/8"X12 | O924 | 59.4 | 63 | 48 | 55 | |
| 1JO9-24OG | 1.7/8"X12 | 1.7/8"X12 | O924 | 62.5 | 63 | 48 | 55 | |
| 1JO9-32OG | 2.1/2"x12 | 2.1/2"x12 | O932 | 80 | 76 | 63 | 70 | |

注： 1螺母及衬套需另行订货。管子直径D为公制时，配用螺母及衬套分别选用NB200、NB500。管子直径为英制时，配用螺母及衬套分别选用NB200、NB300。2 F端与ISO 11926-1油口相配。 Note: 1 Nut and sleeve should be ordered separately.The nut NB200 and sleeve NB500 is suitable for metric tube,the nut NB200 and sleeve NB300 is suitable for inch tube. 2 F end is connected with ISO 11926-1 port.

美制螺纹JIC 74° 锥面扩口接头 JIC 74° Cone Flared Tube Fittings

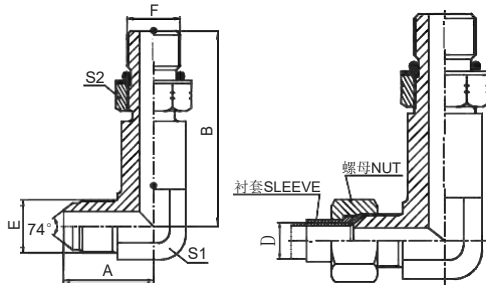

1JO9-OG/L

90° 美制JIC外螺纹 / 加长
SAE外螺纹带O形圈轻系列ISO 11926-3
90° JIC MALE / LONG SAE
O-RING BOSS L-SERIES ISO 11926-3

| 代号 PART NO. | 螺纹 THREAD | | O形圈 O-RING | | 尺寸 DIMENSIONS | | | | |
|----------------|------------|------------|------------|------|---------------|------|----|----|--|
| | E | F | | F端 | A | B | S1 | S2 | |
| 1JO9-04OGL | 7/16"X20 | 7/16"X20 | | O904 | 24.5 | 44 | 11 | 17 | |
| 1JO9-06OGL | 9/16"X18 | 9/16"X18 | | O906 | 26.9 | 52.8 | 14 | 19 | |
| 1JO9-08OGL | 3/4"X16 | 3/4"X16 | | O908 | 32.5 | 63.5 | 19 | 24 | |
| 1JO9-10OGL | 7/8"X14 | 7/8"X14 | | O910 | 37.8 | 73.4 | 22 | 27 | |
| 1JO9-12OGL | 1.1/16"X12 | 1.1/16"X12 | | O912 | 44.2 | 84.8 | 27 | 32 | |
| 1JO9-16OGL | 1.5/16"X12 | 1.5/16"X12 | | O916 | 49 | 94.5 | 33 | 41 | |

注：1螺母及衬套需另行订货。管子直径D为公制时，配用螺母及衬套分别选用NB200、NB500。管子直径为英制时，配用螺母及衬套分别选用NB200、NB300。 2 F端与ISO 11926-1油口相配。 Note: 1 Nut and sleeve should be ordered separately. The nut NB200 and sleeve NB500 is suitable for metric tube, the nut NB200 and sleeve NB300 is suitable for inch tube. 2 F end is connected with ISO 11926-1 port.

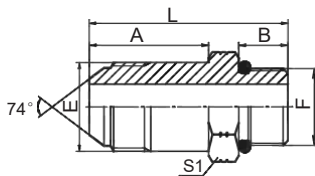

1JO-L

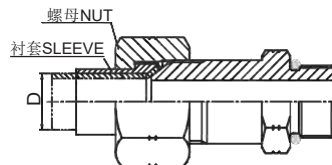

加长美制JIC外螺纹74° 外锥 /
SAE外螺纹带O形圈轻系列ISO 11926-3
LONG JIC MALE 74° CONE /
SAE O-RING BOSS L-SERIES ISO 11926-3

| 代号 PART NO. | 螺纹 THREAD | | O形圈 O-RING | | 尺寸 DIMENSIONS | | | | |
|----------------|------------|------------|------------|------|---------------|------|------|----|--|
| | E | F | | F端 | A | B | L | S1 | |
| 1JO-04L | 7/16"X20 | 7/16"X20 | | O904 | 35 | 9.1 | 50.5 | 14 | |
| 1JO-05L | 1/2"X20 | 1/2"X20 | | O905 | 37 | 9.1 | 52.5 | 17 | |
| 1JO-06L | 9/16"X18 | 9/16"X18 | | O906 | 39 | 9.9 | 55.5 | 17 | |
| 1JO-08L | 3/4"X16 | 3/4"X16 | | O908 | 48 | 11.1 | 67.5 | 22 | |
| 1JO-10L | 7/8"X14 | 7/8"X14 | | O910 | 53 | 12.7 | 76 | 27 | |
| 1JO-12L | 1.1/16"X12 | 1.1/16"X12 | | O912 | 63 | 15.1 | 89 | 32 | |
| 1JO-16L | 1.5/16"X12 | 1.5/16"X12 | | O916 | 72 | 15.1 | 100 | 38 | |
| 1JO-20L | 1.5/8"X12 | 1.5/8"X12 | | O920 | 88.1 | 15.1 | 118 | 50 | |

注：螺母及衬套需另行订货。管子直径D为公制时，配用螺母及衬套分别选用NB200、NB500。管子直径为英制时，配用螺母及衬套分别选用NB200、NB300。 Note: Nut and sleeve should be ordered separately. The nut NB200 and sleeve NB500 is suitable for metric tube, the nut NB200 and sleeve NB300 is suitable for inch tube.

H

美制螺纹JIC 74° 锥面扩口接头 JIC 74° Cone Flared Tube Fittings

1JS

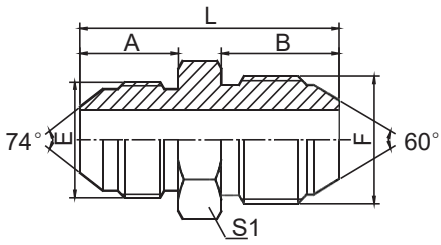

美制JIC外螺纹74° 外锥 / 日本英管外螺纹
JIC MALE 74° CONE / JIS GAS MALE

| 代号 PART NO. | 螺纹 THREAD | | 尺寸 DIMENSIONS | | | | | |
|----------------|-------------|------------|---------------|----|------|----|--|--|
| | E | F | A | B | L | S1 | | |
| 1JS-04 | 7/16"X20 | G1/4"X19 | 14 | 16 | 36 | 14 | | |
| 1JS-04-06 | 7/16"X20 | G3/8"X19 | 14 | 18 | 38 | 17 | | |
| 1JS-05-04 | 1/2"X20 | G1/4"X19 | 14 | 16 | 36 | 14 | | |
| 1JS-05-06 | 1/2"X20 | G3/8"X19 | 14 | 18 | 38 | 17 | | |
| 1JS-06 | 9/16"X18 | G3/8"X19 | 14.1 | 18 | 38 | 17 | | |
| 1JS-06-08 | 9/16"X18 | G1/2"X14 | 14.1 | 20 | 42 | 22 | | |
| 1JS-08-06 | 3/4"X16 | G3/8"X19 | 16.7 | 18 | 42.5 | 22 | | |
| 1JS-08 | 3/4"X16 | G1/2"X14 | 16.7 | 20 | 44.5 | 22 | | |
| 1JS-08-12 | 3/4"X16 | G3/4"X14 | 16.7 | 22 | 48.5 | 30 | | |
| 1JS-10-08 | 7/8"X14 | G1/2"X14 | 19.3 | 20 | 47.5 | 24 | | |
| 1JS-10-12 | 7/8"X14 | G3/4"X14 | 19.3 | 22 | 51.5 | 30 | | |
| 1JS-12 | 1.1/16 "X12 | G3/4"X14 | 21.9 | 22 | 54 | 30 | | |
| 1JS-12-16 | 1.1/16 "X12 | G1"X11 | 21.9 | 24 | 57 | 36 | | |
| 1JS-16-12 | 1.5/16"X12 | G3/4"X14 | 23.1 | 22 | 56 | 36 | | |
| 1JS-16 | 1.5/16"X12 | G1"X11 | 23.1 | 24 | 58 | 36 | | |
| 1JS-16-20 | 1.5/16"X12 | G1.1/4"X11 | 23.1 | 27 | 63 | 46 | | |
| 1JS-20 | 1.5/8"X12 | G1.1/4"X11 | 24.3 | 27 | 64.5 | 46 | | |
| 1JS-20-24 | 1.5/8"X12 | G1.1/2"X11 | 24.3 | 27 | 66 | 50 | | |

美制螺纹JIC 74° 锥面扩口接头 JIC 74° Cone Flared Tube Fittings

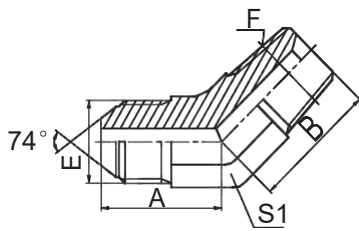

1JT4-SP

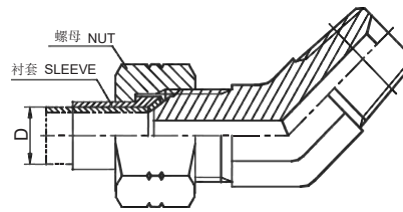

45° 弯美制JIC外螺纹74° 外锥 / 英锥管外螺纹
45° ELBOW JIC MALE 74° CONE / BSPT MALE

| 代号 PART NO. | 螺纹 THREAD | | 尺寸 DIMENSIONS | | | | | |
|----------------|------------|------------|---------------|------|----|--|--|--|
| | E | F | A | B | S1 | | | |
| 1JT4-04-02SP | 7/16"X20 | R1/8"X28 | 21.5 | 17 | 11 | | | |
| 1JT4-04SP | 7/16"X20 | R1/4"X19 | 22.3 | 21 | 14 | | | |
| 1JT4-04-06SP | 7/16"X20 | R3/8"X19 | 22.5 | 23 | 16 | | | |
| 1JT4-04-08SP | 7/16"X20 | R1/2"X14 | 24.5 | 29.5 | 22 | | | |
| 1JT4-05-02SP | 1/2"X20 | R1/8"X28 | 21.5 | 17.5 | 14 | | | |
| 1JT4-05-04SP | 1/2"X20 | R1/4"X19 | 22.3 | 21 | 14 | | | |
| 1JT4-05-06SP | 1/2"X20 | R3/8"X19 | 22.8 | 23 | 16 | | | |
| 1JT4-06-02SP | 9/16"X18 | R1/8"X28 | 22.8 | 18 | 14 | | | |
| 1JT4-06-04SP | 9/16"X18 | R1/4"X19 | 22.8 | 21 | 14 | | | |
| 1JT4-06SP | 9/16"X18 | R3/8"X19 | 22 | 23 | 16 | | | |
| 1JT4-06-08SP | 9/16"X18 | R1/2"X14 | 25 | 29.5 | 22 | | | |
| 1JT4-08-04SP | 3/4"X16 | R1/4"X19 | 26.8 | 22 | 19 | | | |
| 1JT4-08-06SP | 3/4"X16 | R3/8"X19 | 26.8 | 24 | 19 | | | |
| 1JT4-08SP | 3/4"X16 | R1/2"X14 | 28 | 29.5 | 22 | | | |
| 1JT4-08-12SP | 3/4"X16 | R3/4"X14 | 29 | 30.5 | 27 | | | |
| 1JT4-10-06SP | 7/8"X14 | R3/8"X19 | 31 | 25 | 22 | | | |
| 1JT4-10-08SP | 7/8"X14 | R1/2"X14 | 31 | 29.5 | 22 | | | |
| 1JT4-10-12SP | 7/8"X14 | R3/4"X14 | 32 | 30.5 | 27 | | | |
| 1JT4-12-08SP | 1.1/16"X12 | R1/2"X14 | 35.5 | 30 | 27 | | | |
| 1JT4-12SP | 1.1/16"X12 | R3/4"X14 | 35.5 | 30.5 | 27 | | | |
| 1JT4-12-16SP | 1.1/16"X12 | R1"X11 | 37.5 | 38 | 33 | | | |
| 1JT4-16-12SP | 1.5/16"X12 | R3/4"X14 | 38.5 | 32.5 | 33 | | | |
| 1JT4-16SP | 1.5/16"X12 | R1"X11 | 38.5 | 38 | 33 | | | |
| 1JT4-16-20SP | 1.5/16"X12 | R1.1/4"X11 | 42 | 43 | 41 | | | |
| 1JT4-20-16SP | 1.5/8"X12 | R1"X11 | 43 | 42 | 41 | | | |
| 1JT4-20SP | 1.5/8"X12 | R1.1/4"X11 | 43 | 43 | 41 | | | |
| 1JT4-20-24SP | 1.5/8"X12 | R1.1/2"X11 | 46 | 47.5 | 48 | | | |
| 1JT4-24-20SP | 1.7/8"X12 | R1.1/4"X11 | 49 | 45.5 | 48 | | | |
| 1JT4-24SP | 1.7/8"X12 | R1.1/2"X11 | 49 | 47.5 | 48 | | | |
| 1JT4-32SP | 2.1/2"X12 | R2"X11 | 58 | 50 | 63 | | | |

注：螺母及衬套需另行订货。管子直径D为公制时，配用螺母及衬套分别选用NB200、NB500。管子直径为英制时，配用螺母及衬套分别选用NB200、NB300。 Note: Nut and sleeve should be ordered separately. The nut NB200 and sleeve NB500 is suitable for metric tube, the nut NB200 and sleeve NB300 is suitable for inch tube.

H

美制螺纹JIC 74° 锥面扩口接头 JIC 74° Cone Flared Tube Fittings

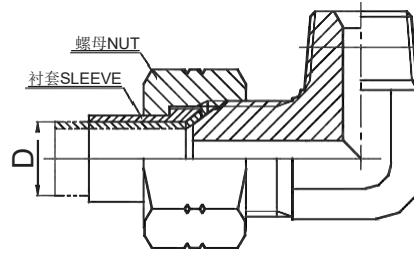
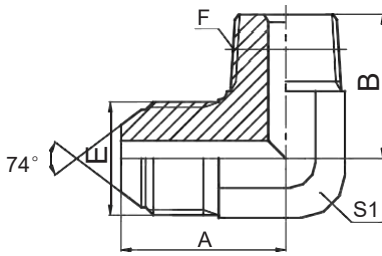

1JT9-SP

90° 弯美制JIC外螺纹74° 外锥 / 英锥管外螺纹
90° ELBOW JIC MALE 74° CONE / BSPT MALE

| 代号 PART NO. | 螺 纹 THREAD | | 尺 寸 DIMENSIONS | | | | | | |
|----------------|------------|------------|----------------|--|------|------|----|--|--|
| | E | F | | | A | B | S1 | | |
| 1JT9-02SP | 5/16"X24 | R1/8"X28 | | | 20.5 | 21 | 11 | | |
| 1JT9-04-02SP | 7/16"X20 | R1/8"X28 | | | 24.5 | 21 | 11 | | |
| 1JT9-04SP | 7/16"X20 | R1/4"X19 | | | 26.6 | 25.5 | 14 | | |
| 1JT9-04-06SP | 7/16"X20 | R3/8"X19 | | | 27.5 | 28 | 16 | | |
| 1JT9-05-02SP | 1/2"X20 | R1/8"X28 | | | 26.6 | 23.5 | 14 | | |
| 1JT9-05-04SP | 1/2"X20 | R1/4"X19 | | | 26.6 | 25.5 | 14 | | |
| 1JT9-05-06SP | 1/2"X20 | R3/8"X19 | | | 27.5 | 28 | 16 | | |
| 1JT9-06-02SP | 9/16"X18 | R1/8"X28 | | | 26.9 | 23.5 | 14 | | |
| 1JT9-06-04SP | 9/16"X18 | R1/4"X19 | | | 26.9 | 25.5 | 14 | | |
| 1JT9-06SP | 9/16"X18 | R3/8"X19 | | | 28.5 | 28.5 | 16 | | |
| 1JT9-06-08SP | 9/16"X18 | R1/2"X14 | | | 32 | 36 | 22 | | |
| 1JT9-08-04SP | 3/4"X16 | R1/4"X19 | | | 32 | 28 | 19 | | |
| 1JT9-08-06SP | 3/4"X16 | R3/8"X19 | | | 32 | 30.5 | 19 | | |
| 1JT9-08SP | 3/4"X16 | R1/2"X14 | | | 34.8 | 36 | 22 | | |
| 1JT9-08-12SP | 3/4"X16 | R3/4"X14 | | | 37.9 | 43.5 | 27 | | |
| 1JT9-10-06SP | 7/8"X14 | R3/8"X19 | | | 38 | 32 | 22 | | |
| 1JT9-10-08SP | 7/8"X14 | R1/2"X14 | | | 37.8 | 36 | 22 | | |
| 1JT9-10-12SP | 7/8"X14 | R3/4"X14 | | | 41 | 43.5 | 27 | | |
| 1JT9-12-08SP | 1.1/16"X12 | R1/2"X14 | | | 44.2 | 40 | 27 | | |
| 1JT9-12SP | 1.1/16"X12 | R3/4"X14 | | | 44.2 | 43.5 | 27 | | |
| 1JT9-12-16SP | 1.1/16"X12 | R1"X11 | | | 47.8 | 50 | 33 | | |
| 1JT9-16-12SP | 1.5/16"X12 | R3/4"X14 | | | 49 | 47.5 | 33 | | |
| 1JT9-16SP | 1.5/16"X12 | R1"X11 | | | 49 | 50 | 33 | | |
| 1JT9-16-20SP | 1.5/16"X12 | R1.1/4"X11 | | | 54 | 56.5 | 41 | | |
| 1JT9-20-16SP | 1.5/8"X12 | R1"X11 | | | 55.5 | 56.5 | 41 | | |
| 1JT9-20SP | 1.5/8"X12 | R1.1/4"X11 | | | 55.5 | 56.5 | 41 | | |
| 1JT9-24-20SP | 1.7/8"X12 | R1.1/4"X11 | | | 62.5 | 61 | 48 | | |
| 1JT9-24SP | 1.7/8"X12 | R1.1/2"X11 | | | 62.5 | 62.5 | 48 | | |
| 1JT9-24-32SP | 1.7/8"X12 | R2"X11 | | | 74.5 | 67 | 63 | | |
| 1JT9-32SP | 2.1/2"X12 | R2"X11 | | | 75.4 | 67 | 63 | | |

注：螺母及衬套需另行订货。管子直径D为公制时， 配用螺母及衬套分别选用NB200、NB500。管子直径为英制时， 配用螺母及衬套分别选用NB200、NB300。 Note: Nut and sleeve should be ordered separately. The nut NB200 and sleeve NB500 is suitable for metric tube, the nut NB200 and sleeve NB300 is suitable for inch tube.

美制螺纹JIC 74° 锥面扩口接头 JIC 74° Cone Flared Tube Fittings

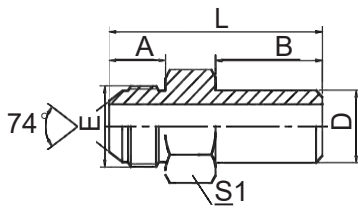

1JW

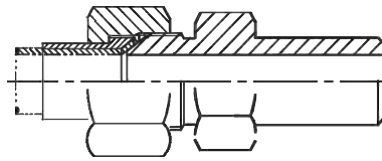

美制JIC外螺纹74° 外锥 / 焊接管
JIC MALE 74° CONE / BUTT-WELD TUBE

| 代号 PART NO. | 螺纹 THREAD | | 尺寸 DIMENSIONS | | | | |
|----------------|------------|--|---------------|----|----|------|----|
| | E | | A | B | D | L | S1 |
| 1JW-06-14 | 9/16"X18 | | 14.1 | 8 | 14 | 28 | 17 |
| 1JW-08-18 | 3/4"X16 | | 16.7 | 10 | 18 | 35 | 22 |
| 1JW-12-22 | 1.1/16"X12 | | 21.9 | 10 | 22 | 42 | 30 |
| 1JW-12-28 | 1.1/16"X12 | | 21.9 | 12 | 28 | 44 | 30 |
| 1JW-16-28 | 1.5/16"X12 | | 23 | 12 | 28 | 46 | 36 |
| 1JW-20-34 | 1.5/8"X12 | | 24.3 | 14 | 34 | 51.5 | 46 |
| 1JW-32-60 | 2.1/2"X12 | | 33.9 | 20 | 60 | 71 | 65 |

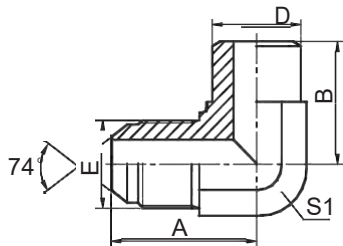

1JW9-IN

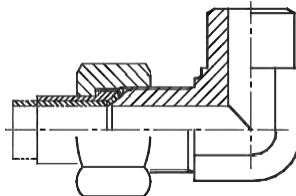

90° JIC外螺纹74° 外锥 / 英寸制焊接管
90° JIC MALE 74° CONE / INCH WELD TUBE

| 代号 PART NO. | 螺纹 THREAD | | 焊接管外径 D | 尺寸 DIMENSIONS | | |
|----------------|------------|--|-----------------|---------------|------|----|
| | E | | WELD TUBE O.D D | A | B | S1 |
| 1JW9-04IN | 7/16"X20 | | 1/4" | 24.5 | 22.5 | 11 |
| 1JW9-06IN | 9/16"X18 | | 3/8" | 26.9 | 22.5 | 14 |
| 1JW9-08IN | 3/4"X16 | | 1/2" | 32 | 25 | 19 |
| 1JW9-10IN | 7/8"X14 | | 5/8" | 37.8 | 31 | 22 |
| 1JW9-12IN | 1.1/16"X12 | | 3/4" | 44.2 | 34.5 | 27 |
| 1JW9-16IN | 1.5/16"X12 | | 1" | 48.8 | 41 | 33 |
| 1JW9-20IN | 1.5/8"X12 | | 1.1/4" | 55.3 | 43 | 41 |
| 1JW9-24IN | 1.7/8"X12 | | 1.1/2" | 62.5 | 53 | 48 |

H

美制螺纹JIC 74° 锥面扩口接头 JIC 74° Cone Flared Tube Fittings

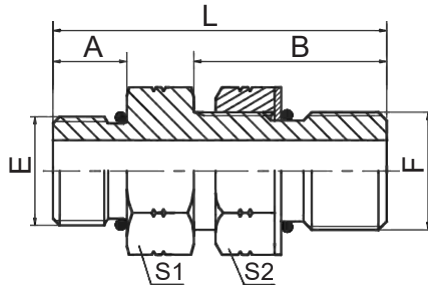

10-OG

美制SAE外螺纹带O形圈堵头轻系列ISO 11926-3
SAE O-RING BOSS PLUG L-SERIES ISO 11926-3

| 代号 PART NO. | 螺 纹 THREAD | | O形圈 O-RING | | 尺 寸 DIMENSIONS | | | | |
|----------------|------------|------------|------------|------|----------------|----|------|----|----|
| | E | F | E端 | F端 | A | B | L | S1 | S2 |
| 10-04OG | 7/16"X20 | 7/16"X20 | O904 | O904 | 9.14 | 18 | 33 | 14 | 17 |
| 10-04-06OG | 7/16"X20 | 9/16"X18 | O904 | O906 | 9.14 | 20 | 35.1 | 17 | 19 |
| 10-06OG | 9/16"X18 | 9/16"X18 | O906 | O906 | 9.93 | 20 | 36 | 17 | 19 |
| 10-06-08OG | 9/16"X18 | 3/4"X16 | O906 | O908 | 9.93 | 22 | 40 | 22 | 24 |
| 10-08OG | 3/4"X16 | 3/4"X16 | O908 | O908 | 11.13 | 22 | 40 | 22 | 24 |
| 10-08-12OG | 3/4"X16 | 1.1/16"X12 | O908 | O912 | 11.13 | 29 | 51 | 32 | 32 |
| 10-10OG | 7/8"X14 | 7/8"X14 | O910 | O910 | 12.7 | 26 | 46 | 27 | 27 |
| 10-12OG | 1.1/16"X12 | 1.1/16"X12 | O912 | O912 | 15.1 | 29 | 54 | 32 | 32 |
| 10-16OG | 1.5/16"X12 | 1.5/16"X12 | O916 | O916 | 15.1 | 29 | 54 | 38 | 41 |
| 10-20OG | 1.5/8"X12 | 1.5/8"X12 | O920 | O920 | 15.1 | 29 | 54 | 50 | 50 |
| 10-24OG | 1.7/8"X12 | 1.7/8"X12 | O924 | O924 | 15.1 | 29 | 54 | 55 | 55 |

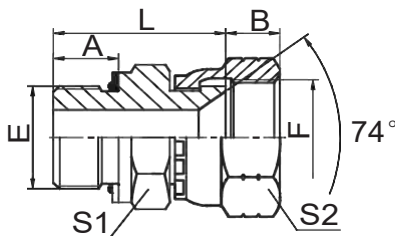

2GJ

英管外螺纹O形圈 / JIC内螺纹74° 内锥面
BSP MALE O-RING / JIC FEMALE 74° SEAT

| 代号 PART NO. | 螺 纹 THREAD | | O 形圈 O-RING | | 尺 寸 DIMENSIONS | | | | |
|----------------|------------|------------|-------------|--|----------------|------|------|-----|-----|
| | E | F | E 端 | | A | B | L | S 1 | S 2 |
| 2GJ-04 | G1/4"X19 | 7/16"X20 | 10.77X2.62 | | 10 | 9 | 26.5 | 19 | 15 |
| 2GJ-04-05 | G1/4"X19 | 1/2"X20 | 10.77X2.62 | | 11 | 9 | 27 | 19 | 17 |
| 2GJ-04-06 | G1/4"X19 | 9/16"X18 | 10.77X2.62 | | 11 | 10.5 | 27 | 19 | 19 |
| 2GJ-06 | G3/8"X19 | 9/16"X18 | 13.94X2.62 | | 11.5 | 10.5 | 29.5 | 24 | 19 |
| 2GJ-06-08 | G3/8"X19 | 3/4"X16 | 13.94X2.62 | | 11.5 | 10.5 | 31.5 | 24 | 24 |
| 2GJ-08 | G1/2"X14 | 3/4"X16 | 17.12X2.62 | | 14 | 10.5 | 36 | 27 | 24 |
| 2GJ-08-06 | G1/2"X14 | 9/16"X18 | 17.12X2.62 | | 14 | 10.5 | 35.5 | 27 | 19 |
| 2GJ-08-10 | G1/2"X14 | 7/8"X14 | 17.12X2.62 | | 14 | 12 | 36.5 | 27 | 27 |
| 2GJ-12 | G3/4"X14 | 1.1/16"X12 | 23.47X2.62 | | 15.5 | 15 | 39 | 36 | 32 |
| 2GJ-12-08 | G3/4"X14 | 3/4"X16 | 23.47X2.62 | | 15.5 | 10.5 | 38 | 36 | 24 |
| 2GJ-12-10 | G3/4"X14 | 7/8"X14 | 23.47X2.62 | | 15.5 | 11 | 40.5 | 36 | 27 |
| 2GJ-12-16 | G3/4"X14 | 1.5/16"X12 | 23.47X2.62 | | 15.5 | 16 | 39 | 36 | 41 |
| 2GJ-16 | G1"X11 | 1.5/16"X12 | 29.74X3.53 | | 18 | 16 | 45 | 41 | 41 |
| 2GJ-20 | G1.1/4"X11 | 1.5/8"X12 | 37.69X3.53 | | 20 | 17 | 53 | 50 | 50 |
| 2GJ-24 | G1.1/2"X11 | 1.7/8"X12 | 44.04X3.53 | | 21.5 | 20 | 57 | 60 | 55 |

美制螺纹JIC 74° 锥面扩口接头 JIC 74° Cone Flared Tube Fittings

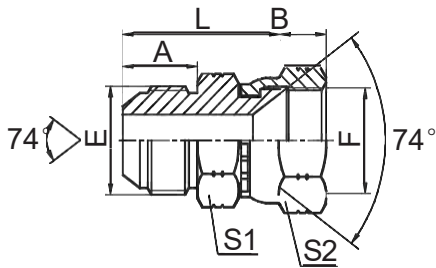

2J

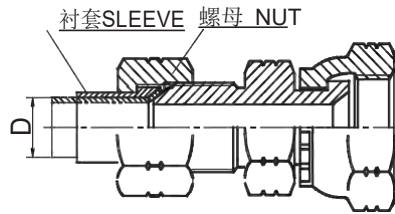

美制JIC外螺纹74° 外锥 / JIC内螺纹74° 内锥
JIC MALE 74° CONE / JIC FEMALE 74° SEAT

| 代号 PART NO. | 螺纹 THREAD | | 尺寸 DIMENSIONS | | | | |
|----------------|------------|------------|---------------|------|------|----|----|
| | E | F | A | B | L | S1 | S2 |
| 2J-04 | 7/16"X20 | 7/16"X20 | 14 | 9 | 28 | 12 | 15 |
| 2J-04-05 | 7/16"X20 | 1/2"X20 | 14 | 9.5 | 28.5 | 12 | 17 |
| 2J-04-06 | 7/16"X20 | 9/16"X18 | 14 | 10.5 | 28.5 | 14 | 19 |
| 2J-04-08 | 7/16"X20 | 3/4"X16 | 14 | 11 | 30.5 | 19 | 24 |
| 2J-05 | 1/2"X20 | 1/2"X20 | 14 | 9.5 | 29 | 14 | 17 |
| 2J-05-06 | 1/2"X20 | 9/16"X18 | 14 | 10.5 | 28.5 | 14 | 19 |
| 2J-05-08 | 1/2"X20 | 3/4"X16 | 14 | 11 | 30.5 | 19 | 24 |
| 2J-06 | 9/16"X18 | 9/16"X18 | 14.1 | 10.5 | 29 | 17 | 19 |
| 2J-06-08 | 9/16"X18 | 3/4"X16 | 14.1 | 11 | 31 | 19 | 24 |
| 2J-06-10 | 9/16"X18 | 7/8"X14 | 14.1 | 13 | 33.5 | 22 | 27 |
| 2J-08 | 3/4"X16 | 3/4"X16 | 16.7 | 11 | 36 | 22 | 24 |
| 2J-08-06 | 3/4"X16 | 9/16"X18 | 16.7 | 10.5 | 34 | 22 | 19 |
| 2J-08-10 | 3/4"X16 | 7/8"X14 | 16.7 | 13 | 36.5 | 22 | 27 |
| 2J-08-12 | 3/4"X16 | 1.1/16"X12 | 16.7 | 15 | 39.5 | 27 | 32 |
| 2J-10 | 7/8"X14 | 7/8"X14 | 19.3 | 13 | 39 | 24 | 27 |
| 2J-10-08 | 7/8"X14 | 3/4"X16 | 19.3 | 11 | 38 | 24 | 24 |
| 2J-10-12 | 7/8"X14 | 1.1/16"X12 | 19.3 | 15 | 42 | 27 | 32 |
| 2J-12 | 1.1/16"X12 | 1.1/16"X12 | 21.9 | 15 | 44.5 | 30 | 32 |
| 2J-12-10 | 1.1/16"X12 | 7/8"X14 | 21.9 | 13 | 43.5 | 30 | 27 |
| 2J-12-16 | 1.1/16"X12 | 1.5/16"X12 | 21.9 | 16 | 45.5 | 36 | 41 |
| 2J-16 | 1.5/16"X12 | 1.5/16"X12 | 23.1 | 16 | 46.5 | 36 | 41 |
| 2J-16-20 | 1.5/16"X12 | 1.5/8"X12 | 23.1 | 17 | 53 | 41 | 50 |
| 2J-20 | 1.5/8"X12 | 1.5/8"X12 | 24.3 | 17 | 54 | 46 | 50 |
| 2J-20-24 | 1.5/8"X12 | 1.7/8"X12 | 24.3 | 20 | 55.5 | 46 | 55 |
| 2J-24 | 1.7/8"X12 | 1.7/8"X12 | 27.5 | 20 | 61 | 50 | 55 |
| 2J-24-32 | 1.7/8"X12 | 2.1/2"X12 | 27.5 | 24.5 | 62 | 65 | 75 |
| 2J-32 | 2.1/2"X12 | 2.1/2"X12 | 33.9 | 24.5 | 69.5 | 65 | 75 |

注：螺母及衬套需另行订货。管子直径D为公制时，配用螺母及衬套分别选用NB200、NB500。管子直径为英制时，配用螺母及衬套分别选用NB200、NB300。 Note: Nut and sleeve should be ordered separately. The nut NB200 and sleeve NB500 is suitable for metric tube, the nut NB200 and sleeve NB300 is suitable for inch tube.

H

美制螺纹JIC 74° 锥面扩口接头 JIC 74° Cone Flared Tube Fittings

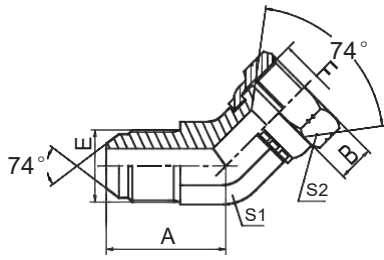

2J4

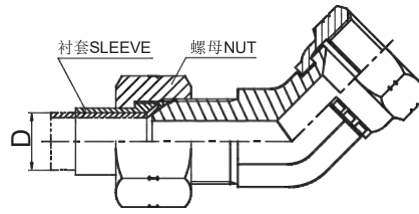

45° 弯美制JIC外螺纹74° 外锥 / JIC内螺纹74° 内锥
45° ELBOW JIC MALE 74° CONE / JIC FEMALE 74° SEAT

| 代号 PART NO. | 螺 纹 THREAD | | 尺 寸 DIMENSIONS | | | | |
|----------------|------------|------------|----------------|------|----|----|--|
| | E | F | A | B | S1 | S2 | |
| 2J4-04 | 7/16"X20 | 7/16"X20 | 21.5 | 9 | 11 | 15 | |
| 2J4-05 | 1/2"X20 | 1/2"X20 | 22 | 9.5 | 14 | 17 | |
| 2J4-06 | 9/16"X18 | 9/16"X18 | 22.8 | 10.5 | 14 | 19 | |
| 2J4-08 | 3/4"X16 | 3/4"X16 | 26.8 | 11 | 19 | 24 | |
| 2J4-10 | 7/8"X14 | 7/8"X14 | 31 | 13 | 22 | 27 | |
| 2J4-12 | 1.1/16"X12 | 1.1/16"X12 | 35.5 | 15 | 27 | 32 | |
| 2J4-14 | 1.3/16"X12 | 1.3/16"X12 | 37 | 15 | 30 | 36 | |
| 2J4-16 | 1.5/16"X12 | 1.5/16"X12 | 38.5 | 16 | 33 | 41 | |
| 2J4-20 | 1.5/8"X12 | 1.5/8"X12 | 43 | 17 | 41 | 50 | |
| 2J4-24 | 1.7/8"X12 | 1.7/8"X12 | 49 | 20 | 48 | 55 | |
| 2J4-32 | 2.1/2"X12 | 2.1/2"X12 | 58 | 24.5 | 63 | 75 | |

注：螺母及衬套需另行订货。管子直径D为公制时，配用螺母及衬套分别选用NB200、NB500。管子直径为英制时，配用螺母及衬套分别选用NB200、NB300。 Note: Nut and sleeve should be ordered separately. The nut NB200 and sleeve NB500 is suitable for metric tube, the nut NB200 and sleeve NB300 is suitable for inch tube.

美制螺纹JIC 74° 锥面扩口接头 JIC 74° Cone Flared Tube Fittings

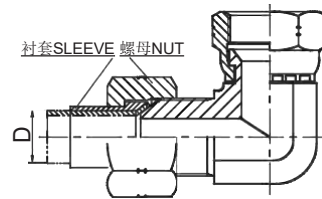
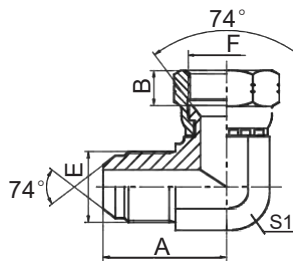

2J9

90°弯美制JIC外螺纹74°外锥 / JIC内螺纹74°内锥
90° ELBOW JIC MALE 74° CONE / JIC FEMALE 74° SEAT

| 代号 PART NO. | 螺 纹 THREAD | | 尺 寸 DIMENSIONS | | | | | | |
|----------------|------------|------------|----------------|------|----|----|--|--|--|
| | E | F | A | B | S1 | S2 | | | |
| 2J9-02 | 5/16"X24 | 5/16"X24 | 21 | 5.6 | 11 | 12 | | | |
| 2J9-03 | 3/8"X24 | 3/8"X24 | 22 | 5 | 11 | 14 | | | |
| 2J9-04 | 7/16"X20 | 7/16"X20 | 24.5 | 9 | 11 | 15 | | | |
| 2J9-05 | 1/2"X20 | 1/2"X20 | 26.5 | 9.5 | 14 | 17 | | | |
| 2J9-06 | 9/16"X18 | 9/16"X18 | 26.9 | 10.5 | 14 | 19 | | | |
| 2J9-06-08 | 9/16"X18 | 3/4"X16 | 28.5 | 11 | 16 | 24 | | | |
| 2J9-08-06 | 3/4"X16 | 9/16"X18 | 32 | 10.5 | 19 | 19 | | | |
| 2J9-08 | 3/4"X16 | 3/4"X16 | 32 | 11 | 19 | 24 | | | |
| 2J9-08-10 | 3/4"X16 | 7/8"X14 | 32 | 13 | 19 | 27 | | | |
| 2J9-10 | 7/8"X14 | 7/8"X14 | 37.8 | 13 | 22 | 27 | | | |
| 2J9-10-08 | 7/8"X14 | 3/4"X16 | 37.8 | 11 | 22 | 24 | | | |
| 2J9-10-12 | 7/8"X14 | 1.1/16"X12 | 39.5 | 15 | 24 | 32 | | | |
| 2J9-12 | 1.1/16"X12 | 1.1/16"X12 | 44.2 | 15 | 27 | 32 | | | |
| 2J9-12-10 | 1.1/16"X12 | 7/8"X14 | 44.2 | 13 | 27 | 27 | | | |
| 2J9-12-16 | 1.1/16"X12 | 1.5/16"X12 | 46 | 16 | 30 | 41 | | | |
| 2J9-14 | 1.3/16"X12 | 1.3/16"X12 | 47.5 | 15 | 30 | 36 | | | |
| 2J9-16 | 1.5/16"X12 | 1.5/16"X12 | 48.8 | 16 | 33 | 41 | | | |
| 2J9-16-20 | 1.5/16"X12 | 1.5/8"X12 | 54 | 17 | 41 | 50 | | | |
| 2J9-20-16 | 1.5/8"X12 | 1.5/16"X12 | 55.5 | 16 | 41 | 41 | | | |
| 2J9-20 | 1.5/8"X12 | 1.5/8"X12 | 55.5 | 17 | 41 | 50 | | | |
| 2J9-20-24 | 1.5/8"X12 | 1.7/8"X12 | 59.5 | 20 | 48 | 55 | | | |
| 2J9-24-20 | 1.7/8"X12 | 1.5/8"X12 | 62.5 | 17 | 48 | 50 | | | |
| 2J9-24 | 1.7/8"X12 | 1.7/8"X12 | 62.5 | 20 | 48 | 55 | | | |
| 2J9-32 | 2.1/2"X12 | 2.1/2"X12 | 75.5 | 24.5 | 63 | 75 | | | |

注：螺母及衬套需另行订货。管子直径D为公制时，配用螺母及衬套分别选用NB200、NB500。管子直径为英制时，配用螺母及衬套分别选用NB200、NB300。 Note: Nut and sleeve should be ordered separately. The nut NB200 and sleeve NB500 is suitable for metric tube, the nut NB200 and sleeve NB300 is suitable for inch tube.

H

美制螺纹JIC 74° 锥面扩口接头 JIC 74° Cone Flared Tube Fittings

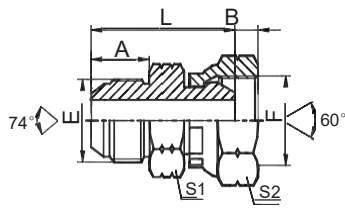

2JB

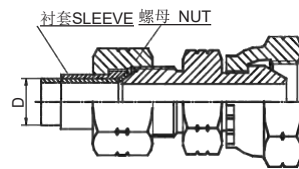

JIC外螺纹74° 外锥 / 英管内螺纹60° 外锥
JIC MALE 74° CONE / BSP FEMALE 60° CONE

| 代号 PART NO. | 螺纹 THREAD | | 尺寸 DIMENSIONS | | | | |
|----------------|------------|------------|---------------|------|------|----|----|
| | E | F | A | B | L | S1 | S2 |
| 2JB-04 | 7/16"X20 | G1/4"X19 | 14 | 5.5 | 31 | 12 | 19 |
| 2JB-04-02 | 7/16"X20 | G1/8"X28 | 14 | 5.5 | 29 | 14 | 14 |
| 2JB-04-06 | 7/16"X20 | G3/8"X19 | 14 | 6.3 | 32.5 | 17 | 22 |
| 2JB-05-02 | 1/2"X20 | G1/8"X28 | 14 | 5.5 | 29 | 14 | 14 |
| 2JB-05-04 | 1/2"X20 | G1/4"X19 | 14 | 5.5 | 31 | 14 | 19 |
| 2JB-06 | 9/16"X18 | G3/8"X19 | 14.1 | 6.3 | 32.5 | 17 | 22 |
| 2JB-06-04 | 9/16"X18 | G1/4"X19 | 14.1 | 5.5 | 31 | 17 | 19 |
| 2JB-06-08 | 9/16"X18 | G1/2"X14 | 14.1 | 7.5 | 34 | 19 | 27 |
| 2JB-08 | 3/4"X16 | G1/2"X14 | 16.7 | 7.5 | 38.5 | 22 | 27 |
| 2JB-08-04 | 3/4"X16 | G1/4"X19 | 16.7 | 5.5 | 35.5 | 22 | 19 |
| 2JB-08-06 | 3/4"X16 | G3/8"X19 | 16.7 | 6.3 | 37 | 22 | 22 |
| 2JB-08-12 | 3/4"X16 | G3/4"X14 | 16.7 | 10.9 | 42 | 27 | 32 |
| 2JB-10 | 7/8"X14 | G5/8"X14 | 19.3 | 9.5 | 42 | 24 | 30 |
| 2JB-10-08 | 7/8"X14 | G1/2"X14 | 19.3 | 7.5 | 41 | 24 | 27 |
| 2JB-12 | 1.1/16"X12 | G3/4"X14 | 21.9 | 10.9 | 47 | 30 | 32 |
| 2JB-12-08 | 1.1/16"X12 | G1/2"X14 | 21.9 | 7.5 | 46 | 30 | 27 |
| 2JB-12-16 | 1.1/16"X12 | G1"X11 | 21.9 | 11.7 | 49.5 | 32 | 41 |
| 2JB-16 | 1.5/16"X12 | G1"X11 | 23.1 | 11.7 | 51 | 36 | 41 |
| 2JB-20 | 1.5/8"X12 | G1.1/4"X11 | 24.3 | 11 | 57 | 46 | 50 |
| 2JB-20-16 | 1.5/8"X12 | G1"X11 | 24.3 | 11.7 | 53.5 | 46 | 41 |
| 2JB-24 | 1.7/8"X12 | G1.1/2"X11 | 27.5 | 13 | 62.5 | 50 | 55 |
| 2JB-24-20 | 1.7/8"X12 | G1.1/4"X11 | 27.5 | 11 | 62.5 | 50 | 50 |

注：螺母及衬套需另行订货。管子直径D为公制时，配用螺母及衬套分别选用NB200、NB500。管子直径为英制时，配用螺母及衬套分别选用NB200、NB300。Nut and sleeve should be ordered separate ly.The nut NB200 and sleeve NB500 is suitable for metric tube,the nut NB200 and sleeve NB300 is suitable for inch tube.

美制螺纹JIC 74° 锥面扩口接头 JIC 74° Cone Flared Tube Fittings

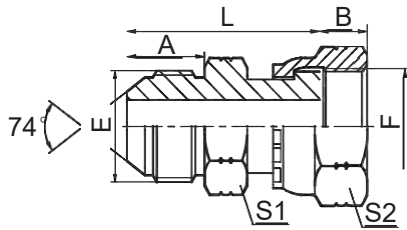

2JF

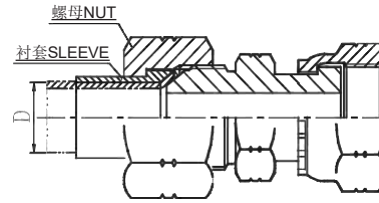

JIC外螺纹74° 内锥 / ORFS内螺纹 JIC MALE 74° CONE / ORFS FEMALE

| 代号 PART NO. | 螺 纹 THREAD | | 尺 寸 DIMENSIONS | | | | | |
|----------------|------------|-------------|----------------|------|------|----|----|--|
| | E | F | A | B | L | S1 | S2 | |
| 2JF-04 | 7/16"X20 | 9/16X18 | 14 | 8.5 | 35.5 | 14 | 19 | |
| 2JF-06 | 9/16"X18 | 11/16"X16 | 14.1 | 10 | 38.5 | 17 | 22 | |
| 2JF-08 | 3/4"X16 | 13/16"X16 | 16.7 | 11 | 45 | 22 | 27 | |
| 2JF-10 | 7/8"X14 | 1"X14 | 19.3 | 13.5 | 51.5 | 24 | 30 | |
| 2JF-12 | 1.1/16"X12 | 1.3/16"X12 | 21.9 | 15 | 58 | 30 | 36 | |
| 2JF-16 | 1.5/16"X12 | 1.7/16"X12 | 23.1 | 15 | 62 | 36 | 41 | |
| 2JF-20 | 1.5/8"X12 | 1.11/16"X12 | 24.3 | 15 | 68.5 | 46 | 50 | |

注：螺母及衬套需另行订货。管子直径D为公制时，配用螺母及衬套分别选用NB200、NB500。管子直径为英制时，配用螺母及衬套分别选用NB200、NB300。 Nut and sleeve should be ordered separately. The nut NB200 and sleeve NB500 is suitable for metric tube, the nut NB200 and sleeve NB300 is suitable for inch tube.

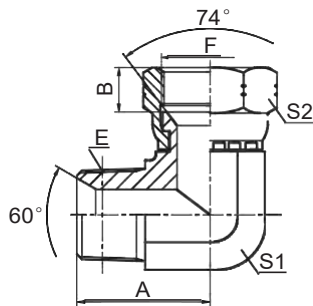

2NJ9

90° 美制布锥管外螺纹 / JIC内螺纹74° 内锥 90° NPT MALE / JIC FEMALE 74° SEAT

| 代号 PART NO. | 螺 纹 THREAD | | 尺 寸 DIMENSIONS | | | | | |
|----------------|--------------|------------|----------------|------|----|----|--|--|
| | E | F | A | B | S1 | S2 | | |
| 2NJ9-02-04 | Z1/4"X18 | 7/16"X20 | 21 | 9 | 11 | 17 | | |
| 2NJ9-02-05 | Z1/4"X18 | 1/2"X20 | 21 | 9 | 11 | 17 | | |
| 2NJ9-04 | Z1/4"X18 | 7/16"X20 | 25.5 | 9 | 14 | 17 | | |
| 2NJ9-04-06 | Z1/4"X18 | 9/16"X18 | 25.5 | 10.5 | 14 | 19 | | |
| 2NJ9-06 | Z3/8"X18 | 9/16"X18 | 31 | 10.5 | 19 | 19 | | |
| 2NJ9-06-08 | Z3/8"X18 | 3/4"X16 | 31 | 10.5 | 19 | 24 | | |
| 2NJ9-08 | Z1/2"X14 | 3/4"X16 | 37.3 | 10.5 | 22 | 24 | | |
| 2NJ9-08-10 | Z1/2"X14 | 7/8"X14 | 37.3 | 12 | 22 | 27 | | |
| 2NJ9-08-12 | Z1/2"X14 | 1.1/16"X12 | 37.5 | 15 | 24 | 32 | | |
| 2NJ9-12 | Z3/4"X14 | 1.1/16"X12 | 44 | 15 | 27 | 32 | | |
| 2NJ9-12-08 | Z3/4"X14 | 3/4"X16 | 43.5 | 10.5 | 27 | 24 | | |
| 2NJ9-12-10 | Z3/4"X14 | 7/8"X14 | 43.5 | 12 | 27 | 27 | | |
| 2NJ9-16 | Z1"X11.5 | 1.5/16"X12 | 50 | 16 | 33 | 41 | | |
| 2NJ9-16-14 | Z1"X11.5 | 1.3/16"X12 | 49 | 15 | 33 | 36 | | |
| 2NJ9-20 | Z1.1/4"X11.5 | 1.5/8"X12 | 53 | 17 | 41 | 50 | | |
| 2NJ9-24 | Z1.1/2"X11.5 | 1.7/8"X12 | 59 | 20 | 48 | 55 | | |

美制螺纹JIC 74° 锥面扩口接头 JIC 74° Cone Flared Tube Fittings

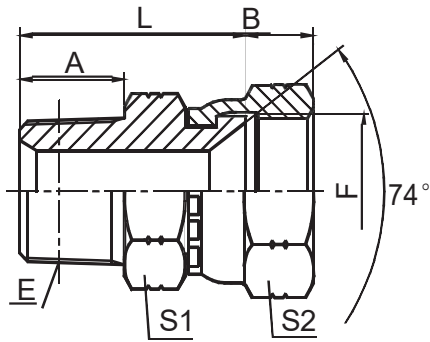

2NJ

布锥管外螺纹 / JIC内螺纹74° 内锥
NPT MALE / JIC FEMALE 74° SEAT

| 代号 PART NO. | 螺纹 THREAD | | 尺寸 DIMENSIONS | | | | | |
|----------------|--------------|------------|---------------|------|------|----|----|--|
| | E | F | A | B | L | S1 | S2 | |
| 2NJ-02-04 | Z1/8"X27 | 7/16"X20 | 10.5 | 9 | 24.5 | 12 | 17 | |
| 2NJ-02-05 | Z1/8"X27 | 1/2"X20 | 10.5 | 9 | 25 | 12 | 17 | |
| 2NJ-04 | Z1/4"X18 | 7/16"X20 | 15 | 9 | 29 | 17 | 17 | |
| 2NJ-04-05 | Z1/4"X18 | 1/2"X20 | 15 | 9 | 29.5 | 17 | 17 | |
| 2NJ-04-06 | Z1/4"X18 | 9/16"X18 | 15 | 10.5 | 29.5 | 17 | 19 | |
| 2NJ-04-08 | Z1/4"X18 | 3/4"X16 | 15 | 10.5 | 31.5 | 19 | 24 | |
| 2NJ-06 | Z3/8"X18 | 9/16"X18 | 16 | 10.5 | 30.5 | 19 | 19 | |
| 2NJ-06-08 | Z3/8"X18 | 3/4"X16 | 16 | 10.5 | 32.5 | 19 | 24 | |
| 2NJ-06-10 | Z3/8"X18 | 7/8"X14 | 16 | 12 | 35 | 22 | 27 | |
| 2NJ-08 | Z1/2"X14 | 3/4"X16 | 19.5 | 10.5 | 37.5 | 22 | 24 | |
| 2NJ-08-06 | Z1/2"X14 | 9/16"X18 | 19.5 | 10.5 | 36 | 22 | 19 | |
| 2NJ-08-10 | Z1/2"X14 | 7/8"X14 | 19.5 | 12 | 38 | 22 | 27 | |
| 2NJ-08-12 | Z1/2"X14 | 1.1/16"X12 | 19.5 | 15 | 42 | 27 | 32 | |
| 2NJ-12 | Z3/4"X14 | 1.1/16"X12 | 19.5 | 15 | 42 | 30 | 32 | |
| 2NJ-12-08 | Z3/4"X14 | 3/4"X16 | 19.5 | 10.5 | 40 | 30 | 24 | |
| 2NJ-12-10 | Z3/4"X14 | 7/8"X14 | 19.5 | 12 | 40.5 | 30 | 27 | |
| 2NJ-12-16 | Z3/4"X14 | 1.5/16"X12 | 19.5 | 16 | 42.5 | 32 | 41 | |
| 2NJ-16 | Z1"X11.5 | 1.5/16"X12 | 25.5 | 16 | 48 | 36 | 41 | |
| 2NJ-16-12 | Z1"X11.5 | 1.1/16"X12 | 25.5 | 15 | 49 | 36 | 32 | |
| 2NJ-16-20 | Z1"X11.5 | 1.5/8"X12 | 25.5 | 17 | 55 | 41 | 50 | |
| 2NJ-20 | Z1.1/4"X11.5 | 1.5/8"X12 | 26.5 | 17 | 56 | 46 | 50 | |
| 2NJ-20-24 | Z1.1/4"X11.5 | 1.7/8"X12 | 26.5 | 20 | 58 | 46 | 60 | |
| 2NJ-24-20 | Z1.1/2"X11.5 | 1.5/8"X12 | 27.5 | 17 | 59 | 50 | 50 | |
| 2NJ-24 | Z1.1/2"X11.5 | 1.7/8"X12 | 27.5 | 23.5 | 60.5 | 50 | 60 | |

美制螺纹JIC 74° 锥面扩口接头 JIC 74° Cone Flared Tube Fittings

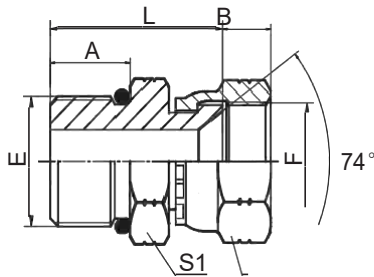

20J

SAE外螺纹带O形圈 / JIC内螺纹74° 内锥
SAE O-RING BOSS / JIC FEMALE 74° SEAT

| 代号 PART NO. | 螺纹 THREAD | | O形圈 O-RING | | 尺寸 DIMENSIONS | | | | |
|----------------|------------|------------|------------|--|---------------|------|------|----|----|
| | E | F | E端 | | A | B | L | S1 | S2 |
| 20J-04 | 7/16"X20 | 7/16"X20 | 8.92x1.83 | | 9.1 | 9 | 23 | 14 | 15 |
| 20J-05 | 1/2"X20 | 1/2"X20 | 10.52x1.83 | | 9.1 | 9 | 23.5 | 17 | 17 |
| 20J-05-04 | 1/2"X20 | 7/16"X20 | 10.52x1.83 | | 9.1 | 9 | 23 | 17 | 15 |
| 20J-06 | 9/16"X18 | 9/16"X18 | 11.89x1.98 | | 9.9 | 10.5 | 24.5 | 17 | 19 |
| 20J-06-04 | 9/16"X18 | 7/16"X20 | 11.89x1.98 | | 9.9 | 9 | 24 | 17 | 15 |
| 20J-06-08 | 9/16"X18 | 3/4"X16 | 11.89x1.98 | | 9.9 | 10.5 | 26 | 19 | 24 |
| 20J-08 | 3/4"X16 | 3/4"X16 | 16.36x2.21 | | 11.1 | 10.5 | 29.5 | 22 | 24 |
| 20J-08-06 | 3/4"X16 | 9/16"X18 | 16.36x2.21 | | 11.1 | 10.5 | 27.5 | 22 | 19 |
| 20J-08-10 | 3/4"X16 | 7/8"X14 | 19.18x2.46 | | 11.1 | 12 | 30 | 22 | 27 |
| 20J-10 | 7/8"X14 | 7/8"X14 | 19.18x2.46 | | 12.7 | 12 | 34 | 27 | 27 |
| 20J-10-08 | 7/8"X14 | 3/4"X16 | 19.18x2.46 | | 12.7 | 10.5 | 33 | 27 | 24 |
| 20J-10-12 | 7/8"X14 | 1.1/16"X12 | 23.47x2.95 | | 12.7 | 15 | 35 | 27 | 32 |
| 20J-12 | 1.1/16"X12 | 1.1/16"X12 | 23.47x2.95 | | 15.1 | 15 | 38.5 | 32 | 32 |
| 20J-12-08 | 1.1/16"X12 | 3/4"X16 | 23.47x2.95 | | 15.1 | 10.5 | 36.5 | 32 | 24 |
| 20J-12-10 | 1.1/16"X12 | 7/8"X14 | 23.47x2.95 | | 15.1 | 12 | 37 | 32 | 27 |
| 20J-12-16 | 1.1/16"X12 | 1.5/16"X12 | 23.47x2.95 | | 15.1 | 16 | 38.5 | 32 | 41 |
| 20J-14 | 1.3/16"X12 | 1.3/16"X12 | 26.62x2.95 | | 15.1 | 15 | 38.5 | 36 | 36 |
| 20J-16 | 1.5/16"X12 | 1.5/16"X12 | 29.74x2.95 | | 15.1 | 16 | 38.5 | 38 | 41 |
| 20J-16-12 | 1.5/16"X12 | 1.1/16"X12 | 29.74x2.95 | | 15.1 | 15 | 38.5 | 38 | 32 |
| 20J-16-14 | 1.5/16"X12 | 1.3/16"X12 | 29.74x2.95 | | 15.1 | 15 | 38.5 | 38 | 36 |
| 20J-16-20 | 1.5/16"X12 | 1.5/8"X12 | 37.46x3.00 | | 15.1 | 17 | 42 | 41 | 50 |
| 20J-20 | 1.5/8"X12 | 1.5/8"X12 | 37.46x3.00 | | 15.1 | 17 | 46.5 | 50 | 50 |
| 20J-24 | 1.7/8"X12 | 1.7/8"X12 | 43.69x3.00 | | 15.1 | 20 | 48 | 55 | 55 |
| 20J-32 | 2.1/2"X12 | 2.1/2"X12 | 59.36x3.00 | | 15.1 | 24.5 | 50.5 | 70 | 75 |

H

美制螺纹JIC 74° 锥面扩口接头 JIC 74° Cone Flared Tube Fittings

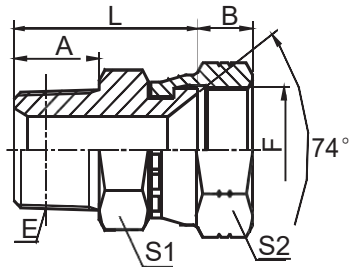

2TJ-SP

英锥管外螺纹 / 美制JIC内螺纹74° 内锥
BSPT MALE / JIC FEMALE 74° SEAT

| 代号 PART NO. | 螺纹 THREAD | | 尺寸 DIMENSIONS | | | | |
|----------------|------------|------------|---------------|------|------|----|----|
| | E | F | A | B | L | S1 | S2 |
| 2TJ-02-04SP | R1/8"X28 | 7/16"X20 | 10 | 9 | 24 | 12 | 17 |
| 2TJ-04SP | R1/4"X19 | 7/16"X20 | 14 | 9 | 28 | 14 | 17 |
| 2TJ-04-05SP | R1/4"X19 | 1/2"X20 | 14 | 9 | 28.5 | 14 | 17 |
| 2TJ-04-06SP | R1/4"X19 | 9/16"X18 | 14 | 10.5 | 28.5 | 14 | 19 |
| 2TJ-06-05SP | R3/8"X19 | 1/2"X20 | 15 | 9 | 29.5 | 19 | 17 |
| 2TJ-06SP | R3/8"X19 | 9/16"X18 | 15 | 10.5 | 29.5 | 17 | 19 |
| 2TJ-06-08SP | R3/8"X19 | 3/4"X16 | 15 | 10.5 | 31.5 | 19 | 24 |
| 2TJ-08SP | R1/2"X14 | 3/4"X16 | 19 | 10.5 | 37.5 | 24 | 24 |
| 2TJ-08-10SP | R1/2"X14 | 7/8"X14 | 19 | 12 | 38 | 24 | 27 |
| 2TJ-08-12SP | R1/2"X14 | 1.1/16"X12 | 20 | 15 | 42.5 | 27 | 32 |
| 2TJ-12SP | R3/4"X14 | 1.1/16"X12 | 19 | 15 | 41.5 | 30 | 32 |
| 2TJ-12-16SP | R3/4"X14 | 1.5/16"X12 | 20 | 16 | 43.5 | 32 | 41 |
| 2TJ-16SP | R1"X11 | 1.5/16"X12 | 24 | 16 | 47.5 | 36 | 41 |
| 2TJ-20SP | R1.1/4"X11 | 1.5/8"X12 | 26.5 | 17 | 55 | 46 | 50 |
| 2TJ-24SP | R1.1/2"X11 | 1.7/8"X12 | 26.5 | 20 | 60 | 50 | 55 |

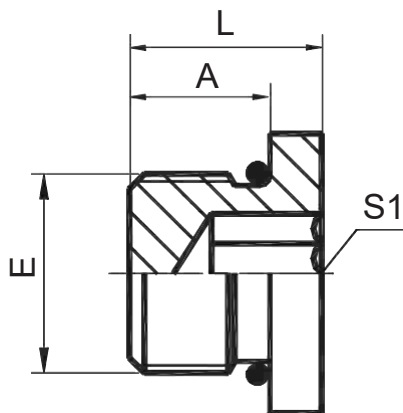

4ON

SAE外螺纹内六角堵头
SAE O-RING BOSS HOLLOW HEX PLUG

| 代号 PART NO. | 螺纹 THREAD | O形圈 O-RING | 尺寸 DIMENSIONS | | | | |
|----------------|------------|------------|---------------|------|----|--|--|
| | E | E端 | A | L | S1 | | |
| 4ON-04 | 7/16"X20 | 8.92X1.83 | 9.1 | 11.5 | 5 | | |
| 4ON-05 | 1/2"X20 | 10.52X1.83 | 9.1 | 11.5 | 5 | | |
| 4ON-06 | 9/16"X18 | 11.89X1.98 | 9.9 | 12.2 | 6 | | |
| 4ON-08 | 3/4"X16 | 16.36X2.21 | 11.1 | 14.3 | 8 | | |
| 4ON-10 | 7/8"X14 | 19.18X2.46 | 12.7 | 16 | 10 | | |
| 4ON-12 | 1.1/16"X12 | 23.47X2.95 | 15.1 | 19 | 14 | | |
| 4ON-16 | 1.5/16"X12 | 29.74X2.95 | 15.1 | 19 | 16 | | |
| 4ON-20 | 1.5/8"X12 | 37.46X3.00 | 15.1 | 19 | 19 | | |

美制螺纹JIC 74° 锥面扩口接头 JIC 74° Cone Flared Tube Fittings

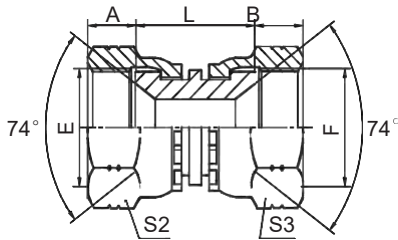

3J

美制JIC内螺纹74° 内锥
JIC FEMALE 74° SEAT

| 代号 PART NO. | 螺纹 THREAD | | 尺寸 DIMENSIONS | | | | |
|----------------|------------|------------|---------------|------|------|----|----|
| | E | F | A | B | L | S2 | S3 |
| 3J-04 | 7/16"X20 | 7/16"X20 | 9 | 9 | 19 | 15 | 15 |
| 3J-04-05 | 7/16"X20 | 1/2"X20 | 9 | 9.5 | 20.5 | 15 | 17 |
| 3J-04-06 | 7/16"X20 | 9/16"X18 | 9 | 10.5 | 20.5 | 15 | 19 |
| 3J-05 | 1/2"X20 | 1/2"X20 | 9.5 | 9.5 | 21 | 17 | 17 |
| 3J-05-06 | 1/2"X20 | 9/16"X18 | 9.5 | 10.5 | 21 | 17 | 19 |
| 3J-06 | 9/16"X18 | 9/16"X18 | 10.5 | 10.5 | 21 | 19 | 19 |
| 3J-06-08 | 9/16"X18 | 3/4"X16 | 10.5 | 11 | 23 | 19 | 24 |
| 3J-08 | 3/4"X16 | 3/4"X16 | 11 | 11 | 26 | 24 | 24 |
| 3J-08-10 | 3/4"X16 | 7/8"X14 | 11 | 13 | 26.5 | 24 | 27 |
| 3J-08-12 | 3/4"X16 | 1.1/16"X12 | 11 | 15 | 28 | 24 | 32 |
| 3J-10 | 7/8"X14 | 7/8"X14 | 13 | 13 | 27 | 27 | 27 |
| 3J-10-12 | 7/8"X14 | 1.1/16"X12 | 13 | 15 | 28 | 27 | 32 |
| 3J-12 | 1.1/16"X12 | 1.1/16"X12 | 15 | 15 | 29 | 32 | 32 |
| 3J-12-14 | 1.1/16"X12 | 1.3/16"X12 | 15 | 15 | 29 | 32 | 36 |
| 3J-12-16 | 1.1/16"X12 | 1.5/16"X12 | 15 | 16 | 29 | 32 | 41 |
| 3J-16 | 1.5/16"X12 | 1.5/16"X12 | 16 | 16 | 29 | 41 | 41 |
| 3J-20 | 1.5/8"X12 | 1.5/8"X12 | 17 | 17 | 35 | 50 | 50 |
| 3J-24 | 1.7/8"X12 | 1.7/8"X12 | 20 | 20 | 37 | 55 | 55 |
| 3J-32 | 2.1/2"X12 | 2.1/2"X12 | 23.5 | 23.5 | 37 | 75 | 75 |

H

美制螺纹JIC 74° 锥面扩口接头 JIC 74° Cone Flared Tube Fittings

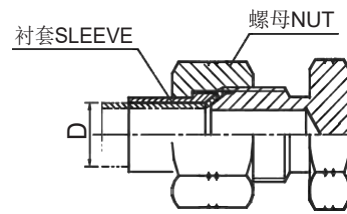
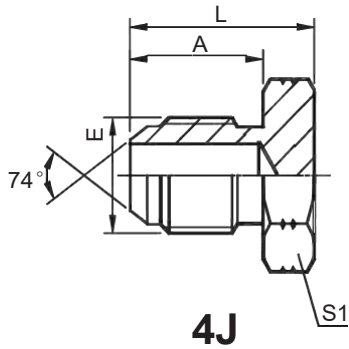

美制JIC外螺纹74° 外锥堵头
JIC MALE 74° CONE PLUG

| 代号 PART NO. | 螺 纹 THREAD | | 尺 寸 DIMENSIONS | | | |
|----------------|------------|--|----------------|------|----|--|
| | E | | A | L | S1 | |
| 4J-02 | 5/16"X24 | | 11.4 | 17.5 | 11 | |
| 4J-03 | 3/8"X24 | | 12.2 | 18 | 11 | |
| 4J-04 | 7/16"X20 | | 14 | 20 | 12 | |
| 4J-05 | 1/2"X20 | | 14 | 20 | 14 | |
| 4J-06 | 9/16"X18 | | 14.1 | 20 | 17 | |
| 4J-08 | 3/4"X16 | | 16.7 | 25 | 22 | |
| 4J-10 | 7/8"X14 | | 19.3 | 27.5 | 24 | |
| 4J-12 | 1.1/16"X12 | | 21.9 | 32 | 30 | |
| 4J-14 | 1.3/16"X12 | | 22.6 | 33.5 | 32 | |
| 4J-16 | 1.5/16"X12 | | 23.1 | 34 | 36 | |
| 4J-20 | 1.5/8"X12 | | 24.3 | 37 | 46 | |
| 4J-24 | 1.7/8"X12 | | 27.5 | 44.5 | 50 | |
| 4J-32 | 2.1/2"X12 | | 33.9 | 51 | 65 | |

注：螺母及衬套需另行订货。管子直径D为公制时，配用螺母及衬套分别选用NB200、NB500。管子直径为英制时，配用螺母及衬套分别选用NB200、NB300。Nut and sleeve should be ordered separately. The nut NB200 and sleeve NB500 is suitable for metric tube, the nut NB200 and sleeve NB300 is suitable for inch tube.

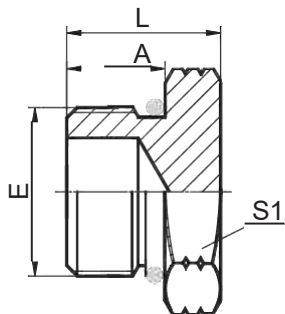

4O

美制SAE外螺纹带O形圈堵头
SAE O-RING BOSS PLUG

| 代号 PART NO. | 螺 纹 THREAD | | O形圈 O-RING | | 尺 寸 DIMENSIONS | | |
|----------------|------------|--|------------|--|----------------|------|----|
| | E | | E端 | | A | L | S1 |
| 4O-02 | 5/16"X24 | | 6.07X1.63 | | 7.54 | 14.6 | 12 |
| 4O-03 | 3/8"X24 | | 7.65X1.63 | | 7.54 | 14.6 | 14 |
| 4O-04 | 7/16"X20 | | 8.92X1.83 | | 9.1 | 16 | 14 |
| 4O-05 | 1/2"X20 | | 10.52X1.83 | | 9.1 | 16 | 17 |
| 4O-06 | 9/16"X18 | | 11.89X1.98 | | 9.9 | 17.5 | 17 |
| 4O-08 | 3/4"X16 | | 16.36X2.21 | | 11.1 | 19.5 | 22 |
| 4O-10 | 7/8"X14 | | 19.18X2.46 | | 12.7 | 23 | 27 |
| 4O-12 | 1.1/16"X12 | | 23.47X2.95 | | 15.1 | 26.5 | 32 |
| 4O-14 | 1.3/16"X12 | | 26.62X2.95 | | 15.1 | 27 | 36 |
| 4O-16 | 1.5/16"X12 | | 29.74X2.95 | | 15.1 | 27.5 | 38 |
| 4O-20 | 1.5/8"X12 | | 37.46X3.00 | | 15.1 | 30 | 50 |
| 4O-24 | 1.7/8"X12 | | 43.69X3.00 | | 15.1 | 30 | 55 |
| 4O-32 | 2.1/2"X12 | | 59.36X3.00 | | 15.1 | 32 | 70 |

美制螺纹JIC 74° 锥面扩口接头 JIC 74° Cone Flared Tube Fittings

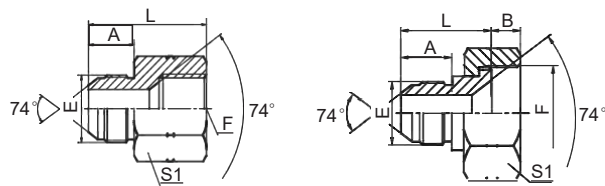

5J

5J-S

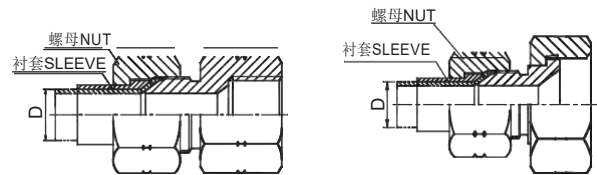

JIC外螺纹74° 外锥 / JIC内螺纹74° 内锥
JIC MALE 74° CONE / JIC FEMALE 74° SEAT

| 代号 PART NO. | 螺 纹 THREAD | | 尺 寸 DIMENSIONS | | | | | |
|----------------|------------|------------|----------------|------|----|------|--|--|
| | E | F | A | L | S1 | B | | |
| 5J-04-05 | 7/16"X20 | 1/2"X20 | 14 | 30.6 | 17 | | | |
| 5J-04-06S | 7/16"X20 | 9/16"X18 | 14 | 26.2 | 19 | 9.8 | | |
| 5J-04-08S | 7/16"X20 | 3/4"X16 | 14 | 26.2 | 24 | 10.9 | | |
| 5J-04-10S | 7/16"X20 | 7/8"X14 | 14 | 28 | 27 | 12.8 | | |
| 5J-04-12S | 7/16"X20 | 1.1/16"X12 | 14 | 29.8 | 32 | 15 | | |
| 5J-04-14S | 7/16"X20 | 1.3/16"X12 | 14 | 32.5 | 36 | 15.2 | | |
| 5J-05-06 | 1/2"X20 | 9/16"X18 | 14 | 33.7 | 19 | | | |
| 5J-05-08S | 1/2"X20 | 3/4"X16 | 14 | 26.2 | 24 | 10.9 | | |
| 5J-05-10S | 1/2"X20 | 7/8"X14 | 14 | 28 | 27 | 12.8 | | |
| 5J-05-12S | 1/2"X20 | 1.1/16"X12 | 14 | 29.8 | 32 | 15 | | |
| 5J-06-04 | 9/16"X18 | 7/16"X20 | 14.1 | 30.6 | 17 | | | |
| 5J-06-08S | 9/16"X18 | 3/4"X16 | 14.1 | 26.3 | 24 | 10.9 | | |
| 5J-06-10S | 9/16"X18 | 7/8"X14 | 14.1 | 28.2 | 27 | 12.8 | | |
| 5J-06-12S | 9/16"X18 | 1.1/16"X12 | 14.1 | 30.1 | 32 | 15 | | |
| 5J-06-14S | 9/16"X18 | 1.3/16"X12 | 14.1 | 32.5 | 36 | 15.2 | | |
| 5J-06-16S | 9/16"X18 | 1.5/16"X12 | 14.1 | 33 | 38 | 15.9 | | |
| 5J-08-04 | 3/4"X16 | 7/16"X20 | 16.7 | 33 | 22 | | | |
| 5J-08-06 | 3/4"X16 | 9/16"X18 | 16.7 | 36.5 | 22 | | | |
| 5J-08-10 | 3/4"X16 | 7/8"X14 | 16.7 | 36.2 | 30 | | | |
| 5J-08-12S | 3/4"X16 | 1.1/16"X12 | 16.7 | 33.3 | 32 | 15 | | |
| 5J-08-14S | 3/4"X16 | 1.3/16"X12 | 16.7 | 35 | 36 | 15.2 | | |
| 5J-08-16S | 3/4"X16 | 1.5/16"X12 | 16.7 | 35.6 | 38 | 15.9 | | |
| 5J-08-20S | 3/4"X16 | 1.5/8"X12 | 16.7 | 35.5 | 50 | 16.8 | | |
| 5J-10-08 | 7/8"X14 | 3/4"X16 | 19.3 | 40.5 | 24 | | | |
| 5J-10-12 | 7/8"X14 | 1.1/16"X12 | 19.3 | 45.1 | 32 | | | |
| 5J-10-16S | 7/8"X14 | 1.5/16"X12 | 19.3 | 37.5 | 38 | 15.9 | | |
| 5J-10-20S | 7/8"X14 | 1.5/8"X12 | 19.3 | 37.9 | 50 | 16.8 | | |
| 5J-10-24S | 7/8"X14 | 1.7/8"X12 | 19.3 | 42 | 60 | 19.7 | | |
| 5J-12-08 | 1.1/16"X12 | 3/4"X16 | 21.9 | 43 | 30 | | | |
| 5J-12-10 | 1.1/16"X12 | 7/8"X14 | 21.9 | 43 | 30 | | | |
| 5J-12-16S | 1.1/16"X12 | 1.5/16"X12 | 22 | 40.2 | 38 | 15.9 | | |
| 5J-12-20S | 1.1/16"X12 | 1.5/8"X12 | 22 | 40.6 | 50 | 16.8 | | |
| 5J-12-24S | 1.1/16"X12 | 1.7/8"X12 | 22 | 42 | 60 | 19.7 | | |
| 5J-16-08 | 1.5/16"X12 | 3/4"X16 | 23.1 | 44 | 36 | | | |
| 5J-16-10 | 1.5/16"X12 | 7/8"X14 | 23.1 | 44 | 36 | | | |
| 5J-16-12 | 1.5/16"X12 | 1.1/16"X12 | 23.1 | 50 | 36 | | | |
| 5J-16-20S | 1.5/16"X12 | 1.5/8"X12 | 23 | 41.8 | 50 | 16.8 | | |
| 5J-16-24S | 1.5/16"X12 | 1.7/8"X12 | 23 | 43.2 | 60 | 19.7 | | |
| 5J-16-32S | 1.5/16"X12 | 2.1/2"X12 | 23 | 49 | 75 | 29.1 | | |
| 5J-20-12 | 1.5/8"X12 | 1.1/16"X12 | 24.3 | 50 | 46 | | | |
| 5J-20-16 | 1.5/8"X12 | 1.5/16"X12 | 24.3 | 50 | 46 | | | |
| 5J-20-24S | 1.5/8"X12 | 1.7/8"X12 | 24.3 | 44.3 | 60 | 19.7 | | |
| 5J-20-32S | 1.5/8"X12 | 2.1/2"X12 | 24.3 | 50 | 75 | 29.1 | | |
| 5J-24-20 | 1.7/8"X12 | 1.5/8"X12 | 27.5 | 56 | 50 | | | |

注：螺母及衬套需另行订货。管子直径D为公制时，配用螺母及衬套分别选用NB200、NB500。管子直径为英制时，配用螺母及衬套分别选用NB200、NB300。 Nut and sleeve should be ordered separately. The nut NB200 and sleeve NB500 is suitable for metric tube, the nut NB200 and sleeve NB300 is suitable for inch tube.

H

美制螺纹JIC 74° 锥面扩口接头 JIC 74° Cone Flared Tube Fittings

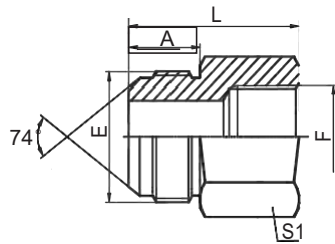

5JB

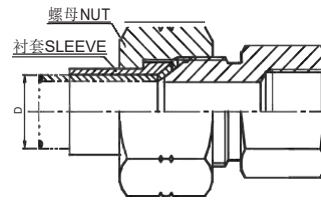

JIC外螺纹74° 外锥 / 英管内螺纹 JIC MALE 74° CONE / BSP FEMALE

| 代号 PART NO. | 螺 纹 THREAD | | 尺 寸 DIMENSIONS | | | |
|----------------|------------|------------|----------------|------|----|--|
| | E | F | A | L | S1 | |
| 5JB-04 | 7/16"X20 | G1/4"X19 | 14 | 33 | 19 | |
| 5JB-04-02 | 7/16"X20 | G1/8"X28 | 14 | 31 | 14 | |
| 5JB-04-06 | 7/16"X20 | G3/8"X19 | 14 | 35.5 | 22 | |
| 5JB-04-08 | 7/16"X20 | G1/2"X14 | 14 | 40 | 27 | |
| 5JB-06 | 9/16"X18 | G3/8"X19 | 14.1 | 35 | 22 | |
| 5JB-06-04 | 9/16"X18 | G1/4"X19 | 14.1 | 34 | 19 | |
| 5JB-06-08 | 9/16"X18 | G1/2"X14 | 14.4 | 39.5 | 27 | |
| 5JB-06-10 | 9/16"X18 | G5/8"X14 | 14.4 | 43.4 | 30 | |
| 5JB-08 | 3/4"X16 | G1/2"X14 | 16.7 | 44 | 30 | |
| 5JB-08-04 | 3/4"X16 | G1/4"X19 | 16.7 | 35 | 22 | |
| 5JB-08-06 | 3/4"X16 | G3/8"X19 | 16.7 | 40 | 22 | |
| 5JB-08-10 | 3/4"X16 | G5/8"X14 | 16.7 | 45.7 | 30 | |
| 5JB-08-12 | 3/4"X16 | G3/4"X14 | 16.7 | 46 | 32 | |
| 5JB-10-08 | 7/8"X14 | G1/2"X14 | 19.3 | 45 | 27 | |
| 5JB-10-12 | 7/8"X14 | G3/4"X14 | 19.3 | 48.3 | 32 | |
| 5JB-12 | 1.1/16"X12 | G3/4"X14 | 21.9 | 50 | 36 | |
| 5JB-12-08 | 1.1/16"X12 | G1/2"X14 | 21.9 | 48 | 30 | |
| 5JB-12-10 | 1.1/16"X12 | G5/8"X14 | 21.9 | 51.1 | 30 | |
| 5JB-12-16 | 1.1/16"X12 | G1"X11 | 21.9 | 53 | 41 | |
| 5JB-16 | 1.5/16"X12 | G1"X11 | 23.1 | 52.5 | 41 | |
| 5JB-16-12 | 1.5/16"X12 | G3/4"X14 | 23.1 | 50 | 36 | |
| 5JB-16-20 | 1.5/16"X12 | G1.1/4"X11 | 23.1 | 57 | 50 | |
| 5JB-16-24 | 1.5/16"X12 | G1.1/2"X11 | 23.1 | 59.6 | 55 | |
| 5JB-20 | 1.5/8"X12 | G1.1/4"X11 | 24.3 | 57 | 50 | |
| 5JB-20-16 | 1.5/8"X12 | G1"X11 | 24.3 | 55 | 46 | |
| 5JB-20-24 | 1.5/8"X12 | G1.1/2"X11 | 24.3 | 64.8 | 55 | |
| 5JB-24 | 1.7/8"X12 | G1.1/2"X11 | 27.5 | 62 | 55 | |
| 5JB-24-20 | 1.7/8"X12 | G1.1/4"X11 | 27.5 | 56 | 50 | |
| 5JB-24-32 | 1.7/8"X12 | G2"X11 | 27.5 | 68 | 70 | |
| 5JB-32 | 2.1/2"X12 | G2"X11 | 33.9 | 67 | 70 | |

注：螺母及衬套需另行订货。管子直径D为公制时，配用螺母及衬套分别选用NB200、NB500。管子直径为英制时，配用螺母及衬套分别选用NB200、NB300。Nut and sleeve should be ordered separately. The nut NB200 and sleeve NB500 is suitable for metric tube, the nut NB200 and sleeve NB300 is suitable for inch tube.

美制螺纹JIC 74° 锥面扩口接头 JIC 74° Cone Flared Tube Fittings

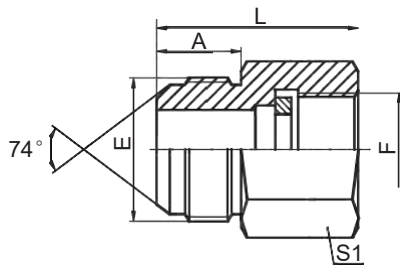

5JB-G

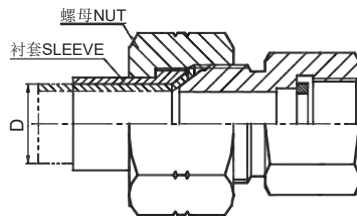

JIC外螺纹

74° 外锥 / 英管内螺纹表接头

JIC MALE 74° CONE / BSP

PRESSURE GAUGE CONNECTOR

| 代号 PART NO. | 螺 纹 THREAD | | 紫铜片 COPPER WASHER | | 尺 寸 DIMENSIONS | | | | |
|----------------|------------|----------|-------------------|---------|----------------|------|----|--|--|
| | E | F | | F端 | A | L | S1 | | |
| 5JB-04-08G | 7/16"X20 | G1/2"X14 | | DP-B08G | 14 | 41 | 27 | | |
| 5JB-04G | 7/16"X20 | G1/4"X19 | | DP-B04G | 14 | 32 | 19 | | |
| 5JB-05-04G | 1/2"X20 | G1/4"X19 | | DP-B04G | 14 | 28 | 19 | | |
| 5JB-05-08G | 1/2"X20 | G1/2"X14 | | DP-B08G | 14 | 41 | 27 | | |
| 5JB-06-04G | 9/16"X18 | G1/4"X19 | | DP-B04G | 14.1 | 28.1 | 19 | | |
| 5JB-06-08G | 9/16"X18 | G1/2"X14 | | DP-B08G | 14.1 | 35.5 | 27 | | |
| 5JB-08-04G | 3/4"X16 | G1/4"X19 | | DP-B04G | 16.7 | 31 | 22 | | |
| 5JB-08G | 3/4"X16 | G1/2"X14 | | DP-B08G | 16.7 | 38 | 27 | | |
| 5JB-10-08G | 7/8"X14 | G1/2"X14 | | DP-B08G | 19.3 | 40.5 | 27 | | |
| 5JB-12-08G | 1.1/16"X12 | G1/2"X14 | | DP-B08G | 21.9 | 43 | 30 | | |

注：螺母及衬套需另行订货。管子直径D为公制时，配用螺母及衬套分别选用NB200、NB500。管子直径为英制时，配用螺母及衬套分别选用NB200、NB300。Nut and sleeve should be ordered separately.The nut NB200 and sleeve NB500 is suitable for metric tube,the nut NB200 and sleeve NB300 is suitable for inch tube.

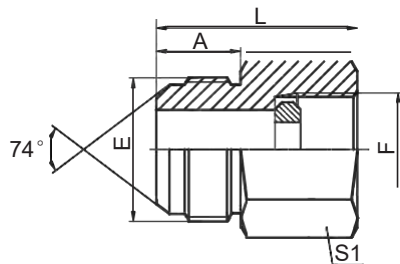

5JB-GDK

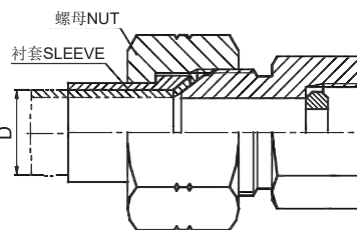

JIC外螺纹

74° 外锥 / 英管内螺纹表接头

JIC MALE 74° CONE / BSP

PRESSURE GAUGE CONNECTOR

| 代号 PART NO. | 螺 纹 THREAD | | 密封钢垫 SEALING RING DK1 | | 尺 寸 DIMENSIONS | | | | |
|----------------|------------|----------|-----------------------|----------|----------------|------|----|--|--|
| | E | F | | F端 | A | L | S1 | | |
| 5JB-04GDK | 7/16"X20 | G1/4"X19 | | DP-B04DK | 14 | 33.5 | 19 | | |
| 5JB-05-04GDK | 1/2"X20 | G1/4"X19 | | DP-B04DK | 14 | 33 | 19 | | |
| 5JB-06-04GDK | 9/16"X18 | G1/4"X19 | | DP-B04DK | 14.1 | 33 | 19 | | |
| 5JB-10-08GDK | 7/8"X14 | G1/2"X14 | | DP-B08DK | 19.3 | 45.5 | 27 | | |
| 5JB-12-08GDK | 1.1/16"X12 | G1/2"X14 | | DP-B08DK | 21.9 | 48 | 30 | | |

注：螺母及衬套需另行订货。管子直径D为公制时，配用螺母及衬套分别选用NB200、NB500。管子直径为英制时，配用螺母及衬套分别选用NB200、NB300。Nut and sleeve should be ordered separately.The nut NB200 and sleeve NB500 is suitable for metric tube,the nut NB200 and sleeve NB300 is suitable for inch tube.

H

美制螺纹JIC 74° 锥面扩口接头 JIC 74° Cone Flared Tube Fittings

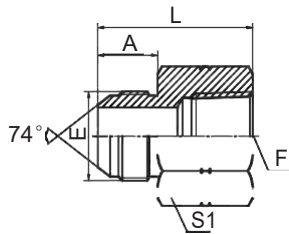

5JN

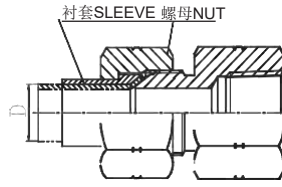

美制JIC外螺纹
74° 外锥 / 布锥管内螺纹
JIC MALE
74° CONE / NPT FEMALE

| 代号 PART NO. | 螺 纹 THREAD | | 尺 寸 DIMENSIONS | | | |
|----------------|------------|--------------|----------------|------|----|--|
| | E | F | A | L | S1 | |
| 5JN-04-02 | 7/16"X20 | Z1/8"X27 | 14 | 30 | 17 | |
| 5JN-04 | 7/16"X20 | Z1/4"X18 | 14 | 35.5 | 19 | |
| 5JN-05-04 | 1/2"X20 | Z1/4"X18 | 14 | 35.3 | 19 | |
| 5JN-06-04 | 9/16"X18 | Z1/4"X18 | 14.1 | 35.6 | 19 | |
| 5JN-06 | 9/16"X18 | Z3/8"X18 | 14.1 | 37.1 | 22 | |
| 5JN-06-08 | 9/16"X18 | Z1/2"X14 | 14.1 | 42.5 | 30 | |
| 5JN-08-06 | 3/4"X16 | Z3/8"X18 | 16.7 | 39.6 | 22 | |
| 5JN-08 | 3/4"X16 | Z1/2"X14 | 16.7 | 45.6 | 30 | |
| 5JN-08-12 | 3/4"X16 | Z3/4"X14 | 16.7 | 45 | 36 | |
| 5JN-10-08 | 7/8"X14 | Z1/2"X14 | 19.3 | 48 | 30 | |
| 5JN-10-12 | 7/8"X14 | Z3/4"X14 | 19.3 | 49.7 | 36 | |
| 5JN-12-08 | 1.1/16"X12 | Z1/2"X14 | 21.9 | 52.1 | 30 | |
| 5JN-12 | 1.1/16"X12 | Z3/4"X14 | 21.9 | 52.3 | 36 | |
| 5JN-16-12 | 1.5/16"X12 | Z3/4"X14 | 23.1 | 50 | 36 | |
| 5JN-16 | 1.5/16"X12 | Z1"X11.5 | 23.1 | 59 | 41 | |
| 5JN-20 | 1.5/8"X12 | Z1.1/4"X11.5 | 24.3 | 61.5 | 50 | |
| 5JN-24 | 1.7/8"X12 | Z1.1/2"X11.5 | 27.5 | 62.5 | 60 | |
| 5JN-32 | 2.1/2"X12 | Z2"X11.5 | 33.9 | 70 | 70 | |

注：螺母及衬套需另行订货。管子直径D为公制时，配用螺母及衬套分别选用NB200、NB500。管子直径为英制时，配用螺母及衬套分别选用NB200、NB300。 Note: Nut and sleeve should be ordered separately. The nut NB200 and sleeve NB500 is suitable for metric tube, the nut NB200 and sleeve NB300 is suitable for inch tube.

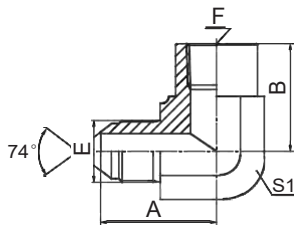

5JN9

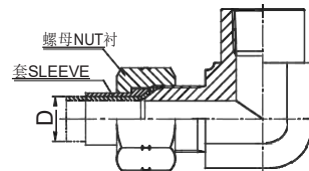

90° 弯JIC外螺纹74° 外锥 / 布锥管内螺纹
90° ELBOW JIC MALE 74° CONE / NPT FEMALE

| 代号 PART NO. | 螺 纹 THREAD | | 尺 寸 DIMENSIONS | | | |
|----------------|------------|--------------|----------------|------|----|--|
| | E | F | A | B | S1 | |
| 5JN9-04-02 | 7/16"X20 | Z1/8"X27 | 27.5 | 16.8 | 16 | |
| 5JN9-04 | 7/16"X20 | Z1/4"X18 | 30.9 | 22.4 | 19 | |
| 5JN9-06-04 | 9/16"X18 | Z1/4"X18 | 31.2 | 22.4 | 19 | |
| 5JN9-06 | 9/16"X18 | Z3/8"X18 | 33.5 | 25.9 | 24 | |
| 5JN9-08-04 | 3/4"X16 | Z1/4"X18 | 31.6 | 22.4 | 19 | |
| 5JN9-08 | 3/4"X16 | Z1/2"X14 | 39.5 | 31.2 | 30 | |
| 5JN9-12-08 | 1.1/16"X12 | Z1/2"X14 | 46 | 31.2 | 30 | |
| 5JN9-12 | 1.1/16"X12 | Z3/4"X14 | 48 | 34.5 | 33 | |
| 5JN9-12-16 | 1.1/16"X12 | Z1"X11.5 | 52.5 | 41.1 | 41 | |
| 5JN9-16-12 | 1.5/16"X12 | Z3/4"X14 | 49 | 34.5 | 33 | |
| 5JN9-16 | 1.5/16"X12 | Z1"X11.5 | 55.1 | 41.1 | 41 | |
| 5JN9-20 | 1.5/8"X12 | Z1.1/4"X11.5 | 59.2 | 43.2 | 48 | |
| 5JN9-24 | 1.7/8"X12 | Z1.1/2"X11.5 | 73.4 | 52.8 | 63 | |

注：螺母及衬套需另行订货。管子直径D为公制时，配用螺母及衬套分别选用NB200、NB500。管子直径为英制时，配用螺母及衬套分别选用NB200、NB300。 Note: Nut and sleeve should be ordered separately. The nut NB200 and sleeve NB500 is suitable for metric tube, the nut NB200 and sleeve NB300 is suitable for inch tube.

美制螺纹JIC 74° 锥面扩口接头 JIC 74° Cone Flared Tube Fittings

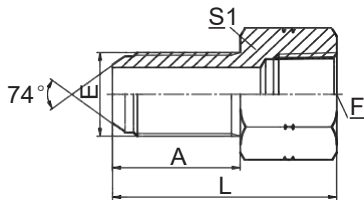

5JN-BH

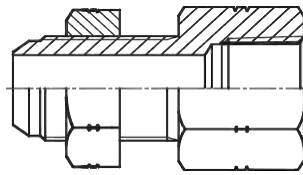

5JN-BH(LN)

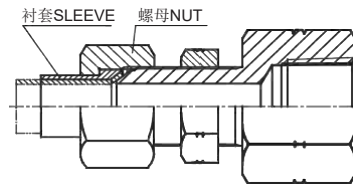

美制JIC外螺纹
过板接头 / 布锥管内螺纹
JIC MALE
BULKHEAD / NPT FEMALE

| 代号 PART NO. | 螺纹 THREAD | | 尺寸 DIMENSIONS | | | | | |
|----------------|------------|--------------|---------------|------|----|--|--|--|
| | E | F | A | L | S1 | | | |
| 5JN-04-02BH | 7/16"X20 | Z1/8"X27 | 32.5 | 48.5 | 17 | | | |
| 5JN-04BH | 7/16"X20 | Z1/4"X18 | 32.5 | 54 | 19 | | | |
| 5JN-06-04BH | 9/16"X18 | Z1/4"X18 | 32.5 | 54 | 19 | | | |
| 5JN-08-06BH | 3/4"X16 | Z3/8"X18 | 36.5 | 59.5 | 22 | | | |
| 5JN-10-08BH | 7/8"X14 | Z1/2"X14 | 40 | 68.5 | 30 | | | |
| 5JN-10-12BH | 7/8"X14 | Z3/4"X14 | 40 | 70.5 | 32 | | | |
| 5JN-12-06BH | 1.1/16"X12 | Z3/8"X18 | 44.5 | 68.5 | 36 | | | |
| 5JN-12-08BH | 1.1/16"X12 | Z1/2"X14 | 44.5 | 69.5 | 36 | | | |
| 5JN-12BH | 1.1/16"X12 | Z3/4"X14 | 44.5 | 75 | 36 | | | |
| 5JN-14-12BH | 1.3/16"X12 | Z3/4"X14 | 44.5 | 75 | 41 | | | |
| 5JN-16-12BH | 1.5/16"X12 | Z3/4"X14 | 44.5 | 71.5 | 41 | | | |
| 5JN-16BH | 1.5/16"X12 | Z1"X11.5 | 44.5 | 81 | 41 | | | |
| 5JN-20BH | 1.5/8"X12 | Z1.1/4"X11.5 | 45.7 | 83 | 50 | | | |
| 5JN-24BH | 1.7/8"X12 | Z1.1/2"X11.5 | 46 | 83.5 | 55 | | | |

H

美制螺纹JIC 74° 锥面扩口接头 JIC 74° Cone Flared Tube Fittings

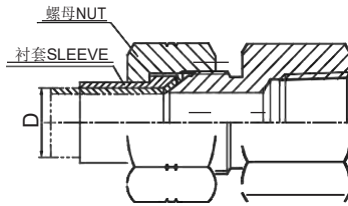
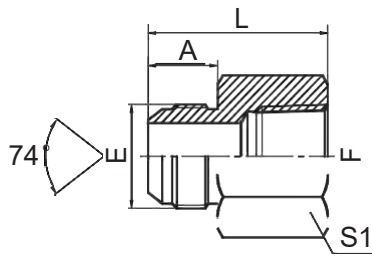

美制JIC外螺纹
74° 外锥 / 英锥管内螺纹
JIC MALE
74° CONE / BSPT FEMALE

5JT

| 代号 PART NO. | 螺 纹 THREAD | | 尺 寸 DIMENSIONS | | | |
|----------------|------------|-----------|----------------|------|----|--|
| | E | F | A | L | S1 | |
| 5JT-04-02 | 7/16"X20 | Rc1/8"X28 | 14 | 30 | 14 | |
| 5JT-04 | 7/16"X20 | Rc1/4"X19 | 14 | 35.5 | 19 | |
| 5JT-06-04 | 9/16"X18 | Rc1/4"X19 | 14 | 35.5 | 19 | |
| 5JT-06 | 9/16"X18 | RC3/8"X19 | 14 | 36.5 | 22 | |
| 5JT-08-06 | 3/4"X16 | RC3/8"X19 | 16.7 | 39.5 | 22 | |
| 5JT-08 | 3/4"X16 | Rc1/2"X14 | 16.7 | 45.5 | 27 | |
| 5JT-10-08 | 7/8"X14 | Rc1/2"X14 | 19.3 | 48 | 27 | |
| 5JT-12 | 1.1/16"X12 | Rc3/4"X14 | 22 | 52.5 | 36 | |
| 5JT-16 | 1.5/16"X12 | Rc1"X11 | 23 | 59 | 41 | |

注：螺母及衬套需另行订货。管子直径D为公制时，配用螺母及衬套分别选用 NB200、NB500。管子直径为英制时，配用螺母及衬套分别选用 NB200、NB300。 Note: Nut and sleeve should be ordered separately. The nut NB200 and sleeve NB500 is suitable for metric tube, the nut NB200 and sleeve NB300 is suitable for inch tube.

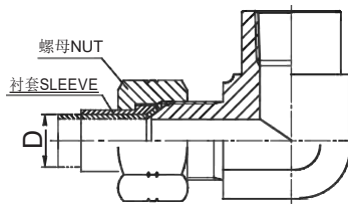
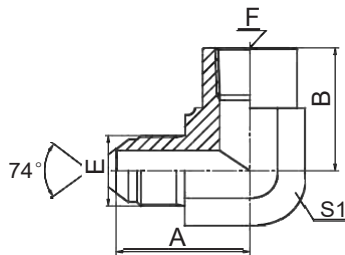

90° JIC外螺纹
74° 外锥 / 英锥管内螺纹
90° JIC MALE
74° CONE / BSPT FEMALE

5JT9

| 代号 PART NO. | 螺 纹 THREAD | | 尺 寸 DIMENSIONS | | | |
|----------------|------------|-------------|----------------|------|----|--|
| | E | F | A | B | S1 | |
| 5JT9-04-02 | 7/16"x20 | Rc1/8"X28 | 27.5 | 20 | 16 | |
| 5JT9-04 | 7/16"x20 | Rc1/4"X19 | 30 | 25 | 19 | |
| 5JT9-05-04 | 1/2"X20 | Rc1/4"X19 | 30 | 25 | 19 | |
| 5JT9-06 | 9/16"X18 | Rc3/8"X19 | 33.5 | 27 | 24 | |
| 5JT9-06-04 | 9/16"X18 | Rc1/4"X19 | 30.5 | 25 | 19 | |
| 5JT9-08 | 3/4"X16 | Rc1/2"X14 | 39.5 | 31.5 | 30 | |
| 5JT9-08-06 | 3/4"X16 | Rc3/8"X19 | 36 | 27 | 24 | |
| 5JT9-10-08 | 7/8"X14 | Rc1/2"X14 | 42.5 | 31.5 | 30 | |
| 5JT9-12 | 1.1/16"X12 | Rc3/4"X14 | 48 | 37 | 33 | |
| 5JT9-12-08 | 1.1/16"X12 | Rc1/2"X14 | 46.2 | 31.5 | 30 | |
| 5JT9-16 | 1.5/16"X12 | Rc1"X11 | 54 | 43 | 41 | |
| 5JT9-20 | 1.5/8"X12 | Rc1.1/4"X11 | 62 | 46 | 50 | |
| 5JT9-24 | 1.7/8"X12 | Rc1.1/2"X11 | 74.5 | 55 | 63 | |

注：螺母及衬套需另行订货。管子直径D为公制时，配用螺母及衬套分别选用NB200、NB500。管子直径为英制时，配用螺母及衬套分别选用 NB200、NB300。 Nut and sleeve should be ordered separately. The nut NB200 and sleeve NB500 is suitable for metric tube, the nut NB200 and sleeve NB300 is suitable for inch tube.

美制螺纹JIC 74° 锥面扩口接头 JIC 74° Cone Flared Tube Fittings

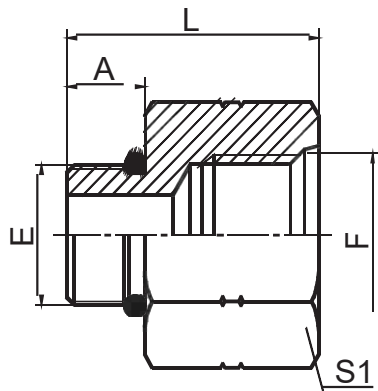

50

美制SAE外螺纹带O形圈轻系列
 ISO 11926-3 / 美制SAE内螺纹ISO 11926-1
 SAE O-RING BOSS L-SERIES
 ISO 11926-3 / SAE FEMALE ISO 11926-1

| 代号 PART NO. | 螺纹 THREAD | | O形圈 O-RING | | 尺寸 DIMENSIONS | | | | |
|----------------|------------|------------|------------|--|---------------|------|----|--|--|
| | E | F | E端 | | A | L | S1 | | |
| 50-04-06 | 7/16"X20 | 9/16"X18 | O904 | | 9.14 | 31 | 22 | | |
| 50-06-04 | 9/16"X18 | 7/16"X20 | O906 | | 9.93 | 28 | 17 | | |
| 50-06-08 | 9/16"X18 | 3/4"X16 | O906 | | 9.93 | 36 | 27 | | |
| 50-08-06 | 3/4"X16 | 9/16"X18 | O908 | | 11.13 | 31.5 | 22 | | |
| 50-08-10 | 3/4"X16 | 7/8"X14 | O908 | | 11.13 | 38 | 30 | | |
| 50-08-12 | 3/4"X16 | 1.1/16"X12 | O908 | | 11.13 | 43 | 32 | | |
| 50-10 | 7/8"X14 | 7/8"X14 | O910 | | 12.7 | 41 | 30 | | |
| 50-10-06 | 7/8"X14 | 9/16"X18 | O910 | | 12.7 | 20.6 | 27 | | |
| 50-10-08 | 7/8"X14 | 3/4"X16 | O910 | | 12.7 | 35 | 27 | | |
| 50-10-12 | 7/8"X14 | 1.1/16"X12 | O910 | | 12.7 | 43 | 36 | | |
| 50-12-08 | 1.1/16"X12 | 3/4"X16 | O912 | | 15.09 | 26 | 32 | | |
| 50-12-10 | 1.1/16"X12 | 7/8"X14 | O912 | | 15.1 | 40.5 | 32 | | |
| 50-12-16 | 1.1/16"X12 | 1.5/16"X12 | O912 | | 15.1 | 46 | 41 | | |
| 50-14-12 | 1.3/16"X12 | 1.1/16"X12 | O914 | | 15.1 | 43 | 36 | | |
| 50-16-06 | 1.5/16"X12 | 9/16"X18 | O916 | | 15.1 | 26 | 38 | | |
| 50-16-10 | 1.5/16"X12 | 7/8"X14 | O916 | | 15.1 | 26 | 38 | | |
| 50-16-12 | 1.5/16"X12 | 1.1/16"X12 | O916 | | 15.1 | 43.5 | 38 | | |
| 50-16-14 | 1.5/16"X12 | 1.3/16"X12 | O916 | | 15.1 | 43 | 38 | | |
| 50-16-20 | 1.5/16"X12 | 1.5/8"X12 | O916 | | 15.1 | 46.5 | 50 | | |
| 50-20-12 | 1.5/8"X12 | 1.1/16"X12 | O920 | | 15.1 | 35 | 50 | | |
| 50-20-16 | 1.5/8"X12 | 1.5/16"X12 | O920 | | 15.1 | 42 | 50 | | |
| 50-20-24 | 1.5/8"X12 | 1.7/8"X12 | O920 | | 15.1 | 48 | 55 | | |
| 50-24-16 | 1.7/8"X12 | 1.5/16"X12 | O924 | | 15.1 | 35 | 55 | | |
| 50-24-20 | 1.7/8"X12 | 1.5/8"X12 | O924 | | 15.1 | 45 | 55 | | |
| 50-32-20 | 2.1/2"X12 | 1.5/8"X12 | O932 | | 15.1 | 32 | 70 | | |
| 50-32-24 | 2.1/2"X12 | 1.7/8"X12 | O932 | | 15.1 | 32 | 70 | | |

H

美制螺纹JIC 74° 锥面扩口接头 JIC 74° Cone Flared Tube Fittings

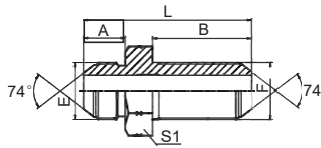

6J

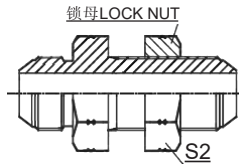

6J-LN

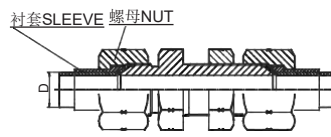

美制JIC外螺纹74° 外锥过板接头
JIC MALE 74° CONE BULKHEAD

| 代号 PART NO. | 螺 纹 THREAD | | 尺 寸 DIMENSIONS | | | | | |
|----------------|------------|------------|----------------|------|-------|----|----|--|
| | E | F | A | B | L | S1 | S2 | |
| 6J-02 | 5/16"X24 | 5/16"X24 | 11.4 | 28.2 | 47.5 | 14 | 14 | |
| 6J-03 | 3/8"X24 | 3/8"X24 | 12.2 | 28.2 | 48.3 | 16 | 16 | |
| 6J-04 | 7/16"X20 | 7/16"X20 | 14 | 32.5 | 52.5 | 17 | 17 | |
| 6J-05 | 1/2"X20 | 1/2"X20 | 14 | 32.5 | 52.5 | 19 | 19 | |
| 6J-06 | 9/16"X18 | 9/16"X18 | 14.1 | 32.5 | 54.5 | 22 | 22 | |
| 6J-06(S19) | 9/16"X18 | 9/16"X18 | 14.1 | 32.5 | 54.5 | 19 | 22 | |
| 6J-08 | 3/4"X16 | 3/4"X16 | 16.7 | 36.5 | 61.5 | 24 | 24 | |
| 6J-10 | 7/8"X14 | 7/8"X14 | 19.3 | 40 | 69.5 | 30 | 30 | |
| 6J-12 | 1.1/16"X12 | 1.1/16"X12 | 21.9 | 44.5 | 78.5 | 36 | 36 | |
| 6J-14 | 1.3/16"X12 | 1.3/16"X12 | 22.6 | 44.5 | 79.2 | 38 | 38 | |
| 6J-16 | 1.5/16"X12 | 1.5/16"X12 | 23.1 | 44.5 | 79.8 | 41 | 41 | |
| 6J-20 | 1.5/8"X12 | 1.5/8"X12 | 24.3 | 45.7 | 84 | 50 | 50 | |
| 6J-24 | 1.7/8"X12 | 1.7/8"X12 | 27.5 | 46 | 89.5 | 55 | 55 | |
| 6J-32 | 2.1/2"X12 | 2.1/2"X12 | 33.9 | 53.1 | 106.7 | 70 | 70 | |

注：如需带锁母订货，则请在代号后加“LN”，如6J-12LN。螺母及衬套需另行订货，管子直径D为公制时，配用螺母及衬套分别选用NB200、NB500。管子直径为英制时，配用螺母及衬套分别选用NB200、NB300。

Note: In case if you are interested to order the adapter with lock nut, please insert suffix "LN" after our part no. , for example 6J-12LN. Nut and sleeve should be ordered separately, The nut NB200 and sleeve NB500 is suitable for metric tube, the nut NB200 and sleeve NB300 is suitable for inch tube.

美制螺纹JIC 74° 锥面扩口接头 JIC 74° Cone Flared Tube Fittings

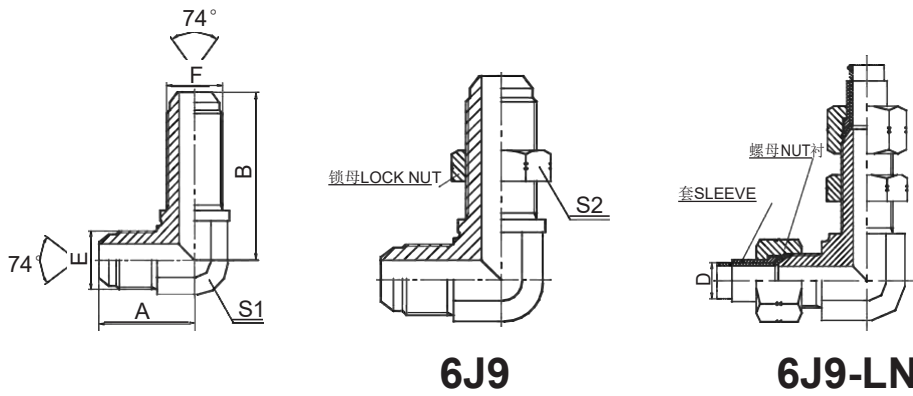

6J9

6J9-LN

90° JIC外螺纹74° 外锥过板接头
90° JIC MALE 74° CONE BULKHEAD

| 代号 PART NO. | 螺纹 THREAD | | 尺寸 DIMENSIONS | | | | |
|----------------|------------|------------|---------------|------|----|----|--|
| | E | F | A | B | S1 | S2 | |
| 6J9-04 | 7/16"X20 | 7/16"X20 | 24.5 | 40.4 | 11 | 17 | |
| 6J9-05 | 1/2"X20 | 1/2"X20 | 26.6 | 43.7 | 14 | 19 | |
| 6J9-06 | 9/16"X18 | 9/16"X18 | 27.7 | 46 | 14 | 22 | |
| 6J9-08 | 3/4"X16 | 3/4"X16 | 34.5 | 53.5 | 19 | 24 | |
| 6J9-10 | 7/8"X14 | 7/8"X14 | 39.6 | 60.7 | 22 | 30 | |
| 6J9-12 | 1.1/16"X12 | 1.1/16"X12 | 45.2 | 67.8 | 27 | 36 | |
| 6J9-14 | 1.3/16"X12 | 1.3/16"X12 | 48.2 | 69.5 | 30 | 38 | |
| 6J9-16 | 1.5/16"X12 | 1.5/16"X12 | 50 | 71 | 33 | 41 | |
| 6J9-20 | 1.5/8"X12 | 1.5/8"X12 | 57.5 | 79.2 | 41 | 50 | |
| 6J9-24 | 1.7/8"X12 | 1.7/8"X12 | 62.5 | 86.9 | 48 | 55 | |

注：如需带锁母订货，则请在代号后加“LN”，如6J9-12LN。螺母及衬套需另行订货，管子直径D为公制时，配用螺母及衬套分别选用NB200、NB500。管子直径为英制时，配用螺母及衬套分别选用NB200、NB300。

Note: In case if you are interested to order the adapter with lock nut, please insert suffix "LN" after our part no , for example 6J9-12LN . Nut and sleeve should be ordered separately, The nut NB200 and sleeve NB500 is suitable for metric tube, the nut NB200 and sleeve NB300 is suitable for inch tube.

H

美制螺纹JIC 74° 锥面扩口接头 JIC 74° Cone Flared Tube Fittings

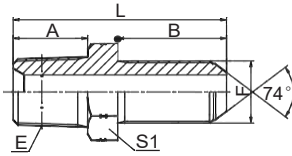

6NJ

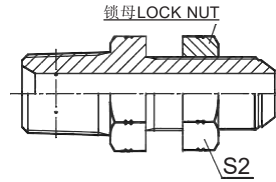

6NJ-LN

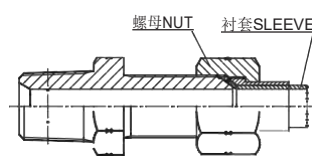

美制NPT外螺纹/ 美制
JIC外螺纹外锥过板接头
NPT MALE/JIC MALE 74° Cone Bulkhead

| 代号 PART NO. | 螺 纹 THREAD | | 尺 寸 DIMENSIONS | | | | | |
|----------------|--------------|------------|----------------|------|------|----|----|--|
| | E | F | A | B | L | S1 | S2 | |
| 6NJ-02-04 | Z1/8"X27 | 7/16"X20 | 10.5 | 32.5 | 49 | 17 | 17 | |
| 6NJ-04 | Z1/4"X18 | 7/16"X20 | 15 | 32.5 | 53.5 | 17 | 17 | |
| 6NJ-04-06 | Z1/4"X18 | 9/16"X18 | 15 | 32.5 | 53.5 | 22 | 22 | |
| 6NJ-06 | Z3/8"X18 | 9/16"X18 | 16 | 32.5 | 56.5 | 22 | 22 | |
| 6NJ-08 | Z1/2"X14 | 3/4"X16 | 19.5 | 36.5 | 64 | 24 | 24 | |
| 6NJ-08-10 | Z1/2"X14 | 7/8"X14 | 19.5 | 40 | 69.5 | 30 | 30 | |
| 6NJ-12 | Z3/4"X14 | 1.1/16"X12 | 19.5 | 44.5 | 75 | 36 | 36 | |
| 6NJ-16 | Z1"X11.5 | 1.5/16"X12 | 25.5 | 44.5 | 83 | 41 | 41 | |
| 6NJ-20 | Z1.1/4"X11.5 | 1.5/8"X12 | 26.5 | 45.7 | 87 | 50 | 50 | |
| 6NJ-24 | Z1.1/2"X11.5 | 1.7/8"X12 | 27.5 | 46 | 88.5 | 55 | 55 | |

注：如需带锁母订货，则请在代号后加“LN”，如6NJ-12LN。螺母及衬套需另行订货，管子直径D为公制时，配用螺母及衬套分别选用NB200、NB500。管子直径为英制时，配用螺母及衬套分别选用NB200、NB300。

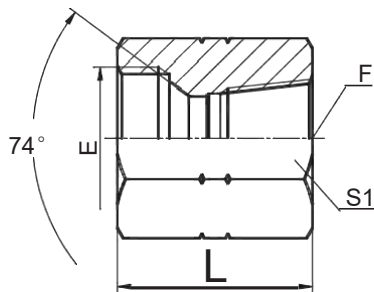

7JN

JIC 74° 内螺纹/ 布锥管内螺纹
JIC FEMALE 74° SEAT/NPT FEMALE

| 代号 PART NO. | 螺 纹 THREAD | | 尺 寸 DIMENSIONS | | | |
|----------------|------------|----------|----------------|----|--|--|
| | E | F | L | S1 | | |
| 7JN-04 | 7/16"X20 | Z1/4"X18 | 31 | 19 | | |
| 7JN-05-04 | 1/2"X20 | Z1/4"X18 | 31 | 19 | | |
| 7JN-06-04 | 9/16"X18 | Z1/4"X18 | 31.5 | 19 | | |
| 7JN-06 | 9/16"X18 | Z3/8"X18 | 31.5 | 22 | | |
| 7JN-08-04 | 3/4"X16 | Z1/4"X18 | 33 | 24 | | |
| 7JN-08 | 3/4"X16 | Z1/2"X14 | 37 | 30 | | |
| 7JN-10-04 | 7/8"X14 | Z1/4"X18 | 35 | 27 | | |
| 7JN-10-08 | 7/8"X14 | Z1/2"X14 | 40 | 30 | | |
| 7JN-12-04 | 1.1/16"X12 | Z1/4"X18 | 36 | 32 | | |
| 7JN-12-08 | 1.1/16"X12 | Z1/2"X14 | 41 | 32 | | |

美制螺纹JIC 74° 锥面扩口接头 JIC 74° Cone Flared Tube Fittings

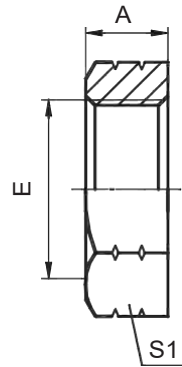

8J

美制JIC螺纹锁母
JIC Lock Nut

| 代号 PART NO. | 螺 纹 THREAD | | | 尺 寸 DIMENSIONS | | | | |
|----------------|------------|--|--|----------------|----|--|--|--|
| | E | | | A | S1 | | | |
| 8J-04 | 7/16"X20 | | | 7 | 17 | | | |
| 8J-05 | 1/2"X20 | | | 7 | 19 | | | |
| 8J-06 | 9/16"X18 | | | 7 | 22 | | | |
| 8J-08 | 3/4"X16 | | | 8 | 24 | | | |
| 8J-10 | 7/8"X14 | | | 9 | 30 | | | |
| 8J-12 | 1.1/16"X12 | | | 10.5 | 36 | | | |
| 8J-14 | 1.3/16"X12 | | | 10.5 | 38 | | | |
| 8J-16 | 1.5/16"X12 | | | 10.5 | 41 | | | |
| 8J-20 | 1.5/8"X12 | | | 10.5 | 50 | | | |
| 8J-24 | 1.7/8"X12 | | | 10.5 | 55 | | | |
| 8J-32 | 2.1/2"X12 | | | 10.5 | 70 | | | |

H

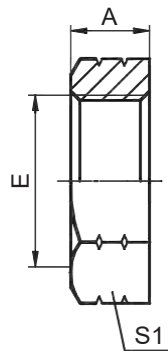

8J-OG

美制SAE O-RING 用锁母
SAE O-RING Lock Nut

| 代号 PART NO. | 螺 纹 THREAD | | | 尺 寸 DIMENSIONS | | | | |
|----------------|------------|--|--|----------------|----|--|--|--|
| | E | | | A | S1 | | | |
| 8J-03OG | 3/8"X24 | | | 7.2 | 14 | | | |
| 8J-05OG | 1/2"X20 | | | 7 | 17 | | | |
| 8J-06OG | 9/16"X18 | | | 7 | 19 | | | |
| 8J-10OG | 7/8"X14 | | | 9 | 27 | | | |
| 8J-12OG | 1.1/16"X12 | | | 10.5 | 32 | | | |
| 8J-14OG | 1.3/16"X12 | | | 10.5 | 36 | | | |

注：其它规格与8J系列相同。

美制螺纹JIC 74° 锥面扩口接头 JIC 74° Cone Flared Tube Fittings

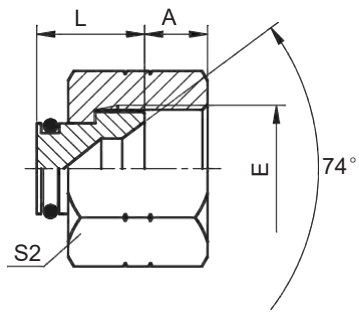

9J

美制JIC内螺纹74° 内锥堵头
JIC FEMALE 74° SEAT PLUG

| 代号 PART NO. | 螺 纹 THREAD | | | 尺 寸 DIMENSIONS | | | | |
|----------------|------------|--|--|----------------|------|----|--|--|
| | E | | | A | L | S2 | | |
| 9J-03 | 3/8"X24 | | | 8 | 10.5 | 14 | | |
| 9J-04 | 7/16"X20 | | | 9 | 10.5 | 15 | | |
| 9J-05 | 1/2"X20 | | | 9.5 | 11 | 17 | | |
| 9J-06 | 9/16"X18 | | | 10.5 | 11 | 19 | | |
| 9J-08 | 3/4"X16 | | | 11 | 13 | 24 | | |
| 9J-10 | 7/8"X14 | | | 13 | 13.5 | 27 | | |
| 9J-12 | 1.1/16"X12 | | | 15 | 15 | 32 | | |
| 9J-14 | 1.3/16"X12 | | | 15 | 15 | 36 | | |
| 9J-16 | 1.5/16"X12 | | | 16 | 15.5 | 41 | | |
| 9J-20 | 1.5/8"X12 | | | 17 | 18.5 | 50 | | |
| 9J-24 | 1.7/8"X12 | | | 20 | 19 | 55 | | |
| 9J-32 | 2.1/2"X12 | | | 23.5 | 20.5 | 75 | | |

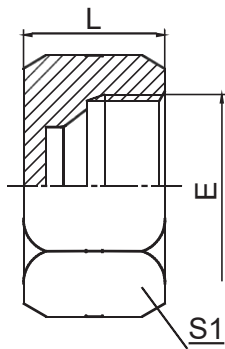

9J-CAP

JIC 74° 内螺纹堵头
JIC 74° FEMALE PLUG

| 代号 PART NO. | 螺 纹 THREAD | | | 尺 寸 DIMENSIONS | | | | |
|----------------|------------|--|--|----------------|----|--|--|--|
| | E | | | L | S1 | | | |
| 9J-04CAP | 7/16"X20 | | | 15.1 | 15 | | | |
| 9J-10CAP | 7/8"X14 | | | 21.4 | 27 | | | |
| 9J-05CAP | 1/2"X20 | | | 15.5 | 17 | | | |
| 9J-06CAP | 9/16"X18 | | | 15.9 | 19 | | | |
| 9J-08CAP | 3/4"X16 | | | 19 | 24 | | | |
| 9J-12CAP | 1.1/16"X12 | | | 23 | 32 | | | |
| 9J-20CAP | 1.5/8"X12 | | | 27 | 50 | | | |
| 9J-24CAP | 1.7/8"X12 | | | 30.2 | 60 | | | |
| 9J-32CAP | 2.1/2"X12 | | | 36.5 | 75 | | | |
| 9J-16CAP | 1.5/16"X12 | | | 25.8 | 41 | | | |

美制螺纹JIC 74° 锥面扩口接头 JIC 74° Cone Flared Tube Fittings

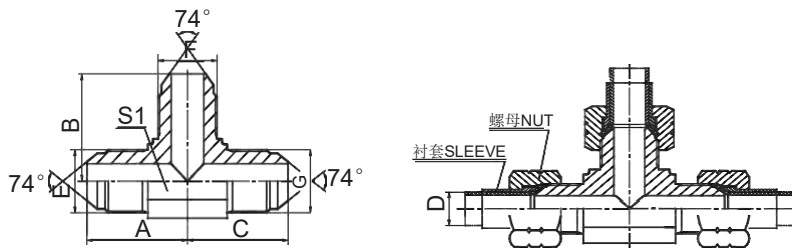

AJ

美制JIC外螺纹74° 外锥
JIC MALE 74° CONE

| 代号 PART NO. | 螺 纹 THREAD | | | 尺 寸 DIMENSIONS | | | | |
|----------------|------------|------------|------------|----------------|------|------|----|--|
| | E | F | G | A | B | C | S1 | |
| AJ-02 | 5/16"X24 | 5/16"X24 | 5/16"X24 | 21 | 21 | 21 | 11 | |
| AJ-03 | 3/8"X24 | 3/8"X24 | 3/8"X24 | 22 | 22 | 22 | 11 | |
| AJ-04 | 7/16"X20 | 7/16"X20 | 7/16"X20 | 24.5 | 24.5 | 24.5 | 11 | |
| AJ-04-06-04 | 7/16"X20 | 9/16"X18 | 7/16"X20 | 26.6 | 26.9 | 26.6 | 14 | |
| AJ-05-04-05 | 1/2"X20 | 7/16"X20 | 1/2"X20 | 26 | 26.6 | 26 | 14 | |
| AJ-05 | 1/2"X20 | 1/2"X20 | 1/2"X20 | 26 | 26 | 26 | 14 | |
| AJ-06-04-06 | 9/16"X18 | 7/16"X20 | 9/16"X18 | 26.9 | 26.6 | 26.9 | 14 | |
| AJ-06 | 9/16"X18 | 9/16"X18 | 9/16"X18 | 26.9 | 26.9 | 26.9 | 14 | |
| AJ-06-08-06 | 9/16"X18 | 3/4"X16 | 9/16"X18 | 30 | 32 | 30 | 19 | |
| AJ-08 | 3/4"X16 | 3/4"X16 | 3/4"X16 | 32 | 32 | 32 | 19 | |
| AJ-08-06-06 | 3/4"X16 | 9/16"X18 | 9/16"X18 | 32 | 30 | 30 | 19 | |
| AJ-08-06-08 | 3/4"X16 | 9/16"X18 | 3/4"X16 | 32 | 30 | 32 | 19 | |
| AJ-08-10-08 | 3/4"X16 | 7/8"X14 | 3/4"X16 | 34.8 | 37.8 | 34.8 | 22 | |
| AJ-08-12-08 | 3/4"X16 | 1.1/16"X12 | 3/4"X16 | 37.9 | 44.2 | 37.9 | 27 | |
| AJ-10 | 7/8"X14 | 7/8"X14 | 7/8"X14 | 37.8 | 37.8 | 37.8 | 22 | |
| AJ-10-08-08 | 7/8"X14 | 3/4"X16 | 3/4"X16 | 37.8 | 34.8 | 34.8 | 22 | |
| AJ-10-08-10 | 7/8"X14 | 3/4"X16 | 7/8"X14 | 37.8 | 34.8 | 37.8 | 22 | |
| AJ-10-12-10 | 7/8"X14 | 1.1/16"X12 | 7/8"X14 | 41 | 44.2 | 41 | 27 | |
| AJ-12 | 1.1/16"X12 | 1.1/16"X12 | 1.1/16"X12 | 44.2 | 44.2 | 44.2 | 27 | |
| AJ-12-08-12 | 1.1/16"X12 | 3/4"X16 | 1.1/16"X12 | 44.2 | 37.9 | 44.2 | 27 | |
| AJ-12-10-12 | 1.1/16"X12 | 7/8"X14 | 1.1/16"X12 | 44.2 | 41 | 44.2 | 27 | |
| AJ-12-16-12 | 1.1/16"X12 | 1.5/16"X12 | 1.1/16"X12 | 48 | 49 | 48 | 33 | |
| AJ-14 | 1.3/16"X12 | 1.3/16"X12 | 1.3/16"X12 | 47.5 | 47.5 | 47.5 | 30 | |
| AJ-16 | 1.5/16"X12 | 1.5/16"X12 | 1.5/16"X12 | 49 | 49 | 49 | 33 | |
| AJ-16-12-16 | 1.5/16"X12 | 1.1/16"X12 | 1.5/16"X12 | 49 | 48 | 49 | 33 | |
| AJ-20 | 1.5/8"X12 | 1.5/8"X12 | 1.5/8"X12 | 56.5 | 56.5 | 56.5 | 41 | |
| AJ-20-16-20 | 1.5/8"X12 | 1.5/16"X12 | 1.5/8"X12 | 56.5 | 54 | 56.5 | 41 | |
| AJ-24 | 1.7/8"X12 | 1.7/8"X12 | 1.7/8"X12 | 63 | 63 | 63 | 48 | |
| AJ-32 | 2.1/2"X12 | 2.1/2"X12 | 2.1/2"X12 | 78 | 78 | 78 | 63 | |

注：螺母及衬套需另行订货。管子直径D为公制时，配用螺母及衬套分别选用NB200、NB500。管子直径为英制时，配用螺母及衬套分别选用NB200、NB300。 Nut and sleeve should be ordered separately. The nut NB200 and sleeve NB500 is suitable for metric tube, the nut NB200 and sleeve NB300 is suitable for inch tube.

H

美制螺纹JIC 74° 锥面扩口接头 JIC 74° Cone Flared Tube Fittings

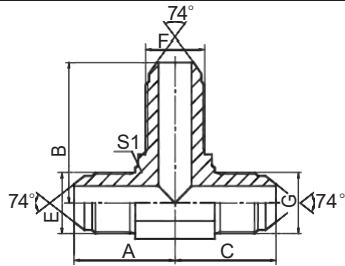

AJ6JJ

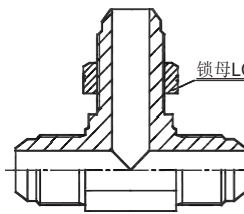

AJ6JJ-LN

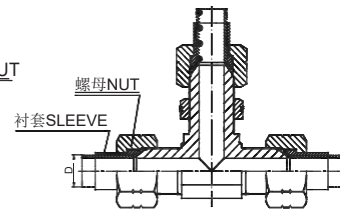

JIC外螺纹74° 外锥
JIC MALE 74° CONE

| 代号 PART NO. | 螺纹 THREAD | | | 尺寸 DIMENSIONS | | | | | |
|----------------|------------|------------|------------|---------------|------|------|----|----|--|
| | E | F | G | A | B | C | S1 | S2 | |
| AJ6JJ-04 | 7/16"X20 | 7/16"X20 | 7/16"X20 | 24.5 | 40.4 | 24.5 | 11 | 17 | |
| AJ6JJ-04-06-04 | 7/16"X20 | 9/16"X18 | 7/16"X20 | 26.4 | 46 | 26.4 | 14 | 22 | |
| AJ6JJ-05 | 1/2"X20 | 1/2"X20 | 1/2"X20 | 26.6 | 43.7 | 26.6 | 14 | 19 | |
| AJ6JJ-06 | 9/16"X18 | 9/16"X18 | 9/16"X18 | 26.9 | 46 | 26.9 | 14 | 22 | |
| AJ6JJ-08 | 3/4"X16 | 3/4"X16 | 3/4"X16 | 32 | 53.5 | 32 | 19 | 24 | |
| AJ6JJ-10 | 7/8"X14 | 7/8"X14 | 7/8"X14 | 37.8 | 60.7 | 37.8 | 22 | 30 | |
| AJ6JJ-12 | 1.1/16"X12 | 1.1/16"X12 | 1.1/16"X12 | 44.2 | 67.8 | 44.2 | 27 | 36 | |
| AJ6JJ-14 | 1.3/16"X12 | 1.3/16"X12 | 1.3/16"X12 | 48.5 | 71 | 48.5 | 33 | 38 | |
| AJ6JJ-16 | 1.5/16"X12 | 1.5/16"X12 | 1.5/16"X12 | 49 | 71 | 49 | 33 | 41 | |
| AJ6JJ-20 | 1.5/8"X12 | 1.5/8"X12 | 1.5/8"X12 | 55.3 | 79.2 | 55.3 | 41 | 50 | |
| AJ6JJ-24 | 1.7/8"X12 | 1.7/8"X12 | 1.7/8"X12 | 63.5 | 86.9 | 63.5 | 48 | 55 | |

注：如需带锁母订货，则请在代号后加“LN”，如AJ6JJ-12LN。螺母及衬套需另行订货，管子直径D为公制时，配用螺母及衬套分别选用NB200、NB500。管子直径为英制时，配用螺母及衬套分别选用NB200、NB300。

Note: In case if you are interested to order the adapter with lock nut, please insert suffix "LN" after our part no, for example AJ6JJ-12LN. Nut and sleeve should be ordered separately. The nut NB200 and sleeve NB500 is suitable for metric tube, the nut NB200 and sleeve NB300 is suitable for inch tube.

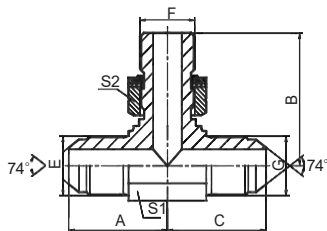

AJGJ-OG

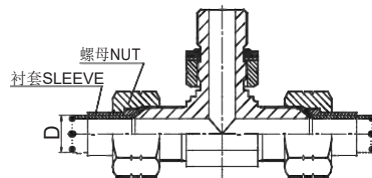

JIC外螺纹 /
英管外螺纹O形圈 / JIC外螺纹
JIC MALE /
BSP MALE O-RING / JIC MALE

| 代号 PART NO. | 螺纹 THREAD | | | O形圈 O-RING | 尺寸 DIMENSIONS | | | | |
|-----------------|------------|----------|------------|------------|---------------|------|------|----|----|
| | E | F | G | F端 | A | B | C | S1 | S2 |
| AJGJ-04OG | 7/16"X20 | G1/4"X19 | 7/16"X20 | 10.77X2.62 | 26.6 | 31.8 | 26.6 | 14 | 19 |
| AJGJ-04-02-04OG | 7/16"X20 | G1/8"X28 | 7/16"X20 | 10.77X2.62 | 24.5 | 26.2 | 24.5 | 11 | 19 |
| AJGJ-05-02-05OG | 1/2"X20 | G1/8"X28 | 1/2"X20 | 10.77X2.62 | 26.6 | 29 | 26.6 | 14 | 19 |
| AJGJ-05-04-05OG | 1/2"X20 | G1/4"X19 | 1/2"X20 | 10.77X2.62 | 26.6 | 31.8 | 26.6 | 14 | 19 |
| AJGJ-06-04-06OG | 9/16"X18 | G1/4"X19 | 9/16"X18 | 10.77X2.62 | 37 | 31 | 27 | 14 | 19 |
| AJGJ-06OG | 9/16"X18 | G3/8"X19 | 9/16"X18 | 13.94X2.62 | 28.5 | 36.8 | 28.5 | 16 | 22 |
| AJGJ-08-06-08OG | 3/4"X16 | G3/8"X19 | 3/4"X16 | 13.94X2.62 | 33 | 37 | 33 | 19 | 22 |
| AJGJ-08OG | 3/4"X16 | G1/2"X14 | 3/4"X16 | 17.12X2.62 | 35 | 43.2 | 35 | 22 | 27 |
| AJGJ-10-08-10OG | 7/8"X14 | G1/2"X14 | 7/8"X14 | 17.12X2.62 | 37.8 | 43.5 | 37.8 | 22 | 27 |
| AJGJ-12OG | 1.1/16"X12 | G3/4"X14 | 1.1/16"X12 | 23.47X2.62 | 44.2 | 51 | 44.2 | 27 | 32 |
| AJGJ-16OG | 1.5/16"X12 | G1"X11 | 1.5/16"X12 | 29.74X3.53 | 48.8 | 53 | 48.8 | 33 | 41 |

注：螺母及衬套需另行订货。管子直径D为公制时，配用螺母及衬套分别选用NB200、NB500。管子直径为英制时，配用螺母及衬套分别选用NB200、NB300。Nut and sleeve should be ordered separately. The nut NB200 and sleeve NB500 is suitable for metric tube, the nut NB200 and sleeve NB300 is suitable for inch tube.

美制螺纹JIC 74° 锥面扩口接头 JIC 74° Cone Flared Tube Fittings

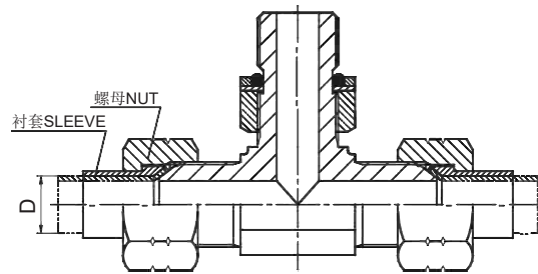
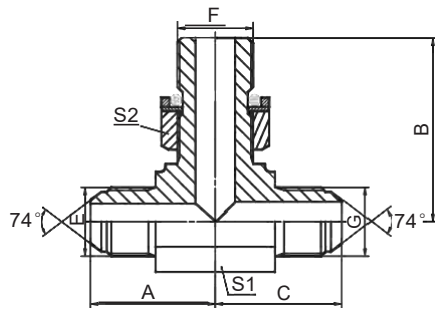

AJHJ-OG

JIC外螺纹 / 公制外螺纹O形圈 / JIC外螺纹
JIC MALE / METRIC MAIL O-RING / JIC MALE

| 代号 PART NO. | 螺 纹 THREAD | | | O形圈 O-RING | 尺 寸 DIMENSIONS | | | | | |
|-----------------|------------|---------|------------|------------|----------------|------|------|----|----|--|
| | E | F | G | F端 | A | B | C | S1 | S2 | |
| AJHJ-04-10-04OG | 7/16"X20 | M10X1 | 7/16"X20 | 8.1X1.6 | 24.5 | 26.5 | 24.5 | 11 | 14 | |
| AJHJ-04-12-04OG | 7/16"X20 | M12X1.5 | 7/16"X20 | 9.3X2.4 | 26.6 | 32 | 26.6 | 14 | 17 | |
| AJHJ-05-10-05OG | 1/2"X20 | M10X1 | 1/2"X20 | 8.1X1.6 | 26.6 | 28.8 | 26.6 | 14 | 14 | |
| AJHJ-05-12-05OG | 1/2"X20 | M12X1.5 | 1/2"X20 | 9.3X2.4 | 26.6 | 32 | 26.6 | 14 | 17 | |
| AJHJ-05-14-05OG | 1/2"X20 | M14X1.5 | 1/2"X20 | 11.3X2.4 | 26.6 | 32 | 26.6 | 14 | 19 | |
| AJHJ-06-14-06OG | 9/16"X18 | M14X1.5 | 9/16"X18 | 11.3X2.4 | 26.9 | 32 | 26.9 | 14 | 19 | |
| AJHJ-06-16-06OG | 9/16"X18 | M16X1.5 | 9/16"X18 | 13.3X2.4 | 28.5 | 34.8 | 28.5 | 16 | 22 | |
| AJHJ-08-16-08OG | 3/4"X16 | M16X1.5 | 3/4"X16 | 13.3X2.4 | 32 | 36 | 32 | 19 | 22 | |
| AJHJ-08-18-08OG | 3/4"X16 | M18X1.5 | 3/4"X16 | 15.3X2.4 | 32 | 37 | 32 | 19 | 24 | |
| AJHJ-10-18-10OG | 7/8"X14 | M18X1.5 | 7/8"X14 | 15.3X2.4 | 37.8 | 39.5 | 37.8 | 22 | 24 | |
| AJHJ-10-22-10OG | 7/8"X14 | M22X1.5 | 7/8"X14 | 19.3X2.4 | 37.8 | 40.2 | 37.8 | 22 | 27 | |
| AJHJ-12-22-12OG | 1.1/16"X12 | M22X1.5 | 1.1/16"X12 | 19.3X2.4 | 44.2 | 43.5 | 44.2 | 27 | 27 | |
| AJHJ-12-27-12OG | 1.1/16"X12 | M27X2 | 1.1/16"X12 | 23.5X3 | 44.2 | 48.5 | 44.2 | 27 | 32 | |
| AJHJ-16-27-16OG | 1.5/16"X12 | M27X2 | 1.5/16"X12 | 23.5X3 | 49 | 52 | 49 | 33 | 32 | |
| AJHJ-16-33-16OG | 1.5/16"X12 | M33X2 | 1.5/16"X12 | 29.2X3 | 49 | 52.5 | 49 | 33 | 41 | |
| AJHJ-20-42-20OG | 1.5/8"X12 | M42X2 | 1.5/8"X12 | 38.5X3 | 55.5 | 57.2 | 55.5 | 41 | 50 | |
| AJHJ-24-48-24OG | 1.7/8"X12 | M48X2 | 1.7/8"X12 | 44.5X3 | 62.5 | 62.7 | 62.5 | 48 | 55 | |

注：螺母及衬套需另行订货。管子直径D为公制时，配用螺母及衬套分别选用NB200、NB500。管子直径为英制时，配用螺母及衬套分别选用NB200、NB300。 Nut and sleeve should be ordered separately. The nut NB200 and sleeve NB500 is suitable for metric tube, the nut NB200 and sleeve NB300 is suitable for inch tube.

H

美制螺纹JIC 74° 锥面扩口接头 JIC 74° Cone Flared Tube Fittings

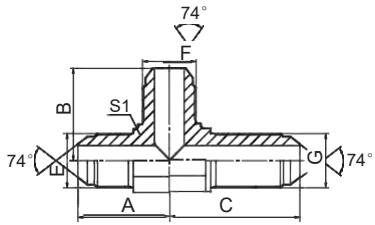

AJJ6J

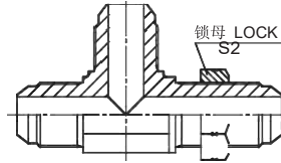

AJJ6J-LN

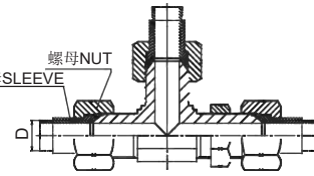

JIC外螺纹74° 外锥
JIC MALE 74° CONE

| 代号 PART NO. | 螺 纹 THREAD | | | 尺 寸 DIMENSIONS | | | | | |
|----------------|------------|------------|------------|----------------|------|------|----|----|--|
| | E | F | G | A | B | C | S1 | S2 | |
| AJJ6J-04 | 7/16"X20 | 7/16"X20 | 7/16"X20 | 24.5 | 24.5 | 40.4 | 11 | 17 | |
| AJJ6J-05 | 1/2"X20 | 1/2"X20 | 1/2"X20 | 26.6 | 26.6 | 43.7 | 14 | 19 | |
| AJJ6J-06 | 9/16"X18 | 9/16"X18 | 9/16"X18 | 26.9 | 26.9 | 46 | 14 | 22 | |
| AJJ6J-08 | 3/4"X16 | 3/4"X16 | 3/4"X16 | 32 | 32 | 53.5 | 19 | 24 | |
| AJJ6J-10 | 7/8"X14 | 7/8"X14 | 7/8"X14 | 37.8 | 37.8 | 60.7 | 22 | 30 | |
| AJJ6J-12 | 1.1/16"X12 | 1.1/16"X12 | 1.1/16"X12 | 44.2 | 44.2 | 67.8 | 27 | 36 | |
| AJJ6J-16 | 1.5/16"X12 | 1.5/16"X12 | 1.5/16"X12 | 49 | 49 | 71 | 33 | 41 | |
| AJJ6J-20 | 1.5/8"X12 | 1.5/8"X12 | 1.5/8"X12 | 55.3 | 55.3 | 79.2 | 41 | 50 | |
| AJJ6J-24 | 1.7/8"X12 | 1.7/8"X12 | 1.7/8"X12 | 63.5 | 63.5 | 86.9 | 48 | 55 | |

注：如需带锁母订货，则请在代号后加“LN”，如AJJ6J-12LN。螺母及衬套需另行订货，管子直径D为公制时，配用螺母及衬套分别选用NB200、NB500。管子直径为英制时，配用螺母及衬套分别选用NB200、NB300。

Note: In case if you are interested to order the adapter with lock nut, please insert suffix "LN" after our part no., for example AJJ6J-12LN. Nut and sleeve should be ordered separately, The nut NB200 and sleeve NB500 is suitable for metric tube, the nut NB200 and sleeve NB300 is suitable for inch tube.

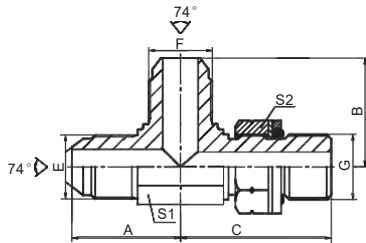

AJJG-OG

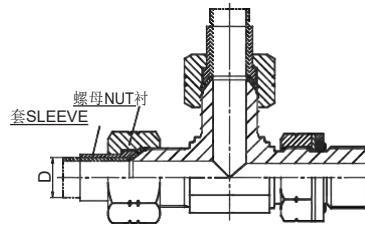

JIC外螺纹 / JIC外螺纹 / 英管外螺纹O形圈
JIC MALE / JIC MALE / BSP MALE O-RING

| 代号 PART NO. | 螺 纹 THREAD | | | O形圈 O-RING | 尺 寸 DIMENSIONS | | | | | |
|-----------------|------------|------------|----------|------------|----------------|------|------|----|----|--|
| | E | F | G | G端 | A | B | C | S1 | S2 | |
| AJJG-04OG | 7/16"X20 | 7/16"X20 | G1/4"X19 | 10.77X2.62 | 26.6 | 26.5 | 31.9 | 14 | 19 | |
| AJJG-05-05-04OG | 1/2"X20 | 1/2"X20 | G1/4"X19 | 10.77X2.62 | 26.6 | 26.6 | 31.3 | 14 | 19 | |
| AJJG-05-06-04OG | 1/2"X20 | 9/16"X18 | G1/4"X19 | 10.77X2.62 | 26.6 | 26.9 | 31.3 | 14 | 19 | |
| AJJG-06OG | 9/16"X18 | 9/16"X18 | G3/8"X19 | 13.94X2.62 | 28.5 | 28.5 | 36.8 | 16 | 22 | |
| AJJG-06-06-04OG | 9/16"X18 | 9/16"X18 | G1/4"X19 | 10.77X2.62 | 26.9 | 26.9 | 31.3 | 14 | 19 | |
| AJJG-08-08-06OG | 3/4"X16 | 3/4"X16 | G3/8"X19 | 13.94X2.62 | 32 | 32 | 36.8 | 19 | 22 | |
| AJJG-08OG | 3/4"X16 | 3/4"X16 | G1/2"X14 | 17.12X2.62 | 35 | 35 | 43.2 | 22 | 27 | |
| AJJG-10-10-08OG | 7/8"X14 | 7/8"X14 | G1/2"X14 | 17.12X2.62 | 37.8 | 37.8 | 44 | 22 | 27 | |
| AJJG-12OG | 1.1/16"X12 | 1.1/16"X12 | G3/4"X14 | 23.47X2.62 | 44 | 44 | 49.5 | 27 | 32 | |
| AJJG-16OG | 1.5/16"X12 | 1.5/16"X12 | G1"X11 | 29.74X3.53 | 48.8 | 48.8 | 53 | 33 | 41 | |

注：螺母及衬套需另行订货。管子直径D为公制时，配用螺母及衬套分别选用NB200、NB500。管子直径为英制时，配用螺母及衬套分别选用NB200、NB300。 Nut and sleeve should be ordered separately. The nut NB200 and sleeve NB500 is suitable for metric tube, the nut NB200 and sleeve NB300 is suitable for inch tube.

美制螺纹JIC 74° 锥面扩口接头 JIC 74° Cone Flared Tube Fittings

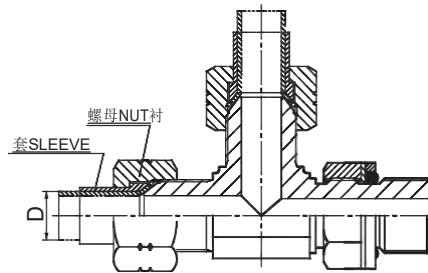
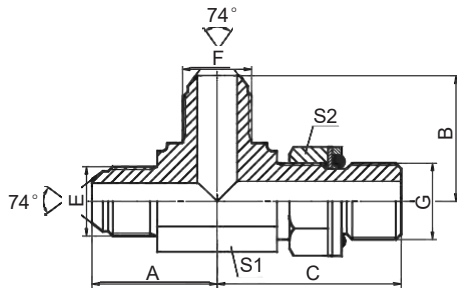

AJHH-OG

JIC外螺纹 / JIC外螺纹 / 公制外螺纹O形圈
JIC MALE / JIC MALE / METRIC MALE O-RING

| 代号 PART NO. | 螺 纹 THREAD | | | O形圈 O-RING | | 尺 寸 DIMENSIONS | | | | |
|-----------------|------------|------------|---------|------------|----------|----------------|------|------|----|----|
| | E | F | G | | G端 | A | B | C | S1 | S2 |
| AJHH-04-04-10OG | 7/16"X20 | 7/16"X20 | M10X1 | | 8.1X1.6 | 24.5 | 24.5 | 26.5 | 11 | 14 |
| AJHH-04-04-12OG | 7/16"X20 | 7/16"X20 | M12X1.5 | | 9.3X2.4 | 26.6 | 26.6 | 32 | 14 | 17 |
| AJHH-05-05-10OG | 1/2"X20 | 1/2"X20 | M10X1 | | 8.1X1.6 | 26.6 | 26.6 | 28.8 | 14 | 14 |
| AJHH-05-05-12OG | 1/2"X20 | 1/2"X20 | M12X1.5 | | 9.3X2.4 | 26.5 | 26.5 | 32 | 14 | 17 |
| AJHH-05-05-14OG | 1/2"X20 | 1/2"X20 | M14X1.5 | | 11.3X2.4 | 26.6 | 26.6 | 32 | 14 | 19 |
| AJHH-06-06-14OG | 9/16"X18 | 9/16"X18 | M14X1.5 | | 11.3X2.4 | 26.9 | 26.9 | 32 | 14 | 19 |
| AJHH-06-06-16OG | 9/16"X18 | 9/16"X18 | M16X1.5 | | 13.3X2.4 | 28.5 | 28.5 | 34.8 | 16 | 22 |
| AJHH-08-08-16OG | 3/4"X16 | 3/4"X16 | M16X1.5 | | 13.3X2.4 | 32 | 32 | 36 | 19 | 22 |
| AJHH-08-08-18OG | 3/4"X16 | 3/4"X16 | M18X1.5 | | 15.3X2.4 | 32 | 32 | 37 | 19 | 24 |
| AJHH-10-10-18OG | 7/8"X14 | 7/8"X14 | M18X1.5 | | 15.3X2.4 | 37.8 | 37.8 | 39.5 | 22 | 24 |
| AJHH-10-10-22OG | 7/8"X14 | 7/8"X14 | M22X1.5 | | 19.3X2.4 | 37.8 | 37.8 | 40.2 | 22 | 27 |
| AJHH-12-12-22OG | 1.1/16"X12 | 1.1/16"X12 | M22X1.5 | | 19.3X2.4 | 44.2 | 44.2 | 43.5 | 27 | 27 |
| AJHH-12-12-27OG | 1.1/16"X12 | 1.1/16"X12 | M27X2 | | 23.5X3 | 44.2 | 44.2 | 48.5 | 27 | 32 |
| AJHH-16-16-27OG | 1.5/16"X12 | 1.5/16"X12 | M27X2 | | 23.5X3 | 49 | 49 | 52 | 33 | 32 |
| AJHH-16-16-33OG | 1.5/16"X12 | 1.5/16"X12 | M33X2 | | 29.2X3 | 49 | 49 | 52.5 | 33 | 41 |
| AJHH-20-20-42OG | 1.5/8"X12 | 1.5/8"X12 | M42X2 | | 38.5X3 | 55.5 | 55.5 | 57.2 | 41 | 50 |
| AJHH-24-24-48OG | 1.7/8"X12 | 1.7/8"X12 | M48X2 | | 44.5X3 | 62.5 | 62.5 | 62.7 | 48 | 55 |

注：螺母及衬套需另行订货。管子直径D为公制时，配用螺母及衬套分别选用NB200、NB500。管子直径为英制时，配用螺母及衬套分别选用NB200、NB300。 Nut and sleeve should be ordered separately. The nut NB200 and sleeve NB500 is suitable for metric tube, the nut NB200 and sleeve NB300 is suitable for inch tube.

H

美制螺纹JIC 74° 锥面扩口接头 JIC 74° Cone Flared Tube Fittings

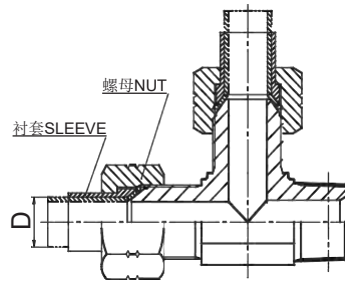
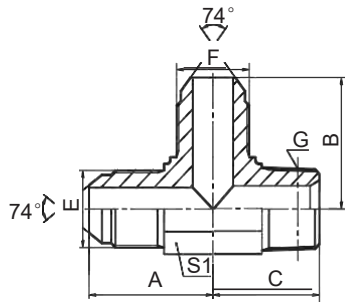

AJJN

JIC外螺纹 / JIC外螺纹 / 布锥管外螺纹
JIC MALE / JIC MALE / NPT MALE

| 代号 PART NO. | 螺 纹 THREAD | | | 尺 寸 DIMENSIONS | | | | | |
|----------------|------------|------------|--------------|----------------|--|------|------|------|----|
| | E | F | G | | | A | B | C | S1 |
| AJJN-04 | 7/16"X20 | 7/16"X20 | Z1/4"X18 | | | 26.6 | 26.6 | 25.5 | 14 |
| AJJN-04-04-02 | 7/16"X20 | 7/16"X20 | Z1/8"X27 | | | 24.5 | 24.5 | 21 | 11 |
| AJJN-05-05-02 | 1/2"X20 | 1/2"X20 | Z1/8"X27 | | | 26.5 | 26.5 | 23.5 | 14 |
| AJJN-05-05-04 | 1/2"X20 | 1/2"X20 | Z1/4"X18 | | | 26.5 | 26.5 | 25.5 | 14 |
| AJJN-06 | 9/16"X18 | 9/16"X18 | Z3/8"X18 | | | 30 | 30 | 31 | 19 |
| AJJN-06-06-04 | 9/16"X18 | 9/16"X18 | Z1/4"X18 | | | 26.9 | 26.9 | 25.5 | 14 |
| AJJN-06-06-08 | 9/16"X18 | 9/16"X18 | Z1/2"X14 | | | 32 | 32 | 36.7 | 22 |
| AJJN-08 | 3/4"X16 | 3/4"X16 | Z1/2"X14 | | | 34.8 | 34.8 | 36.7 | 22 |
| AJJN-08-08-06 | 3/4"X16 | 3/4"X16 | Z3/8"X18 | | | 32 | 32 | 31 | 19 |
| AJJN-10-10-08 | 7/8"X14 | 7/8"X14 | Z1/2"X14 | | | 37.8 | 37.8 | 36.7 | 22 |
| AJJN-10-10-12 | 7/8"X14 | 7/8"X14 | Z3/4"X14 | | | 41 | 41 | 44 | 27 |
| AJJN-12 | 1.1/16"X12 | 1.1/16"X12 | Z3/4"X14 | | | 44.2 | 44.2 | 44 | 27 |
| AJJN-16 | 1.5/16"X12 | 1.5/16"X12 | Z1"X11.5 | | | 49 | 49 | 50 | 33 |
| AJJN-20 | 1.5/8"X12 | 1.5/8"X12 | Z1.1/4"X11.5 | | | 55.5 | 55.5 | 54.5 | 41 |
| AJJN-24 | 1.7/8"X12 | 1.7/8"X12 | Z1.1/2"X11.5 | | | 62.5 | 62.5 | 60 | 48 |

注：螺母及衬套需另行订货。管子直径D为公制时，配用螺母及衬套分别选用NB200、NB500。管子直径为英制时，配用螺母及衬套分别选用NB200、NB300。 Nut and sleeve should be ordered separately. The nut NB200 and sleeve NB500 is suitable for metric tube, the nut NB200 and sleeve NB300 is suitable for inch tube.

美制螺纹JIC 74° 锥面扩口接头 JIC 74° Cone Flared Tube Fittings

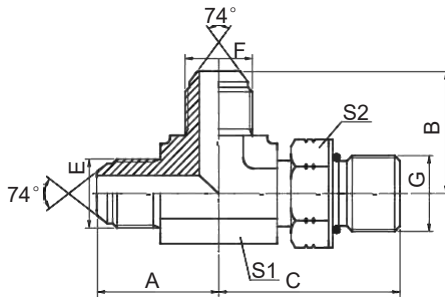

AJJO-OG

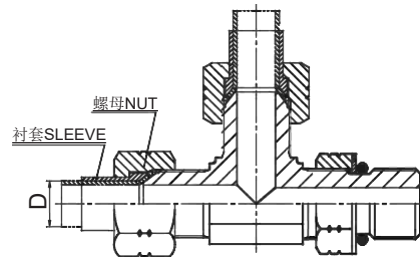

JIC外螺纹 / JIC
外螺纹 / SAE外螺纹O形圈
JIC MALE / JIC
MALE / SAE O-RING BOSS

| 代号 PART NO. | 螺 纹 THREAD | | | O形圈 O-RING | G端 | 尺 寸 DIMENSIONS | | | | |
|-----------------|------------|------------|------------|---------------|------------|----------------|------|------|----|----|
| | E | F | G | | | A | B | C | S1 | S2 |
| AJJO-02OG | 5/16"X24 | 5/16"X24 | 5/16"X24 | | 6.07X1.63 | 23 | 21 | 21 | 11 | 12 |
| AJJO-03OG | 3/8"X24 | 3/8"X24 | 3/8"X24 | | 7.65X1.63 | 23 | 22 | 22 | 11 | 14 |
| AJJO-04OG | 7/16"X20 | 7/16"X20 | 7/16"X20 | | 8.92X1.83 | 24.5 | 24.5 | 27.2 | 11 | 17 |
| AJJO-04-04-06OG | 7/16"X20 | 7/16"X20 | 9/16"X18 | | 11.89X1.98 | 26.6 | 26.6 | 31.8 | 14 | 19 |
| AJJO-05OG | 1/2"X20 | 1/2"X20 | 1/2"X20 | | 10.52X1.83 | 26.6 | 26.6 | 29 | 14 | 17 |
| AJJO-05-05-04OG | 1/2"X20 | 1/2"X20 | 7/16"X20 | | 8.92X1.83 | 26.6 | 26.6 | 30 | 14 | 17 |
| AJJO-06OG | 9/16"X18 | 9/16"X18 | 9/16"X18 | | 11.89X1.98 | 26.9 | 26.9 | 31.8 | 14 | 19 |
| AJJO-06-06-04OG | 9/16"X18 | 9/16"X18 | 7/16"X20 | | 8.92X1.83 | 26.9 | 26.9 | 30 | 14 | 17 |
| AJJO-06-06-05OG | 9/16"X18 | 9/16"X18 | 1/2"X20 | | 10.52X1.83 | 26.9 | 26.9 | 30 | 14 | 17 |
| AJJO-06-06-08OG | 9/16"X18 | 9/16"X18 | 3/4"X16 | | 16.36X2.21 | 30 | 30 | 37.5 | 19 | 24 |
| AJJO-08OG | 3/4"X16 | 3/4"X16 | 3/4"X16 | | 16.36X2.21 | 33 | 33 | 36.8 | 19 | 24 |
| AJJO-08-08-06OG | 3/4"X16 | 3/4"X16 | 9/16"X18 | | 11.89X1.98 | 32 | 32 | 33.5 | 19 | 19 |
| AJJO-08-08-10OG | 3/4"X16 | 3/4"X16 | 7/8"X14 | | 19.18X2.46 | 34.8 | 34.8 | 44 | 22 | 27 |
| AJJO-10OG | 7/8"X14 | 7/8"X14 | 7/8"X14 | | 19.18X2.46 | 37.8 | 37.8 | 44 | 22 | 27 |
| AJJO-10-10-08OG | 7/8"X14 | 7/8"X14 | 3/4"X16 | | 16.36X2.21 | 37.8 | 37.8 | 39.5 | 22 | 24 |
| AJJO-12OG | 1.1/16"X12 | 1.1/16"X12 | 1.1/16"X12 | | 23.47X2.95 | 44.2 | 44.2 | 51 | 27 | 32 |
| AJJO-12-12-08OG | 1.1/16"X12 | 1.1/16"X12 | 3/4"X16 | | 16.36X2.21 | 44.2 | 44.2 | 43 | 27 | 24 |
| AJJO-12-12-10OG | 1.1/16"X12 | 1.1/16"X12 | 7/8"X14 | | 19.18X2.46 | 44.2 | 44.2 | 49 | 27 | 27 |
| AJJO-14OG | 1.3/16"X12 | 1.3/16"X12 | 1.3/16"X12 | | 26.62X2.95 | 47.5 | 47.5 | 53 | 30 | 36 |
| AJJO-16OG | 1.5/16"X12 | 1.5/16"X12 | 1.5/16"X12 | | 29.74X2.95 | 48.8 | 48.8 | 54.5 | 33 | 41 |
| AJJO-16-16-12OG | 1.5/16"X12 | 1.5/16"X12 | 1.1/16"X12 | | 23.47X2.95 | 48.8 | 48.8 | 53.5 | 33 | 32 |
| AJJO-20OG | 1.5/8"X12 | 1.5/8"X12 | 1.5/8"X12 | | 37.46X3.00 | 55.3 | 55.3 | 59 | 41 | 50 |
| AJJO-24OG | 1.7/8"X12 | 1.7/8"X12 | 1.7/8"X12 | | 43.69X3.00 | 62.5 | 62.5 | 63 | 48 | 55 |
| AJJO-32OG | 2.1/2"X12 | 2.1/2"X12 | 2.1/2"X12 | | 59.36X3.00 | 78 | 78 | 79 | 63 | 70 |

注：螺母及衬套需另行订货。管子直径D为公制时，配用螺母及衬套分别选用NB200、NB500。管子直径为英制时，配用螺母及衬套分别选用NB200、NB300。 Nut and sleeve should be ordered separately. The nut NB200 and sleeve NB500 is suitable for metric tube, the nut NB200 and sleeve NB300 is suitable for inch tube.

H

美制螺纹JIC 74° 锥面扩口接头 JIC 74° Cone Flared Tube Fittings

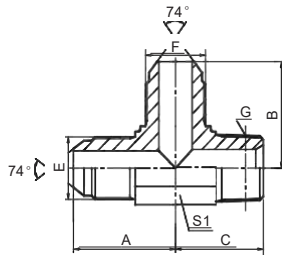

AJJT-SP

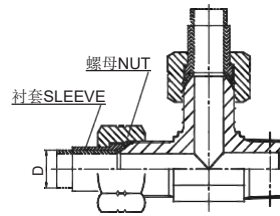

JIC外螺纹 / JIC外螺纹 / 英锥管外螺纹
JIC MALE / JIC MALE / BSPT MALE

| 代号 PART NO. | 螺 纹 THREAD | | | 尺 寸 DIMENSIONS | | | | |
|-----------------|------------|------------|------------|----------------|------|------|----|--|
| | E | F | G | A | B | C | S1 | |
| AJJT-04-04-02SP | 7/16"X20 | 7/16"X20 | R1/8"X28 | 24.5 | 24.5 | 21 | 11 | |
| AJJT-04SP | 7/16"X20 | 7/16"X20 | R1/4"X19 | 26.6 | 26.6 | 25.5 | 14 | |
| AJJT-04-04-06SP | 7/16"X20 | 7/16"X20 | R3/8"X19 | 27.5 | 27.5 | 28 | 16 | |
| AJJT-06-06-04SP | 9/16"X18 | 9/16"X18 | R1/4"X19 | 26.9 | 26.9 | 25.5 | 14 | |
| AJJT-06SP | 9/16"X18 | 9/16"X18 | R3/8"X19 | 28.5 | 28.5 | 28.5 | 16 | |
| AJJT-08-08-06SP | 3/4"X16 | 3/4"X16 | R3/8"X19 | 32 | 32 | 30.5 | 19 | |
| AJJT-08SP | 3/4"X16 | 3/4"X16 | R1/2"X14 | 34.8 | 34.8 | 36 | 22 | |
| AJJT-10-10-08SP | 7/8"X14 | 7/8"X14 | R1/2"X14 | 37.8 | 37.8 | 36 | 22 | |
| AJJT-12SP | 1.1/16"X12 | 1.1/16"X12 | R3/4"X14 | 44.2 | 44.2 | 43.5 | 27 | |
| AJJT-16SP | 1.5/16"X12 | 1.5/16"X12 | R1"X11 | 49 | 49 | 50 | 33 | |
| AJJT-20SP | 1.5/8"X12 | 1.5/8"X12 | R1.1/4"X11 | 55.5 | 55.5 | 56.5 | 41 | |
| AJJT-24SP | 1.7/8"X12 | 1.7/8"X12 | R1.1/2"X11 | 62.5 | 62.5 | 62.5 | 48 | |

注：螺母及衬套需另行订货。管子直径D为公制时，配用螺母及衬套分别选用NB200、NB500。管子直径为英制时，配用螺母及衬套分别选用NB200、NB300。 Nut and sleeve should be ordered separately. The nut NB200 and sleeve NB500 is suitable for metric tube, the nut NB200 and sleeve NB300 is suitable for inch tube.

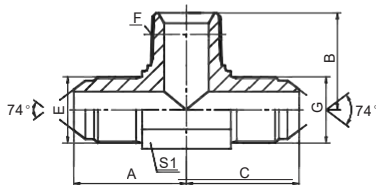

AJNJ

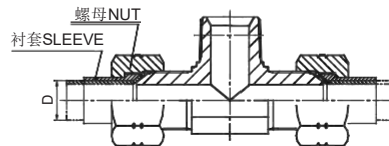

JIC外螺纹 / 布锥管外螺纹 / JIC外螺纹
JIC MALE / NPT MALE / JIC MALE

| 代号 PART NO. | 螺 纹 THREAD | | | 尺 寸 DIMENSIONS | | | | |
|----------------|------------|--------------|------------|----------------|------|------|----|--|
| | E | F | G | A | B | C | S1 | |
| AJNJ-02 | 5/16"X24 | Z1/8"X27 | 5/16"X24 | 21 | 21 | 21 | 11 | |
| AJNJ-03-02-03 | 3/8"X24 | Z1/8"X27 | 3/8"X24 | 22 | 21 | 22 | 11 | |
| AJNJ-04 | 7/16"X20 | Z1/4"X18 | 7/16"X20 | 26.6 | 25.5 | 26.6 | 14 | |
| AJNJ-04-02-04 | 7/16"X20 | Z1/8"X27 | 7/16"X20 | 24.5 | 21 | 24.5 | 11 | |
| AJNJ-05-02-05 | 1/2"X20 | Z1/8"X27 | 1/2"X20 | 26.6 | 23.5 | 26.6 | 14 | |
| AJNJ-05-04-05 | 1/2"X20 | Z1/4"X18 | 1/2"X20 | 26.6 | 25.5 | 26.6 | 14 | |
| AJNJ-06 | 9/16"X18 | Z3/8"X18 | 9/16"X18 | 30 | 31 | 30 | 19 | |
| AJNJ-06-04-06 | 9/16"X18 | Z1/4"X18 | 9/16"X18 | 26.9 | 25.5 | 26.9 | 14 | |
| AJNJ-06-08-06 | 9/16"X18 | Z1/2"X14 | 9/16"X18 | 32 | 36.7 | 32 | 22 | |
| AJNJ-08 | 3/4"X16 | Z1/2"X14 | 3/4"X16 | 34.8 | 37.3 | 34.8 | 22 | |
| AJNJ-08-06-08 | 3/4"X16 | Z3/8"X18 | 3/4"X16 | 32 | 31 | 32 | 19 | |
| AJNJ-10-08-10 | 7/8"X14 | Z1/2"X14 | 7/8"X14 | 37.8 | 36.7 | 37.8 | 22 | |
| AJNJ-12 | 1.1/16"X12 | Z3/4"X14 | 1.1/16"X12 | 44.2 | 44 | 44.2 | 27 | |
| AJNJ-16 | 1.5/16"X12 | Z1"X11.5 | 1.5/16"X12 | 49 | 50 | 49 | 33 | |
| AJNJ-20 | 1.5/8"X12 | Z1.1/4"X11.5 | 1.5/8"X12 | 55.5 | 54.5 | 55.5 | 41 | |
| AJNJ-24 | 1.7/8"X12 | Z1.1/2"X11.5 | 1.7/8"X12 | 62.5 | 63 | 62.5 | 48 | |

注：螺母及衬套需另行订货。管子直径D为公制时，配用螺母及衬套分别选用NB200、NB500。管子直径为英制时，配用螺母及衬套分别选用NB200、NB300。 Nut and sleeve should be ordered separately. The nut NB200 and sleeve NB500 is suitable for metric tube, the nut NB200 and sleeve NB300 is suitable for inch tube.

美制螺纹JIC 74° 锥面扩口接头 JIC 74° Cone Flared Tube Fittings

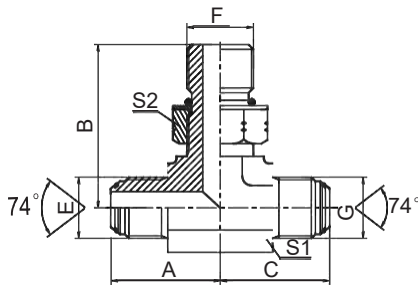

AJOJ-OG

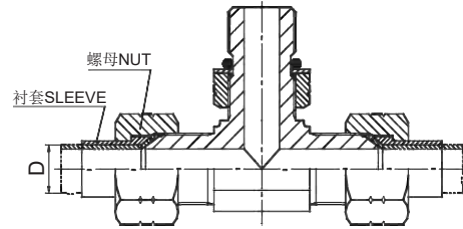

JIC外螺纹 / SAE
外螺纹O形圈 / JIC外螺纹
JIC MALE / SAE
O-RING BOSS / JIC MALE

| 代号 PART NO. | 螺 纹 THREAD | | | O形圈 O-RING | F端 | 尺 寸 DIMENSIONS | | | | |
|-----------------|------------|------------|------------|---------------|------------|----------------|------|------|----|----|
| | E | F | G | | | A | B | C | S1 | S2 |
| AJOJ-02OG | 5/16"X24 | 5/16"X24 | 5/16"X24 | | 6.07X1.63 | 21 | 23 | 21 | 11 | 12 |
| AJOJ-03OG | 3/8"X24 | 3/8"X24 | 3/8"X24 | | 7.65X1.63 | 22 | 23 | 22 | 11 | 14 |
| AJOJ-04OG | 7/16"X20 | 7/16"X20 | 7/16"X20 | | 8.92X1.83 | 24.5 | 27.2 | 24.5 | 11 | 17 |
| AJOJ-05-04-05OG | 1/2"X20 | 7/16"X20 | 1/2"X20 | | 8.92X1.83 | 26.6 | 30 | 26.6 | 14 | 17 |
| AJOJ-05OG | 1/2"X20 | 1/2"X20 | 1/2"X20 | | 10.52X1.83 | 26.6 | 29 | 26.6 | 14 | 17 |
| AJOJ-06-04-06OG | 9/16"X18 | 7/16"X20 | 9/16"X18 | | 8.92X1.83 | 26.9 | 30 | 26.9 | 14 | 17 |
| AJOJ-06-05-06OG | 9/16"X18 | 1/2"X20 | 9/16"X18 | | 10.52X1.83 | 26.9 | 30 | 26.9 | 14 | 17 |
| AJOJ-06OG | 9/16"X18 | 9/16"X18 | 9/16"X18 | | 11.89X1.98 | 26.9 | 31.8 | 26.9 | 14 | 19 |
| AJOJ-06-08-06OG | 9/16"X18 | 3/4"X16 | 9/16"X18 | | 16.36X2.21 | 30 | 37.5 | 30 | 19 | 24 |
| AJOJ-08-06-08OG | 3/4"X16 | 9/16"X18 | 3/4"X16 | | 11.89X1.98 | 32 | 33.5 | 32 | 19 | 19 |
| AJOJ-08OG | 3/4"X16 | 3/4"X16 | 3/4"X16 | | 16.36X2.21 | 33 | 36.8 | 33 | 19 | 24 |
| AJOJ-10-08-10OG | 7/8"X14 | 3/4"X16 | 7/8"X14 | | 16.36X2.21 | 37.8 | 39.5 | 37.8 | 22 | 24 |
| AJOJ-10OG | 7/8"X14 | 7/8"X14 | 7/8"X14 | | 19.18X2.46 | 37.8 | 44 | 37.8 | 22 | 27 |
| AJOJ-12-08-12OG | 1.1/16"X12 | 3/4"X16 | 1.1/16"X12 | | 16.36X2.21 | 44.2 | 43 | 44.2 | 27 | 24 |
| AJOJ-12-10-12OG | 1.1/16"X12 | 7/8"X14 | 1.1/16"X12 | | 19.18X2.46 | 44.2 | 49 | 44.2 | 27 | 27 |
| AJOJ-12OG | 1.1/16"X12 | 1.1/16"X12 | 1.1/16"X12 | | 23.47X2.95 | 44.2 | 51 | 44.2 | 27 | 32 |
| AJOJ-14OG | 1.3/16"X12 | 1.3/16"X12 | 1.3/16"X12 | | 26.62X2.95 | 48.5 | 56 | 48.5 | 33 | 38 |
| AJOJ-16-14-16OG | 1.5/16"X12 | 1.3/16"X12 | 1.5/16"X12 | | 26.62X2.95 | 49 | 56 | 49 | 33 | 38 |
| AJOJ-16OG | 1.5/16"X12 | 1.5/16"X12 | 1.5/16"X12 | | 29.74X2.95 | 48.8 | 54.5 | 48.8 | 33 | 41 |
| AJOJ-16-20-16OG | 1.5/16"X12 | 1.5/8"X12 | 1.5/16"X12 | | 37.46X3.00 | 54 | 59.5 | 54 | 41 | 50 |
| AJOJ-20-16-20OG | 1.5/8"X12 | 1.5/16"X12 | 1.5/8"X12 | | 29.74X2.95 | 55.5 | 59.5 | 55.5 | 41 | 41 |
| AJOJ-20OG | 1.5/8"X12 | 1.5/8"X12 | 1.5/8"X12 | | 37.46X3.00 | 55.3 | 59 | 55.3 | 41 | 50 |
| AJOJ-24OG | 1.7/8"X12 | 1.7/8"X12 | 1.7/8"X12 | | 43.69X3.00 | 62.5 | 63 | 62.5 | 48 | 55 |

注：螺母及衬套需另行订货。管子直径D为公制时，配用螺母及衬套分别选用NB200、NB500。管子直径为英制时，配用螺母及衬套分别选用NB200、NB300。 Nut and sleeve should be ordered separately. The nut NB200 and sleeve NB500 is suitable for metric tube, the nut NB200 and sleeve NB300 is suitable for inch tube.

H

美制螺纹JIC 74° 锥面扩口接头 JIC 74° Cone Flared Tube Fittings

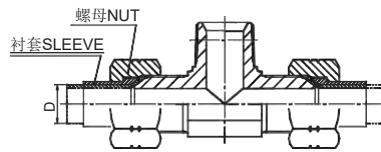
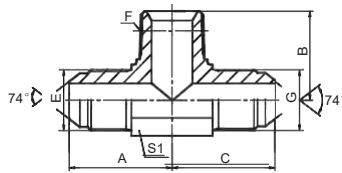

AJTJ-SP

JIC外螺纹 / 英
锥管外螺纹 / JIC外螺纹
JIC MALE /
BSPT MALE / JIC MALE

| 代号 PART NO. | 螺 纹 THREAD | | | 尺 寸 DIMENSIONS | | | | |
|-----------------|------------|------------|------------|----------------|------|------|----|--|
| | E | F | G | A | B | C | S1 | |
| AJTJ-04SP | 7/16"X20 | R1/4"X19 | 7/16"X20 | 26.6 | 25.5 | 26.6 | 14 | |
| AJTJ-04-02-04SP | 7/16"X20 | R1/8"X28 | 7/16"X20 | 24.5 | 21 | 24.5 | 11 | |
| AJTJ-06SP | 9/16"X18 | R3/8"X19 | 9/16"X18 | 28.5 | 28.5 | 28.5 | 16 | |
| AJTJ-06-04-06SP | 9/16"X18 | R1/4"X19 | 9/16"X18 | 26.9 | 25.5 | 26.9 | 14 | |
| AJTJ-08SP | 3/4"X16 | R1/2"X14 | 3/4"X16 | 34.8 | 36 | 34.8 | 22 | |
| AJTJ-08-06-08SP | 3/4"X16 | R3/8"X19 | 3/4"X16 | 32 | 30.5 | 32 | 19 | |
| AJTJ-10-08-10SP | 7/8"X14 | R1/2"X14 | 7/8"X14 | 37.8 | 36 | 37.8 | 22 | |
| AJTJ-12SP | 1.1/16"X12 | R3/4"X14 | 1.1/16"X12 | 44.2 | 43.5 | 44.2 | 27 | |
| AJTJ-16SP | 1.5/16"X12 | R1"X11 | 1.5/16"X12 | 49 | 50 | 49 | 33 | |
| AJTJ-20SP | 1.5/8"X12 | R1.1/4"X11 | 1.5/8"X12 | 55.5 | 56.5 | 55.5 | 41 | |
| AJTJ-24SP | 1.7/8"X12 | R1.1/2"X11 | 1.7/8"X12 | 62.5 | 62.5 | 62.5 | 48 | |

注：螺母及衬套需另行订货。管子直径D1为公制时，配用螺母及衬套分别选用NB200、NB500。管子直径为英制时，配用螺母及衬套分别选用NB200、NB300。Nut and sleeve should be ordered separately. The nut NB200 and sleeve NB500 is suitable for metric tube, the nut NB200 and sleeve NB300 is suitable for inch tube.

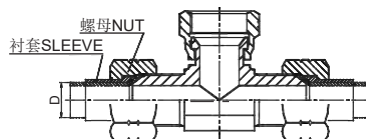
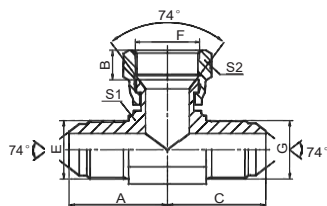

BJ

美制JIC外螺纹 / 美制
JIC内螺纹 / 美制JIC外螺纹
JIC MALE /
JIC FEMALE / JIC MALE

| 代号 PART NO. | 螺 纹 THREAD | | | 尺 寸 DIMENSIONS | | | | |
|----------------|------------|------------|------------|----------------|------|------|----|----|
| | E | F | G | A | B | C | S1 | S2 |
| BJ-04 | 7/16"X20 | 7/16"X20 | 7/16"X20 | 24.5 | 9 | 24.5 | 11 | 15 |
| BJ-05 | 1/2"X20 | 1/2"X20 | 1/2"X20 | 26.5 | 9.5 | 26.5 | 14 | 17 |
| BJ-06 | 9/16"X18 | 9/16"X18 | 9/16"X18 | 26.9 | 10.5 | 26.9 | 14 | 19 |
| BJ-08 | 3/4"X16 | 3/4"X16 | 3/4"X16 | 32 | 11 | 32 | 19 | 24 |
| BJ-10 | 7/8"X14 | 7/8"X14 | 7/8"X14 | 37.8 | 14 | 37.8 | 22 | 27 |
| BJ-12 | 1.1/16"X12 | 1.1/16"X12 | 1.1/16"X12 | 44.2 | 15 | 44.2 | 27 | 32 |
| BJ-14 | 1.3/16"X12 | 1.3/16"X12 | 1.3/16"X12 | 47.5 | 15 | 47.5 | 30 | 36 |
| BJ-16 | 1.5/16"X12 | 1.5/16"X12 | 1.5/16"X12 | 49 | 16 | 49 | 33 | 41 |
| BJ-20 | 1.5/8"X12 | 1.5/8"X12 | 1.5/8"X12 | 56 | 17 | 56 | 41 | 50 |
| BJ-24 | 1.7/8"X12 | 1.7/8"X12 | 1.7/8"X12 | 63.5 | 20 | 63.5 | 48 | 55 |
| BJ-32 | 2.1/2"X12 | 2.1/2"X12 | 2.1/2"X12 | 78 | 24.5 | 78 | 63 | 75 |

注：螺母及衬套需另行订货。管子直径D为公制时，配用螺母及衬套分别选用NB200、NB500。管子直径为英制时，配用螺母及衬套分别选用NB200、NB300。Nut and sleeve should be ordered separately. The nut NB200 and sleeve NB500 is suitable for metric tube, the nut NB200 and sleeve NB300 is suitable for inch tube.

美制螺纹JIC 74° 锥面扩口接头 JIC 74° Cone Flared Tube Fittings

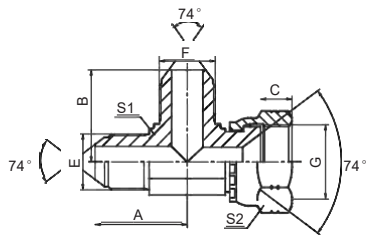

CJ

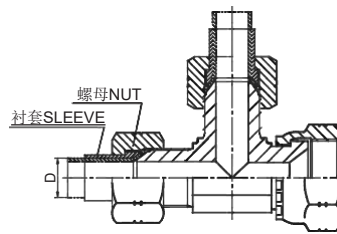

美制JIC外螺纹 / 美制
JIC外螺纹 / 美制JIC内螺纹
JIC MALE /
JIC MALE / JIC FEMALE

| 代号 PART NO. | 螺 纹 THREAD | | | 尺 寸 DIMENSIONS | | | | | |
|----------------|------------|------------|------------|----------------|------|------|----|----|--|
| | E | F | G | A | B | C | S1 | S2 | |
| CJ-04 | 7/16"X20 | 7/16"X20 | 7/16"X20 | 24.5 | 24.5 | 9 | 11 | 15 | |
| CJ-05 | 1/2"X20 | 1/2"X20 | 1/2"X20 | 26.6 | 26.6 | 9.5 | 14 | 17 | |
| CJ-06 | 9/16"X18 | 9/16"X18 | 9/16"X18 | 26.9 | 26.9 | 10.5 | 14 | 19 | |
| CJ-08 | 3/4"X16 | 3/4"X16 | 3/4"X16 | 32 | 32 | 9.5 | 19 | 24 | |
| CJ-10 | 7/8"X14 | 7/8"X14 | 7/8"X14 | 37.8 | 37.8 | 13 | 22 | 27 | |
| CJ-10-08-10 | 7/8"X14 | 7/8"X14 | 7/8"X14 | 37.8 | 34.8 | 13 | 22 | 27 | |
| CJ-12 | 1.1/16"X12 | 1.1/16"X12 | 1.1/16"X12 | 44.2 | 44.2 | 15 | 27 | 32 | |
| CJ-12-08-12 | 1.1/16"X12 | 1.1/16"X12 | 1.1/16"X12 | 44.2 | 37.9 | 15 | 27 | 32 | |
| CJ-14 | 1.3/16"X12 | 1.3/16"X12 | 1.3/16"X12 | 47.5 | 47.5 | 15 | 30 | 36 | |
| CJ-16 | 1.5/16"X12 | 1.5/16"X12 | 1.5/16"X12 | 49 | 49 | 16 | 33 | 41 | |
| CJ-20 | 1.5/8"X12 | 1.5/8"X12 | 1.5/8"X12 | 55.5 | 55.5 | 17 | 41 | 50 | |
| CJ-24 | 1.7/8"X12 | 1.7/8"X12 | 1.7/8"X12 | 63 | 63 | 20 | 48 | 55 | |
| CJ-32 | 2.1/2"X12 | 2.1/2"X12 | 2.1/2"X12 | 78 | 78 | 24.5 | 63 | 75 | |

注：螺母及衬套需另行订货。管子直径D为公制时，配用螺母及衬套分别选用NB200、NB500。管子直径为英制时，配用螺母及衬套分别选用NB200、NB300。 Nut and sleeve should be ordered separately. The nut NB200 and sleeve NB500 is suitable for metric tube, the nut NB200 and sleeve NB300 is suitable for inch tube.

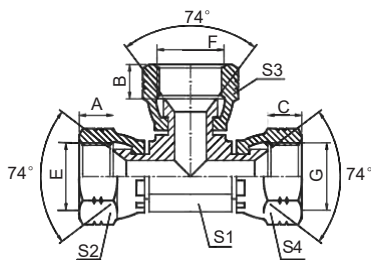

DJ

美制JIC内螺纹74° 内锥
JIC FEMALE 74° SEAT

| 代号 PART NO. | 螺 纹 THREAD | | | 尺 寸 DIMENSIONS | | | | |
|----------------|------------|------------|------------|----------------|----|----------|--|--|
| | E | F | G | A,B,C | S1 | S2,S3,S4 | | |
| DJ-04 | 7/16"X20 | 7/16"X20 | 7/16"X20 | 9 | 11 | 15 | | |
| DJ-05 | 1/2"X20 | 1/2"X20 | 1/2"X20 | 9.5 | 11 | 17 | | |
| DJ-06 | 9/16"X18 | 9/16"X18 | 9/16"X18 | 10.5 | 14 | 19 | | |
| DJ-08 | 3/4"X16 | 3/4"X16 | 3/4"X16 | 11 | 16 | 24 | | |
| DJ-10 | 7/8"X14 | 7/8"X14 | 7/8"X14 | 13 | 22 | 27 | | |
| DJ-12 | 1.1/16"X12 | 1.1/16"X12 | 1.1/16"X12 | 15 | 24 | 32 | | |
| DJ-16 | 1.5/16"X12 | 1.5/16"X12 | 1.5/16"X12 | 16 | 33 | 41 | | |

美制螺纹JIC 74° 锥面扩口接头 JIC 74° Cone Flared Tube Fittings

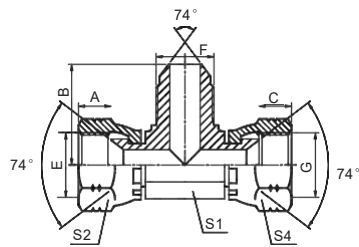

EJ

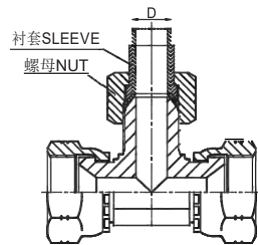

美制JIC内螺纹 / 美制
JIC外螺纹 / 美制JIC内螺纹
JIC FEMALE /
JIC MALE / JIC FEMALE

| 代号 PART NO. | 螺 纹 THREAD | | | 尺 寸 DIMENSIONS | | | | | |
|----------------|------------|------------|------------|----------------|--|------|------|----|-------|
| | E | F | G | | | A, C | B | S1 | S2,S4 |
| EJ-04 | 7/16"X20 | 7/16"X20 | 7/16"X20 | | | 9 | 24.5 | 11 | 15 |
| EJ-06 | 9/16"X18 | 9/16"X18 | 9/16"X18 | | | 10.5 | 26.9 | 14 | 19 |
| EJ-08 | 3/4"X16 | 3/4"X16 | 3/4"X16 | | | 11 | 32 | 19 | 24 |
| EJ-10 | 7/8"X14 | 7/8"X14 | 7/8"X14 | | | 13 | 37.8 | 22 | 27 |
| EJ-12 | 1.1/16"X12 | 1.1/16"X12 | 1.1/16"X12 | | | 15 | 44.2 | 24 | 32 |
| EJ-16 | 1.5/16"X12 | 1.5/16"X12 | 1.5/16"X12 | | | 16 | 49 | 33 | 41 |
| EJ-20 | 1.5/8"X12 | 1.5/8"X12 | 1.5/8"X12 | | | 17 | 56.5 | 41 | 50 |
| EJ-24 | 1.7/8"X12 | 1.7/8"X12 | 1.7/8"X12 | | | 20 | 63 | 48 | 55 |

注：螺母及衬套需另行订货。管子直径D为公制时，配用螺母及衬套分别选用NB200、NB500。管子直径为英制时，配用螺母及衬套分别选用NB200、NB300。 Nut and sleeve should be ordered separately. The nut NB200 and sleeve NB500 is suitable for metric tube, the nut NB200 and sleeve NB300 is suitable for inch tube.

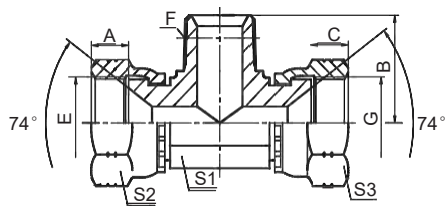

EJNJ

JIC内螺纹 / 布锥管外螺纹 / JIC内螺纹
JIC FEMALE / NPT MALE / JIC FEMALE

| 代号 PART NO. | 螺 纹 THREAD | | | 尺 寸 DIMENSIONS | | | | | | |
|----------------|------------|--------------|------------|----------------|--|------|------|----|----|----|
| | E | F | G | | | A,C | B | S1 | S2 | S3 |
| EJNJ-04 | 7/16"X20 | Z1/4"X18 | 7/16"X20 | | | 9 | 25.5 | 14 | 17 | 17 |
| EJNJ-05-04-05 | 1/2"X20 | Z1/4"X18 | 1/2"X20 | | | 9 | 25.5 | 14 | 17 | 17 |
| EJNJ-06 | 9/16"X18 | Z3/8"X18 | 9/16"X18 | | | 10.5 | 29.5 | 16 | 19 | 19 |
| EJNJ-06-04-06 | 9/16"X18 | Z1/4"X18 | 9/16"X18 | | | 10.5 | 25.5 | 14 | 19 | 19 |
| EJNJ-08 | 3/4"X16 | Z1/2"X14 | 3/4"X16 | | | 10.5 | 36.7 | 22 | 24 | 24 |
| EJNJ-08-06-08 | 3/4"X16 | Z3/8"X18 | 3/4"X16 | | | 10.5 | 31 | 19 | 24 | 24 |
| EJNJ-10-08-10 | 7/8"X14 | Z1/2"X14 | 7/8"X14 | | | 12 | 36.7 | 22 | 27 | 27 |
| EJNJ-12 | 1.1/16"X12 | Z3/4"X14 | 1.1/16"X12 | | | 15 | 44 | 27 | 32 | 32 |
| EJNJ-16 | 1.5/16"X12 | Z1"X11.5 | 1.5/16"X12 | | | 16 | 50 | 33 | 41 | 41 |
| EJNJ-20 | 1.5/8"X12 | Z1.1/4"X11.5 | 1.5/8"X12 | | | 17 | 54.5 | 41 | 50 | 50 |
| EJNJ-24 | 1.7/8"X12 | Z1.1/2"X11.5 | 1.7/8"X12 | | | 20 | 63 | 48 | 60 | 60 |

美制螺纹JIC 74° 锥面扩口接头 JIC 74° Cone Flared Tube Fittings

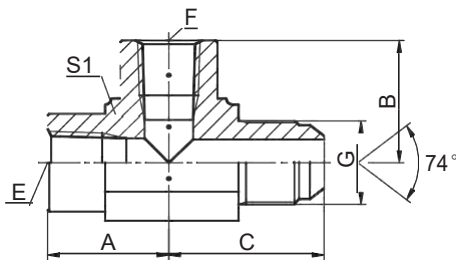

HNNJ

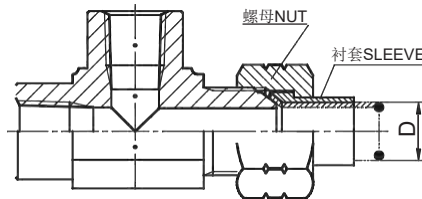

HNNJ-RN

布锥管内螺纹 /
布锥管内螺纹 / JIC外螺纹
NPT FEMALE /
NPT FEMALE / JIC MALE

| 代号 PART NO. | 螺 纹 THREAD | | | 尺 寸 DIMENSIONS | | | | |
|----------------|------------|----------|------------|----------------|------|------|----|--|
| | E | F | G | A | B | C | S1 | |
| HNNJ-04 | Z1/4"X18 | Z1/4"X18 | 7/16"X20 | 22.4 | 22.4 | 29.5 | 19 | |
| HNNJ-04-04-05 | Z1/4"X18 | Z1/4"X18 | 1/2"X20 | 22.4 | 22.4 | 29.5 | 19 | |
| HNNJ-04-04-06 | Z1/4"X18 | Z1/4"X18 | 9/16"X18 | 22.4 | 22.4 | 31.2 | 19 | |
| HNNJ-06 | Z3/8"X18 | Z3/8"X18 | 9/16"X18 | 25.9 | 25.9 | 33.5 | 24 | |
| HNNJ-06-06-08 | Z3/8"X18 | Z3/8"X18 | 3/4"X16 | 25.9 | 25.9 | 36 | 24 | |
| HNNJ-08 | Z1/2"X14 | Z1/2"X14 | 3/4"X16 | 31.2 | 31.2 | 39.5 | 30 | |
| HNNJ-08-08-10 | Z1/2"X14 | Z1/2"X14 | 7/8"X14 | 31.2 | 31.2 | 42.5 | 30 | |
| HNNJ-12 | Z3/4"X14 | Z3/4"X14 | 1.1/16"X12 | 34.5 | 34.5 | 48 | 33 | |
| HNNJ-16 | Z1"X11.5 | Z1"X11.5 | 1.5/16"X12 | 41.1 | 41.1 | 55.1 | 41 | |

注：螺母及衬套需另行订货。管子直径D为公制时，配用螺母及衬套分别选用NB200、NB500。管子直径为英制时，配用螺母及衬套分别选用NB200、NB300。 Nut and sleeve should be ordered separately. The nut NB200 and sleeve NB500 is suitable for metric tube, the nut NB200 and sleeve NB300 is suitable for inch tube.

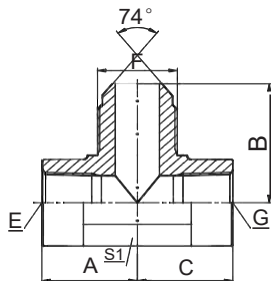

JNJJ

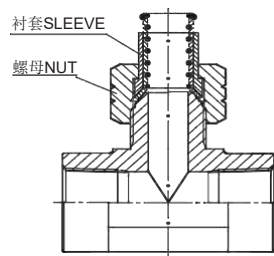

JNJJ-RN

布锥管内螺纹 / JIC
外螺纹 / 布锥管内螺纹
NPT FEMALE / JIC
MALE / NPT FEMALE

| 代号 PART NO. | 螺 纹 THREAD | | | 尺 寸 DIMENSIONS | | | | |
|----------------|------------|------------|----------|----------------|------|------|----|--|
| | E | F | G | A | B | C | S1 | |
| JNJJ-02-04-02 | Z1/8"X27 | 7/16"X20 | Z1/8"X27 | 16.8 | 26.5 | 16.8 | 16 | |
| JNJJ-04 | Z1/4"X18 | 7/16"X20 | Z1/4"X18 | 22.4 | 29.5 | 22.4 | 19 | |
| JNJJ-04-06-04 | Z1/4"X18 | 9/16"X18 | Z1/4"X18 | 22.4 | 30 | 22.4 | 19 | |
| JNJJ-06 | Z3/8"X18 | 9/16"X18 | Z3/8"X18 | 25.9 | 33.5 | 25.9 | 24 | |
| JNJJ-08-06-08 | Z1/2"X14 | 9/16"X18 | Z1/2"X14 | 31.2 | 36.5 | 31.2 | 30 | |
| JNJJ-08 | Z1/2"X14 | 3/4"X16 | Z1/2"X14 | 31.2 | 39.5 | 31.2 | 30 | |
| JNJJ-08-10-08 | Z1/2"X14 | 7/8"X14 | Z1/2"X14 | 31.2 | 42.5 | 31.2 | 30 | |
| JNJJ-12 | Z3/4"X14 | 1.1/16"X12 | Z3/4"X14 | 34.5 | 48 | 34.5 | 33 | |
| JNJJ-16 | Z1"X11.5 | 1.5/16"X12 | Z1"X11.5 | 41.1 | 55.1 | 41.1 | 41 | |

注：螺母及衬套需另行订货。管子直径D为公制时，配用螺母及衬套分别选用NB200、NB500。管子直径为英制时，配用螺母及衬套分别选用NB200、NB300。 Nut and sleeve should be ordered separately. The nut NB200 and sleeve NB500 is suitable for metric tube, the nut NB200 and sleeve NB300 is suitable for inch tube.

H

美制螺纹JIC 74° 锥面扩口接头 JIC 74° Cone Flared Tube Fittings

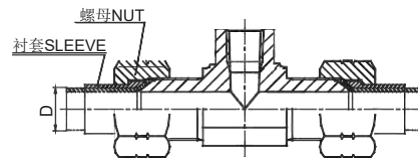
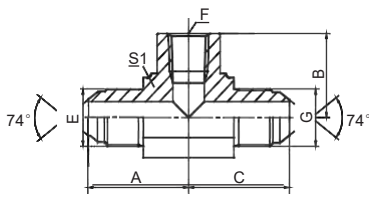

JIC外螺纹 / 布锥管
内螺纹 / JIC外螺纹
JIC MALE / NPT
FEMALE / JIC MALE

KJNJ

| 代号 PART NO. | 螺 纹 THREAD | | | 尺 寸 DIMENSIONS | | | | |
|----------------|------------|--------------|------------|----------------|------|------|----|--|
| | E | F | G | A | B | C | S1 | |
| KJNJ-04 | 7/16"X20 | Z1/4"X18 | 7/16"X20 | 29.5 | 22.4 | 29.5 | 19 | |
| KJNJ-04-02-04 | 7/16"X20 | Z1/8"X27 | 7/16"X20 | 26.5 | 16.8 | 26.5 | 16 | |
| KJNJ-05-02-05 | 1/2"X20 | Z1/8"X27 | 1/2"X20 | 27.5 | 16.8 | 27.5 | 16 | |
| KJNJ-05-04-05 | 1/2"X20 | Z1/4"X18 | 1/2"X20 | 29.5 | 22.4 | 29.5 | 19 | |
| KJNJ-06 | 9/16"X18 | Z3/8"X18 | 9/16"X18 | 33.5 | 25.9 | 33.5 | 24 | |
| KJNJ-06-04-06 | 9/16"X18 | Z1/4"X18 | 9/16"X18 | 30 | 22.4 | 30 | 19 | |
| KJNJ-08 | 3/4"X16 | Z1/2"X14 | 3/4"X16 | 39.5 | 31.2 | 39.5 | 30 | |
| KJNJ-08-04-08 | 3/4"X16 | Z1/4"X18 | 3/4"X16 | 31.6 | 22.4 | 32 | 19 | |
| KJNJ-08-06-08 | 3/4"X16 | Z3/8"X18 | 3/4"X16 | 36 | 25.9 | 36 | 24 | |
| KJNJ-10-08-10 | 7/8"X14 | Z1/2"X14 | 7/8"X14 | 42.5 | 31.2 | 42.5 | 30 | |
| KJNJ-10-12-10 | 7/8"X14 | Z3/4"X14 | 7/8"X14 | 44.5 | 34.5 | 44.5 | 33 | |
| KJNJ-12 | 1.1/16"X12 | Z3/4"X14 | 1.1/16"X12 | 48 | 34.5 | 48 | 33 | |
| KJNJ-12-08-12 | 1.1/16"X12 | Z1/2"X14 | 1.1/16"X12 | 46 | 31.2 | 46 | 30 | |
| KJNJ-14-12-14 | 1.3/16"X12 | Z3/4"X14 | 1.3/16"X12 | 48.5 | 34.5 | 48.5 | 33 | |
| KJNJ-16 | 1.5/16"X12 | Z1"X11.5 | 1.5/16"X12 | 54 | 41.1 | 54 | 41 | |
| KJNJ-16-12-16 | 1.5/16"X12 | Z3/4"X14 | 1.5/16"X12 | 49 | 34.5 | 49 | 33 | |
| KJNJ-20 | 1.5/8"X12 | Z1.1/4"X11.5 | 1.5/8"X12 | 59.4 | 43.2 | 59.4 | 48 | |
| KJNJ-24 | 1.7/8"X12 | Z1.1/2"X11.5 | 1.7/8"X12 | 73.4 | 52.8 | 73.4 | 63 | |

注：螺母及衬套需另行订货。管子直径D为公制时，配用螺母及衬套分别选用NB200、NB500。管子直径为英制时，配用螺母及衬套分别选用NB200、NB300。 Nut and sleeve should be ordered separately. The nut NB200 and sleeve NB500 is suitable for metric tube, the nut NB200 and sleeve NB300 is suitable for inch tube.

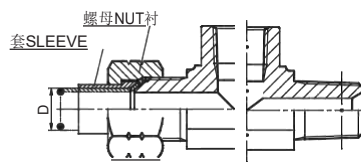
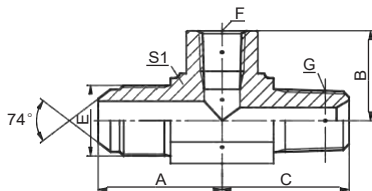

JIC外螺纹 / 布锥管
内螺纹 / 布锥管外螺纹
JIC MALE / NPT
FEMALE / NPT MALE

KJNN

KJNN-RN

| 代号 PART NO. | 螺 纹 THREAD | | | 尺 寸 DIMENSIONS | | | | |
|----------------|------------|----------|----------|----------------|------|------|----|--|
| | E | F | G | A | B | C | S1 | |
| KJNN-04-02-02 | 7/16"X20 | Z1/8"X27 | Z1/8"X27 | 26.5 | 16.8 | 24.5 | 16 | |
| KJNN-04 | 7/16"X20 | Z1/4"X18 | Z1/4"X18 | 29.5 | 22.4 | 28 | 19 | |
| KJNN-06-04-04 | 9/16"X18 | Z1/4"X18 | Z1/4"X18 | 30 | 22.4 | 28 | 19 | |
| KJNN-06 | 9/16"X18 | Z3/8"X18 | Z3/8"X18 | 33.5 | 25.9 | 33.5 | 24 | |
| KJNN-08-06-06 | 3/4"X16 | Z3/8"X18 | Z3/8"X18 | 36 | 25.9 | 33.5 | 24 | |
| KJNN-08 | 3/4"X16 | Z1/2"X14 | Z1/2"X14 | 39.5 | 31.2 | 41.2 | 30 | |
| KJNN-10-08-08 | 7/8"X14 | Z1/2"X14 | Z1/2"X14 | 42.5 | 31.2 | 41.2 | 30 | |
| KJNN-12 | 1.1/16"X12 | Z3/4"X14 | Z3/4"X14 | 48 | 34.5 | 45.2 | 33 | |
| KJNN-14-12-12 | 1.3/16"X12 | Z3/4"X14 | Z3/4"X14 | 48.5 | 34.5 | 45.2 | 33 | |
| KJNN-16 | 1.5/16"X12 | Z1"X11.5 | Z1"X11.5 | 55.1 | 41.1 | 54.5 | 41 | |

注：螺母及衬套需另行订货。管子直径D为公制时，配用螺母及衬套分别选用NB200、NB500。管子直径为英制时，配用螺母及衬套分别选用NB200、NB300。 Nut and sleeve should be ordered separately. The nut NB200 and sleeve NB500 is suitable for metric tube, the nut NB200 and sleeve NB300 is suitable for inch tube.

美制螺纹JIC 74° 锥面扩口接头 JIC 74° Cone Flared Tube Fittings

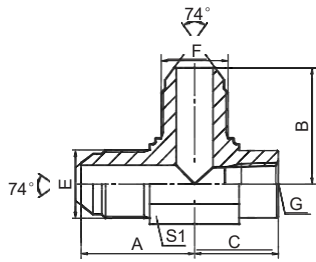

LJJN

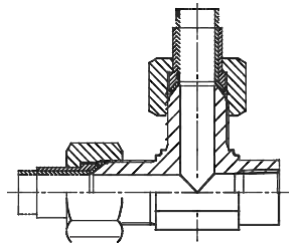

美制JIC外螺纹 / 美制
JIC外螺纹 / 布锥管内螺纹
JIC MALE / JIC
MALE / NPT FEMALE

| 代号 PART NO. | 螺纹 THREAD | | | 尺寸 DIMENSIONS | | | | | |
|----------------|------------|------------|--------------|---------------|--|------|------|------|----|
| | E | F | G | | | A | B | C | S1 |
| LJJN-04 | 7/16"X20 | 7/16"X20 | Z1/4"X18 | | | 30.9 | 30.9 | 25.1 | 19 |
| LJJN-04-04-02 | 7/16"X20 | 7/16"X20 | Z1/8"X27 | | | 27.5 | 27.5 | 16.8 | 16 |
| LJJN-05-05-02 | 1/2"X20 | 1/2"X20 | Z1/8"X27 | | | 27.5 | 27.5 | 16.8 | 16 |
| LJJN-05-05-04 | 1/2"X20 | 1/2"X20 | Z1/4"X18 | | | 29.5 | 29.5 | 22.4 | 19 |
| LJJN-06 | 9/16"X18 | 9/16"X18 | Z3/8"X18 | | | 33.5 | 33.5 | 26.8 | 24 |
| LJJN-06-06-04 | 9/16"X18 | 9/16"X18 | Z1/4"X18 | | | 30 | 30 | 22.5 | 19 |
| LJJN-08 | 3/4"X16 | 3/4"X16 | Z1/2"X14 | | | 39.5 | 39.5 | 33 | 30 |
| LJJN-08-08-06 | 3/4"X16 | 3/4"X16 | Z3/8"X18 | | | 36 | 36 | 25.9 | 24 |
| LJJN-10-10-08 | 7/8"X14 | 7/8"X14 | Z1/2"X14 | | | 42.5 | 42.5 | 31.2 | 30 |
| LJJN-12 | 1.1/16"X12 | 1.1/16"X12 | Z3/4"X14 | | | 48 | 48 | 39 | 33 |
| LJJN-14-14-12 | 1.3/16"X12 | 1.3/16"X12 | Z3/4"X14 | | | 48.5 | 48.5 | 34.5 | 33 |
| LJJN-16 | 1.5/16"X12 | 1.5/16"X12 | Z1"X11.5 | | | 55.1 | 55.1 | 43.9 | 41 |
| LJJN-20 | 1.5/8"X12 | 1.5/8"X12 | Z1.1/4"X11.5 | | | 59.2 | 59.2 | 43.3 | 48 |
| LJJN-24 | 1.7/8"X12 | 1.7/8"X12 | Z1.1/2"X11.5 | | | 73.4 | 73.4 | 52.8 | 63 |

H

美制螺纹JIC 74° 锥面扩口接头 JIC 74° Cone Flared Tube Fittings

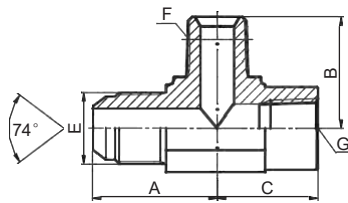

LJNN

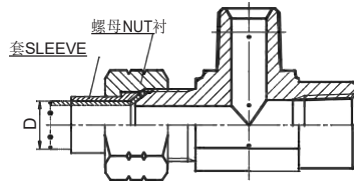

LJNN-RN

美制JIC外螺纹 / 布锥
管外螺纹 / 布锥管内螺纹
JIC MALE / NPT
MALE / NPT FEMALE

| 代号 PART NO. | 螺 纹 THREAD | | | 尺 寸 DIMENSIONS | | | | |
|----------------|------------|----------|----------|----------------|------|------|----|--|
| | E | F | G | A | B | C | S1 | |
| LJNN-04 | 7/16"X20 | Z1/4"X18 | Z1/4"X18 | 29.5 | 28 | 22.4 | 19 | |
| LJNN-04-02-02 | 7/16"X20 | Z1/8"X27 | Z1/8"X27 | 27.5 | 24.5 | 16.8 | 16 | |
| LJNN-06 | 9/16"X18 | Z3/8"X18 | Z3/8"X18 | 33.5 | 33.5 | 25.9 | 24 | |
| LJNN-06-04-04 | 9/16"X18 | Z1/4"X18 | Z1/4"X18 | 31.2 | 28 | 22.4 | 19 | |
| LJNN-08 | 3/4"X16 | Z1/2"X14 | Z1/2"X14 | 39.5 | 41.2 | 31.2 | 30 | |
| LJNN-08-06-06 | 3/4"X16 | Z3/8"X18 | Z3/8"X18 | 36 | 33.5 | 25.9 | 24 | |
| LJNN-10-08-08 | 7/8"X14 | Z1/2"X14 | Z1/2"X14 | 42.5 | 41.2 | 31.2 | 30 | |
| LJNN-12 | 1.1/16"X12 | Z3/4"X14 | Z3/4"X14 | 48 | 45.2 | 34.5 | 33 | |
| LJNN-14-12-12 | 1.3/16"X12 | Z3/4"X14 | Z3/4"X14 | 48.5 | 45.2 | 34.5 | 33 | |
| LJNN-16 | 1.5/16"X12 | Z1"X11.5 | Z1"X11.5 | 55.1 | 54.5 | 41.1 | 41 | |

注：螺母及衬套需另行订货。管子直径D为公制时，配用螺母及衬套分别选用NB200、NB500。管子直径为英制时，配用螺母及衬套分别选用NB200、NB300。 Nut and sleeve should be ordered separately. The nut NB200 and sleeve NB500 is suitable for metric tube, the nut NB200 and sleeve NB300 is suitable for inch tube.

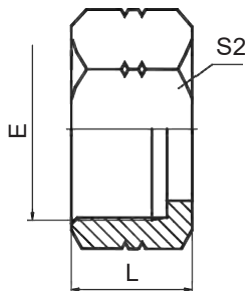

NB200

JIC螺母
JIC TRIPLE LOCK NUT

| 代号 PART NO. | 螺 纹 THREAD | 管子外径及配用管套 TUBE O.D. & SLEEVE | | | | 尺 寸 DIMENSIONS | | |
|----------------|------------|------------------------------|-----------------|----|-------------------|----------------|----|--|
| | | In. | 英制管套INCH SLEEVE | mm | 公制管套METRIC SLEEVE | L | S2 | |
| NB200-04 | 7/16"X20 | 1/4" | NB300-04 | 6 | NB500-06 | 15.8 | 14 | |
| NB200-05 | 1/2"X20 | 5/16" | NB300-05 | 8 | NB500-08 | 17.3 | 17 | |
| NB200-06 | 9/16"X18 | 3/8" | NB300-06 | 10 | NB500-10 | 18.5 | 19 | |
| NB200-08 | 3/4"X16 | 1/2" | NB300-08 | 12 | NB500-12 | 21.6 | 24 | |
| NB200-10 | 7/8"X14 | | | 14 | NB500-14 | 24.9 | 27 | |
| NB200-10 | 7/8"X14 | | | 15 | NB500-15 | 24.9 | 27 | |
| NB200-10 | 7/8"X14 | 5/8" | NB300-10 | 16 | NB500-16 | 24.9 | 27 | |
| NB200-12 | 1.1/16"X12 | 3/4" | NB300-12 | 18 | NB500-18 | 26.2 | 32 | |
| NB200-12A | 1.1/16"X12 | | | 20 | NB500-20A | 26.2 | 32 | |
| NB200-14 | 1.3/16"X12 | | | 20 | NB500-20 | 27.7 | 36 | |
| NB200-14 | 1.3/16"X12 | 7/8" | NB300-14 | 22 | NB500-22 | 27.7 | 36 | |
| NB200-16 | 1.5/16"X12 | 1" | NB300-16 | 25 | NB500-25 | 28.7 | 38 | |
| NB200-20 | 1.5/8"X12 | | | 28 | NB500-28 | 31.2 | 50 | |
| NB200-20 | 1.5/8"X12 | | | 30 | NB500-30 | 31.2 | 50 | |
| NB200-20 | 1.5/8"X12 | 1.1/4" | NB300-20 | 32 | NB500-32 | 31.2 | 50 | |
| NB200-24 | 1.7/8"X12 | | | 35 | NB500-35 | 36.1 | 60 | |
| NB200-24 | 1.7/8"X12 | 1.1/2" | NB300-24 | 38 | NB500-38 | 36.1 | 60 | |
| NB200-32 | 2.1/2"X12 | 2" | NB300-32 | 50 | NB500-50 | 44.5 | 75 | |

美制螺纹JIC 74° 锥面扩口接头 JIC 74° Cone Flared Tube Fittings

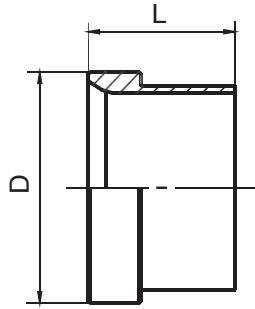

NB300

JIC英制管套
JIC INCH SLEEVE

| 代号 PART NO. | 螺 纹 THREAD | 管子外径 TUBE O.D. In. | 尺 寸 DIMENSIONS | | | |
|----------------|---------------|--------------------------|-------------------|------|--|--|
| | | | D | L | | |
| NB300-04 | 7/16"X20 | 1/4" | 9.73 | 10.4 | | |
| NB300-05 | 1/2"X20 | 5/16" | 11.3 | 11.2 | | |
| NB300-06 | 9/16"X18 | 3/8" | 12.75 | 12.7 | | |
| NB300-08 | 3/4"X16 | 1/2" | 17.32 | 14.2 | | |
| NB300-10 | 7/8"X14 | 5/8" | 20.24 | 16.8 | | |
| NB300-12 | 1.1/16"X12 | 3/4" | 24.69 | 17.3 | | |
| NB300-14 | 1.3/16"X12 | 7/8" | 27.86 | 19.3 | | |
| NB300-16 | 1.5/16"X12 | 1" | 31.04 | 19.8 | | |
| NB300-20 | 1.5/8"X12 | 1.1/4" | 38.96 | 23.1 | | |
| NB300-24 | 1.7/8"X12 | 1.1/2" | 45.31 | 28.4 | | |
| NB300-32 | 2.1/2"X12 | 2" | 61.19 | 30.2 | | |

H

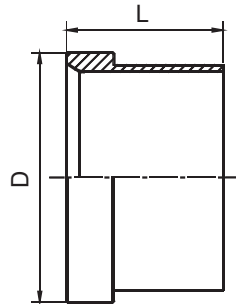





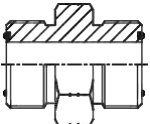
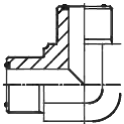
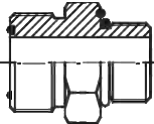
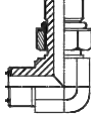
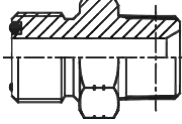
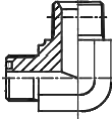
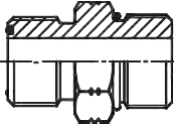
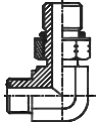

NB500

JIC公制管套
JIC METRIC SLEEVE

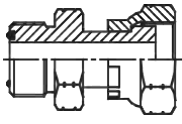
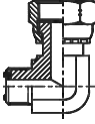
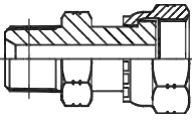
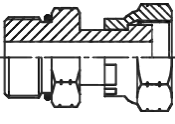
| 代号 PART NO. | 螺 纹 THREAD | 管子外径 TUBE O.D. mm | 尺 寸 DIMENSIONS | | | |
|----------------|---------------|-------------------------|-------------------|------|--|--|
| | | | D | L | | |
| NB500-06 | 7/16"X20 | 6 | 9.7 | 10.4 | | |
| NB500-08 | 1/2"X20 | 8 | 11.3 | 11.2 | | |
| NB500-10 | 9/16"X18 | 10 | 12.7 | 12.7 | | |
| NB500-12 | 3/4"X16 | 12 | 17.3 | 14.2 | | |
| NB500-14 | 7/8"X14 | 14 | 20.2 | 16.8 | | |
| NB500-15 | 7/8"X14 | 15 | 20.2 | 16.8 | | |
| NB500-16 | 7/8"X14 | 16 | 20.2 | 16.8 | | |
| NB500-18 | 1.1/16"X12 | 18 | 24.7 | 17.3 | | |
| NB500-20 | 1.3/16"X12 | 20 | 27.8 | 19.3 | | |
| NB500-22 | 1.3/16"X12 | 22 | 27.8 | 19.3 | | |
| NB500-25 | 1.5/16"X12 | 25 | 31 | 19.8 | | |
| NB500-28 | 1.5/8"X12 | 28 | 38.9 | 23.1 | | |
| NB500-30 | 1.5/8"X12 | 30 | 38.9 | 23.1 | | |
| NB500-32 | 1.5/8"X12 | 32 | 38.9 | 23.1 | | |
| NB500-35 | 1.7/8"X12 | 35 | 45.3 | 28.4 | | |
| NB500-38 | 1.7/8"X12 | 38 | 45.3 | 28.4 | | |
| NB500-50 | 2.1/2"X12 | 50 | 61.2 | 30.2 | | |

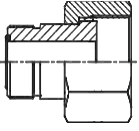
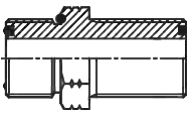
型号索引 Part NO. Index

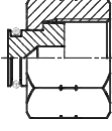
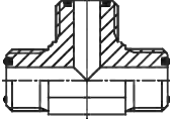
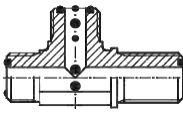
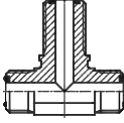
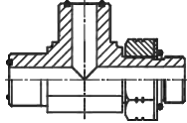
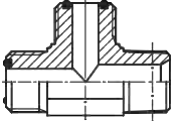
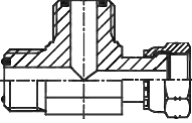
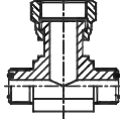
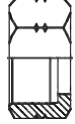
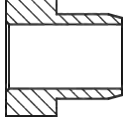
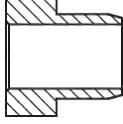
| | | | | | |
|---|--|--|---|---|---|
|  1F PI1 |  1F9 PI2 |  1FH PI2 |  1FH9-OG PI3 |  1FN PI4 |  1FN9 PI5 |
|  1FO PI6 |  1FO9-OG PI7 |  1FO9-UGL PI8 |  2F PI9 |  2F9 PI10 |  2NF PI10 |
|  2OF PI11 |  4F PI11 |  5F-S PI12 |  6F PI13 |  8F PI13 |  9F PI14 |
|  AF PI14 |  AFF6F PI15 |  AF6FF PI15 |  AFFO-OG PI16 |  AFFN PI16 |  CF PI17 |
|  BF PI17 |  NB200-F PI18 |  NB300-F PI18 |  NB500-F PI19 | | |
| | | | | | |
| | | | | | |

美制螺纹O型圈平面密封接头 ORFS Fittings

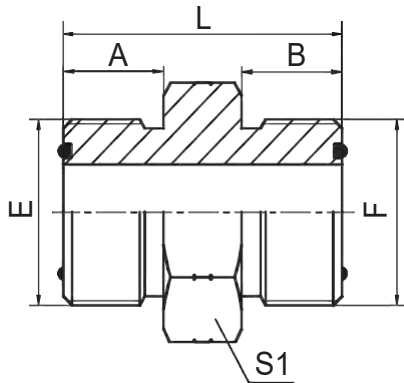

1F

美制ORFS外螺纹O形圈平面密封
ORFS MALE O-RING

| 代号 PART NO. | 螺纹 THREAD | | O形圈 O-RING | | 尺寸 DIMENSIONS | | | | |
|----------------|-------------|-------------|------------|------|---------------|------|------|----|--|
| | E | F | E端 | F端 | A | B | L | S1 | |
| 1F-04 | 9/16"X18 | 9/16"X18 | O011 | O011 | 10 | 10 | 27.5 | 17 | |
| 1F-04-06 | 9/16"X18 | 11/16"X16 | O011 | O012 | 9.8 | 11.2 | 29.7 | 19 | |
| 1F-04-08 | 9/16"X18 | 13/16"X16 | O011 | O014 | 9.8 | 12.8 | 32.5 | 22 | |
| 1F-06 | 11/16"X16 | 11/16"X16 | O012 | O012 | 11.2 | 11.2 | 31.1 | 19 | |
| 1F-06-08 | 11/16"X16 | 13/16"X16 | O012 | O014 | 11.2 | 12.8 | 33.8 | 22 | |
| 1F-06-10 | 11/16"X16 | 1"X14 | O012 | O016 | 11.2 | 15.5 | 38 | 27 | |
| 1F-08 | 13/16"X16 | 13/16"X16 | O014 | O014 | 13 | 13 | 35.4 | 22 | |
| 1F-08-10 | 13/16"X16 | 1"X14 | O014 | O016 | 12.8 | 15.5 | 40 | 27 | |
| 1F-08-12 | 13/16"X16 | 1.3/16"X12 | O014 | O018 | 13 | 17 | 43 | 32 | |
| 1F-10 | 1"X14 | 1"X14 | O016 | O016 | 15.5 | 15.5 | 42.5 | 27 | |
| 1F-10-12 | 1"X14 | 1.3/16"X12 | O016 | O018 | 15.5 | 17 | 45.5 | 32 | |
| 1F-12 | 1.3/16"X12 | 1.3/16"X12 | O018 | O018 | 17 | 17 | 47.1 | 32 | |
| 1F-12-16 | 1.3/16"X12 | 1.7/16"X12 | O018 | O021 | 17 | 17.5 | 45.5 | 38 | |
| 1F-12-20 | 1.3/16"X12 | 1.11/16"X12 | O018 | O025 | 17 | 17.5 | 50.5 | 46 | |
| 1F-16 | 1.7/16"X12 | 1.7/16"X12 | O021 | O021 | 17.5 | 17.5 | 49.3 | 38 | |
| 1F-16-20 | 1.7/16"X12 | 1.11/16"X12 | O021 | O025 | 17.5 | 17.5 | 51.3 | 46 | |
| 1F-16-24 | 1.7/16"X12 | 2"X12 | O021 | O029 | 17.5 | 17.5 | 53 | 55 | |
| 1F-20 | 1.11/16"X12 | 1.11/16"X12 | O025 | O025 | 17.5 | 17.5 | 51.3 | 46 | |
| 1F-20-24 | 1.11/16"X12 | 2"X12 | O025 | O029 | 17.5 | 17.5 | 53 | 55 | |
| 1F-24 | 2"X12 | 2"X12 | O029 | O029 | 17.5 | 17.5 | 53 | 55 | |

美制螺纹O型圈平面密封接头 ORFS Fittings

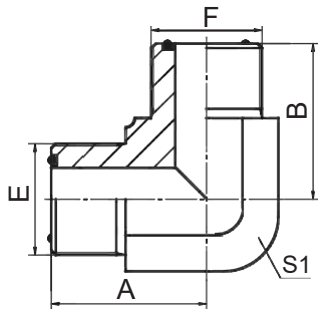

1F9

90° 弯美制ORFS外螺纹O形圈平面密封
90° ELBOW ORFS MALE O-RING

| 代号 PART NO. | 螺 纹 THREAD | | O形圈 O-RING | | 尺 寸 DIMENSIONS | | | |
|----------------|-------------|-------------|------------|------|----------------|------|----|--|
| | E | F | E端 | F端 | A | B | S1 | |
| 1F9-04 | 9/16"X18 | 9/16"X18 | O011 | O011 | 23 | 23 | 14 | |
| 1F9-04-06 | 9/16"X18 | 11/16"X16 | O011 | O012 | 25.5 | 27 | 19 | |
| 1F9-06 | 11/16"X16 | 11/16"X16 | O012 | O012 | 27.5 | 27.5 | 19 | |
| 1F9-06-08 | 11/16"X16 | 13/16"X16 | O012 | O014 | 29 | 31 | 22 | |
| 1F9-08 | 13/16"X16 | 13/16"X16 | O014 | O014 | 31 | 31 | 22 | |
| 1F9-08-12 | 13/16"X16 | 1.3/16"X12 | O014 | O018 | 35.5 | 40.3 | 30 | |
| 1F9-10 | 1"X14 | 1"X14 | O016 | O016 | 36.5 | 36.5 | 27 | |
| 1F9-12 | 1.3/16"X12 | 1.3/16"X12 | O018 | O018 | 41 | 41 | 30 | |
| 1F9-16 | 1.7/16"X12 | 1.7/16"X12 | O021 | O021 | 44.5 | 44.5 | 36 | |
| 1F9-20 | 1.11/16"X12 | 1.11/16"X12 | O025 | O025 | 47.5 | 47.5 | 41 | |
| 1F9-24 | 2"X12 | 2"X12 | O029 | O029 | 53.5 | 53.5 | 50 | |

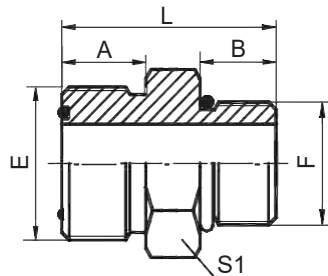

1FH

美制ORFS外螺纹O形圈平面密封 / 公制
外螺纹可调向柱端重系列ISO 6149-2
ORFS MALE O-RING / METIRC MALE
ADJUSTABLE STUD END S-SERIES ISO 6149-2

| 代号 PART NO. | 螺 纹 THREAD | | O形圈 O-RING | | 尺 寸 DIMENSIONS | | | |
|----------------|-------------|---------|------------|-----------|----------------|------|------|----|
| | E | F | E端 | F端 | A | B | L | S1 |
| 1FH-04-10 | 9/16" X18 | M10X1 | O011 | O08.1X1.6 | 9.8 | 9.5 | 28 | 17 |
| 1FH-04-12 | 9/16" X18 | M12X1.5 | O011 | O09.3X2.4 | 9.8 | 11 | 29.5 | 17 |
| 1FH-06-12 | 11/16"X16 | M12X1.5 | O012 | O09.3X2.4 | 11.2 | 11 | 31 | 19 |
| 1FH-06-14 | 11/16"X16 | M14X1.5 | O012 | O11.3X2.4 | 11.2 | 11 | 31 | 19 |
| 1FH-06-16 | 11/16"X16 | M16X1.5 | O012 | O13.3X2.4 | 11.2 | 12.5 | 33.5 | 22 |
| 1FH-08-16 | 13/16"X16 | M16X1.5 | O014 | O13.3X2.4 | 12.8 | 12.5 | 36 | 22 |
| 1FH-08-18 | 13/16"X16 | M18X1.5 | O014 | O15.3X2.4 | 12.8 | 14 | 36.5 | 24 |
| 1FH-08-22 | 13/16"X16 | M22X1.5 | O014 | O19.3X2.4 | 12.8 | 15 | 37.5 | 27 |
| 1FH-10-22 | 1"X14 | M22X1.5 | O016 | O19.3X2.4 | 15.5 | 15 | 40.5 | 27 |
| 1FH-12-22 | 1.3/16"X12 | M22X1.5 | O018 | O19.3X2.4 | 17 | 15 | 45.5 | 32 |
| 1FH-12-27 | 1.3/16"X12 | M27X2 | O018 | O23.5X3.0 | 17 | 18.5 | 49 | 32 |
| 1FH-16-33 | 1.7/16"X12 | M33X2 | O021 | O29.5X3.0 | 17.5 | 18.5 | 51 | 41 |
| 1FH-20-42 | 1.11/16"X12 | M42X2 | O025 | O38.5X3.0 | 17.5 | 19 | 54.5 | 50 |
| 1FH-24-48 | 2"X12 | M48X2 | O029 | O44.5X3.0 | 17.5 | 21.5 | 57 | 55 |

注：F端与ISO 6149-1 油口相配。Note: F end is fit for ISO 6149-1 port.

美制螺纹O型圈平面密封接头 ORFS Fittings

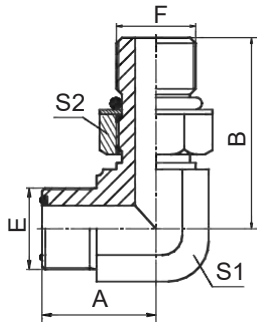

1FH9-OG

90° 弯美制ORFS外螺纹O形圈平面密封 / 公制
外螺纹可调向柱端重系列ISO 6149-2

90° ELBOW ORFS MALE O-RING / METIRC MALE
ADJUSTABLE STUD END S-SERIES ISO6149-2

| 代号 PART NO. | 螺 纹 THREAD | | O形圈 O-RING | | 尺 寸 DIMENSIONS | | | |
|----------------|------------|---------|------------|-----------|----------------|------|----|----|
| | E | F | E端 | F端 | A | B | S1 | S2 |
| 1FH9-04-12OG | 9/16"X18 | M12X1.5 | O011 | O09.3X2.4 | 23 | 32 | 14 | 17 |
| 1FH9-06-14OG | 11/16"X16 | M14X1.5 | O012 | O11.3X2.4 | 27 | 35.5 | 19 | 19 |
| 1FH9-06-16OG | 11/16"X16 | M16X1.5 | O012 | O13.3X2.4 | 27 | 38 | 19 | 22 |
| 1FH9-08-16OG | 13/16"X16 | M16X1.5 | O014 | O13.3X2.4 | 31 | 40.5 | 22 | 22 |
| 1FH9-08-18OG | 13/16"X16 | M18X1.5 | O014 | O15.3X2.4 | 31 | 43 | 22 | 24 |
| 1FH9-08-22OG | 13/16"X16 | M22X1.5 | O014 | O19.3X2.4 | 31 | 44.5 | 22 | 27 |
| 1FH9-10-22OG | 1"X14 | M22X1.5 | O016 | O19.3X2.4 | 36.5 | 48 | 27 | 27 |
| 1FH9-12-27OG | 1.3/16"X12 | M27X2 | O018 | O23.5X3.0 | 40.5 | 50 | 30 | 32 |
| 1FH9-12-33OG | 1.3/16"X12 | M33X2 | O018 | O29.5X3.0 | 42.5 | 56 | 33 | 41 |
| 1FH9-16-33OG | 1.7/16"X12 | M33X2 | O021 | O29.5X3.0 | 44.5 | 58.5 | 36 | 41 |

注：F端与ISO 6149-1油口相配。 Note: F end is fit for ISO 6149-1 port.

美制螺纹O型圈平面密封接头 ORFS Fittings

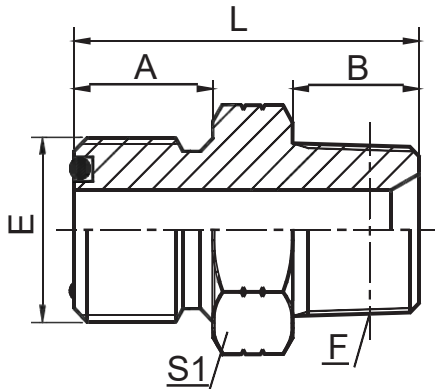

1FN

美制ORFS外螺纹O形圈平面密封 / 布锥管外螺纹
ORFS MALE O-RING / NPT MALE

| 代号 PART NO. | 螺 纹 THREAD | | O形圈 O-RING | | 尺 寸 DIMENSIONS | | | | |
|----------------|-------------|--------------|------------|--|----------------|------|------|----|--|
| | E | F | E端 | | A | B | L | S1 | |
| 1FN-04-02 | 9/16"X18 | Z1/8"X27 | O011 | | 9.8 | 10.5 | 26.5 | 17 | |
| 1FN-04 | 9/16"X18 | Z1/4"X18 | O011 | | 9.8 | 15 | 30.5 | 17 | |
| 1FN-04-06 | 9/16"X18 | Z3/8"X18 | O011 | | 9.8 | 16 | 30.5 | 19 | |
| 1FN-06-04 | 11/16"X16 | Z1/4"X18 | O012 | | 11.2 | 15 | 32 | 19 | |
| 1FN-06 | 11/16"X16 | Z3/8"X18 | O012 | | 11.2 | 16 | 33.5 | 19 | |
| 1FN-06-08 | 11/16"X16 | Z1/2"X14 | O012 | | 11.2 | 19.5 | 39 | 24 | |
| 1FN-08-04 | 13/16"X16 | Z1/4"X18 | O014 | | 12.8 | 15 | 36 | 22 | |
| 1FN-08-06 | 13/16"X16 | Z3/8"X18 | O014 | | 12.8 | 16 | 36.5 | 22 | |
| 1FN-08 | 13/16"X16 | Z1/2"X14 | O014 | | 12.8 | 19.5 | 40 | 24 | |
| 1FN-08-12 | 13/16"X16 | Z3/4"X14 | O014 | | 12.8 | 19.5 | 42.5 | 30 | |
| 1FN-10-08 | 1"X14 | Z1/2"X14 | O016 | | 15.5 | 19.5 | 45 | 27 | |
| 1FN-10-12 | 1"X14 | Z3/4"X14 | O016 | | 15.5 | 19.5 | 45 | 30 | |
| 1FN-12-08 | 1.3/16"X12 | Z1/2"X14 | O018 | | 17 | 19.5 | 46.5 | 32 | |
| 1FN-12 | 1.3/16"X12 | Z3/4"X14 | O018 | | 17 | 19.5 | 47 | 32 | |
| 1FN-12-16 | 1.3/16"X12 | Z1"X11.5 | O018 | | 17 | 25.5 | 53.5 | 36 | |
| 1FN-16-12 | 1.7/16"X12 | Z3/4"X14 | O021 | | 17.5 | 19.5 | 48 | 38 | |
| 1FN-16 | 1.7/16"X12 | Z1"X11.5 | O021 | | 17.5 | 25.5 | 53.5 | 38 | |
| 1FN-16-20 | 1.7/16"X12 | Z1.1/4"X11.5 | O021 | | 17.5 | 26.5 | 57 | 46 | |
| 1FN-20-16 | 1.11/16"X12 | Z1"X11.5 | O025 | | 17.5 | 25.5 | 56 | 46 | |
| 1FN-20 | 1.11/16"X12 | Z1.1/4"X11.5 | O025 | | 17.5 | 26.5 | 56.5 | 46 | |
| 1FN-20-24 | 1.11/16"X12 | Z1.1/2"X11.5 | O025 | | 17.5 | 27.5 | 60 | 50 | |
| 1FN-24 | 2"X12 | Z1.1/2"X11.5 | O029 | | 17.5 | 27.5 | 59.5 | 55 | |

美制螺纹O型圈平面密封接头 ORFS Fittings

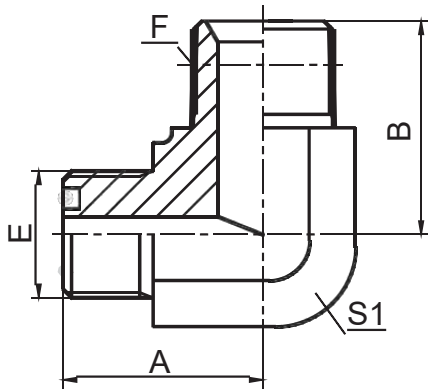

1FN9

90° 弯美制ORFS外螺纹
 O形圈平面密封 / 布锥管外螺纹
 90° ELBOW ORFS MALE
 O-RING / NPT MALE

| 代号 PART NO. | 螺 纹 THREAD | | O形圈 O-RING | | 尺 寸 DIMENSIONS | | | | |
|----------------|-------------|--------------|------------|--|----------------|------|----|--|--|
| | E | F | E端 | | A | B | S1 | | |
| 1FN9-04-02 | 9/16X18 | Z1/8"X27 | O011 | | 23 | 24 | 14 | | |
| 1FN9-04 | 9/16X18 | Z1/4"X18 | O011 | | 23 | 25.5 | 14 | | |
| 1FN9-06-04 | 11/16"X16 | Z1/4"X18 | O012 | | 27 | 28.5 | 19 | | |
| 1FN9-06 | 11/16"X16 | Z3/8"X18 | O012 | | 27.5 | 31 | 19 | | |
| 1FN9-06-08 | 11/16"X16 | Z1/2"X14 | O012 | | 29 | 36.7 | 22 | | |
| 1FN9-08-06 | 13/16"X16 | Z3/8"X18 | O014 | | 31 | 33.5 | 22 | | |
| 1FN9-08 | 13/16"X16 | Z1/2"X14 | O014 | | 31 | 37.3 | 22 | | |
| 1FN9-08-12 | 13/16"X16 | Z3/4"X14 | O014 | | 34.5 | 44 | 27 | | |
| 1FN9-10-08 | 1"X14 | Z1/2"X14 | O016 | | 36.5 | 40 | 27 | | |
| 1FN9-10-12 | 1"X14 | Z3/4"X14 | O016 | | 36.5 | 44 | 27 | | |
| 1FN9-12-08 | 1.3/16"X12 | Z1/2"X14 | O018 | | 40.3 | 41.5 | 30 | | |
| 1FN9-12 | 1.3/16"X12 | Z3/4"X14 | O018 | | 41 | 45.5 | 30 | | |
| 1FN9-12-16 | 1.3/16"X12 | Z1"X11.5 | O018 | | 43 | 50 | 33 | | |
| 1FN9-16-12 | 1.7/16"X12 | Z3/4"X14 | O021 | | 44.5 | 49 | 36 | | |
| 1FN9-16 | 1.7/16"X12 | Z1"X11.5 | O021 | | 44.5 | 51.5 | 36 | | |
| 1FN9-20-16 | 1.11/16"X12 | Z1"X11.5 | O025 | | 47.5 | 54.5 | 41 | | |
| 1FN9-20 | 1.11/16"X12 | Z1.1/4"X11.5 | O025 | | 47.5 | 54.5 | 41 | | |
| 1FN9-24 | 2"X12 | Z1.1/2"X11.5 | O029 | | 53.5 | 61 | 50 | | |

美制螺纹O型圈平面密封接头 ORFS Fittings

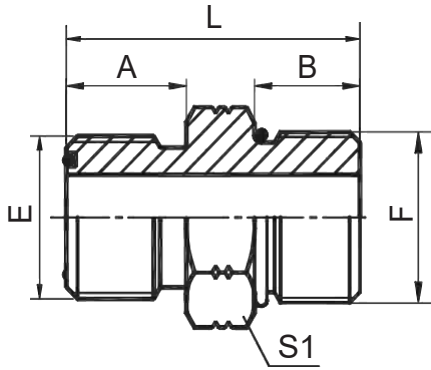

1FO

美制ORFS外螺纹O形圈平面密封 / 美制
SAE外螺纹带O形圈重系列ISO 11926-2
ORFS MALE O-RING /
SAE O-RING BOSS S-SERIES ISO 11926-2

| 代号 PART NO. | 螺纹 THREAD | | O形圈 O-RING | | 尺寸 DIMENSIONS | | | | |
|----------------|-------------|------------|------------|------|---------------|------|------|----|--|
| | E | F | E端 | F端 | A | B | L | S1 | |
| 1FO-04 | 9/16"X18 | 7/16"X20 | O011 | O904 | 9.8 | 11 | 28.7 | 17 | |
| 1FO-04-05 | 9/16"X18 | 1/2"X20 | O011 | O905 | 9.8 | 11 | 28.7 | 17 | |
| 1FO-04-06 | 9/16"X18 | 9/16"X18 | O011 | O906 | 9.8 | 12 | 29.5 | 17 | |
| 1FO-04-08 | 9/16"X18 | 3/4"X16 | O011 | O908 | 9.8 | 14 | 33.5 | 22 | |
| 1FO-06-04 | 11/16"X16 | 7/16"X20 | O012 | O904 | 11.2 | 11 | 33.5 | 19 | |
| 1FO-06-05 | 11/16"X16 | 1/2"X20 | O012 | O905 | 11.2 | 11 | 30.9 | 19 | |
| 1FO-06 | 11/16"X16 | 9/16"X18 | O012 | O906 | 11.2 | 12 | 31.9 | 19 | |
| 1FO-06-08 | 11/16"X16 | 3/4"X16 | O012 | O908 | 11.2 | 14 | 35 | 22 | |
| 1FO-06-10 | 11/16"X16 | 7/8"X14 | O012 | O910 | 11.2 | 16 | 38.5 | 27 | |
| 1FO-08-06 | 13/16"X16 | 9/16"X18 | O014 | O906 | 12.8 | 12 | 34.5 | 22 | |
| 1FO-08 | 13/16"X16 | 3/4"X16 | O014 | O908 | 12.8 | 14 | 36.6 | 22 | |
| 1FO-08-10 | 13/16"X16 | 7/8"X14 | O014 | O910 | 12.8 | 16 | 40.5 | 27 | |
| 1FO-08-12 | 13/16"X16 | 1.1/16"X12 | O014 | O912 | 12.8 | 18.5 | 44.5 | 32 | |
| 1FO-10 | 1"X14 | 7/8"X14 | O016 | O910 | 15.5 | 16 | 43.1 | 27 | |
| 1FO-10-08 | 1"X14 | 3/4"X16 | O016 | O908 | 15.5 | 14 | 44 | 27 | |
| 1FO-10-12 | 1"X14 | 1.1/16"X12 | O016 | O912 | 15.5 | 18.5 | 47 | 32 | |
| 1FO-12-10 | 1.3/16"X12 | 7/8"X14 | O018 | O910 | 17 | 16 | 49 | 32 | |
| 1FO-12 | 1.3/16"X12 | 1.1/16"X12 | O018 | O912 | 17 | 18.5 | 48.6 | 32 | |
| 1FO-12-16 | 1.3/16"X12 | 1.5/16"X12 | O018 | O916 | 17 | 18.5 | 49.8 | 38 | |
| 1FO-16-12 | 1.7/16"X12 | 1.1/16"X12 | O021 | O912 | 17.5 | 18.5 | 53 | 38 | |
| 1FO-16 | 1.7/16"X12 | 1.5/16"X12 | O021 | O916 | 17.5 | 18.5 | 50.3 | 38 | |
| 1FO-16-20 | 1.7/16"X12 | 1.5/8"X12 | O021 | O920 | 17.5 | 18.5 | 52 | 50 | |
| 1FO-20-16 | 1.11/16"X12 | 1.5/16"X12 | O025 | O916 | 17.5 | 18.5 | 54 | 46 | |
| 1FO-20 | 1.11/16"X12 | 1.5/8"X12 | O025 | O920 | 17.5 | 18.5 | 52.3 | 50 | |
| 1FO-24-20 | 2"X12 | 1.5/8"X12 | O029 | O920 | 17.5 | 18.5 | 58 | 55 | |
| 1FO-24 | 2"X12 | 1.7/8"X12 | O029 | O924 | 17.5 | 18.5 | 54.1 | 55 | |

注： F端与ISO 11926-1 油口相配。

Note : F end is connected with ISO 11926-1 port.

美制螺纹O型圈平面密封接头 ORFS Fittings

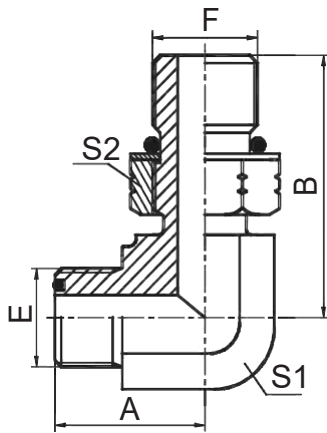

1FO9-OG

90° 弯美制ORFS外螺纹O形圈平面密封 / 美制
SAE外螺纹带O形圈重系列ISO 11926-2
90° ELBOW ORFS MALE O-RING / SAE O-RING
BOSS S-SERIES ISO 11926-2

| 代号 PART NO. | 螺纹 THREAD | | O形圈 O-RING | | 尺寸 DIMENSIONS | | | | |
|----------------|-------------|------------|------------|------|---------------|------|----|----|--|
| | E | F | E端 | F端 | A | B | S1 | S2 | |
| 1FO9-04OG | 9/16"X18 | 7/16"X20 | O011 | O904 | 23 | 30.3 | 14 | 17 | |
| 1FO9-04-06OG | 9/16"X18 | 9/16"X18 | O011 | O906 | 23 | 32 | 14 | 19 | |
| 1FO9-06-04OG | 11/16"X16 | 7/16"X20 | O012 | O904 | 27.5 | 33.5 | 19 | 17 | |
| 1FO9-06OG | 11/16"X16 | 9/16"X18 | O012 | O906 | 27.5 | 34.5 | 19 | 19 | |
| 1FO9-06-08OG | 11/16"X16 | 3/4"X16 | O012 | O908 | 27.5 | 38 | 19 | 24 | |
| 1FO9-06-10OG | 11/16"X16 | 7/8"X14 | O012 | O910 | 29 | 45.3 | 22 | 27 | |
| 1FO9-08-06OG | 13/16"X16 | 9/16"X18 | O014 | O906 | 31 | 37 | 22 | 19 | |
| 1FO9-08OG | 13/16"X16 | 3/4"X16 | O014 | O908 | 31 | 40.5 | 22 | 24 | |
| 1FO9-08-10OG | 13/16"X16 | 7/8"X14 | O014 | O910 | 31 | 45.3 | 22 | 27 | |
| 1FO9-08-12OG | 13/16"X16 | 1.1/16"X12 | O014 | O912 | 34.5 | 52 | 27 | 32 | |
| 1FO9-10-08OG | 1"X14 | 3/4"X16 | O016 | O908 | 36.5 | 45 | 27 | 24 | |
| 1FO9-10OG | 1"X14 | 7/8"X14 | O016 | O910 | 36.5 | 50.8 | 27 | 27 | |
| 1FO9-10-12OG | 1"X14 | 1.1/16"X12 | O016 | O912 | 36.5 | 52 | 27 | 32 | |
| 1FO9-12-10OG | 1.3/16"X12 | 7/8"X14 | O018 | O910 | 41 | 52.8 | 30 | 27 | |
| 1FO9-12OG | 1.3/16"X12 | 1.1/16"X12 | O018 | O912 | 41 | 54 | 30 | 32 | |
| 1FO9-12-16OG | 1.3/16"X12 | 1.5/16"X12 | O018 | O916 | 43 | 55.5 | 33 | 41 | |
| 1FO9-16-12OG | 1.7/16"X12 | 1.1/16"X12 | O021 | O912 | 44.5 | 59 | 36 | 32 | |
| 1FO9-16OG | 1.7/16"X12 | 1.5/16"X12 | O021 | O916 | 44.5 | 59 | 36 | 41 | |
| 1FO9-20OG | 1.11/16"X12 | 1.5/8"X12 | O025 | O920 | 47.5 | 60.5 | 41 | 50 | |
| 1FO9-20-24OG | 1.11/16"X12 | 1.7/8"X12 | O025 | O924 | 51.5 | 66.5 | 48 | 55 | |
| 1FO9-24-20OG | 2"X12 | 1.5/8"X12 | O029 | O920 | 53.5 | 67.5 | 50 | 50 | |
| 1FO9-24OG | 2"X12 | 1.7/8"X12 | O029 | O924 | 52 | 66.5 | 48 | 55 | |

注：F端与ISO 11926-1 油口相配。

Note : F end is connected with ISO 11926-1 port.

美制螺纹O型圈平面密封接头 ORFS Fittings

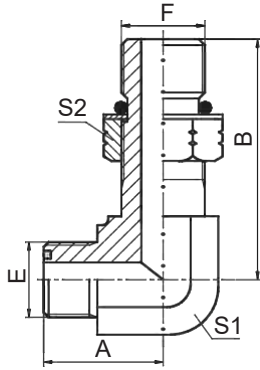

1FO9-OGL

90° 弯美制ORFS外螺纹O形圈平面密封 / 长美制SAE外螺纹带O形圈重系列ISO 11926-2
 90° ELBOW ORFS MALE O-RING /
 LONG SAE O-RING BOSS S-SERIES ISO 11926-2

| 代号 PART NO. | 螺 纹 THREAD | | O形圈 O-RING | | 尺 寸 DIMENSIONS | | | | |
|----------------|---------------|------------|---------------|------|-------------------|------|----|----|--|
| | E | F | E端 | F端 | A | B | S1 | S2 | |
| 1FO9-04OGL | 9/16"X18 | 7/16"X20 | O011 | O904 | 23 | 44 | 14 | 17 | |
| 1FO9-04-08OGL | 9/16"X18 | 3/4"X16 | O011 | O908 | 25.5 | 63.5 | 19 | 24 | |
| 1FO9-06OGL | 11/16"X16 | 9/16"X18 | O012 | O906 | 27.5 | 52.8 | 19 | 19 | |
| 1FO9-06-08OGL | 11/16"X16 | 3/4"X16 | O012 | O908 | 27.5 | 63.5 | 19 | 24 | |
| 1FO9-08OGL | 13/16"X16 | 3/4"X16 | O014 | O908 | 31 | 63.5 | 22 | 24 | |
| 1FO9-08-10OGL | 13/16"X16 | 7/8"X14 | O014 | O910 | 31 | 73.4 | 22 | 27 | |
| 1FO9-10OGL | 1"X14 | 7/8"X14 | O016 | O910 | 36.5 | 73.4 | 27 | 27 | |
| 1FO9-12OGL | 1.3/16"X12 | 1.1/16"X12 | O018 | O912 | 41 | 84.8 | 30 | 32 | |
| 1FO9-12-16OGL | 1.3/16"X12 | 1.5/16"X12 | O018 | O916 | 43 | 94.5 | 33 | 41 | |
| 1FO9-16OGL | 1.7/16"X12 | 1.5/16"X12 | O021 | O916 | 44.5 | 94.5 | 36 | 41 | |

美制螺纹O型圈平面密封接头 ORFS Fittings

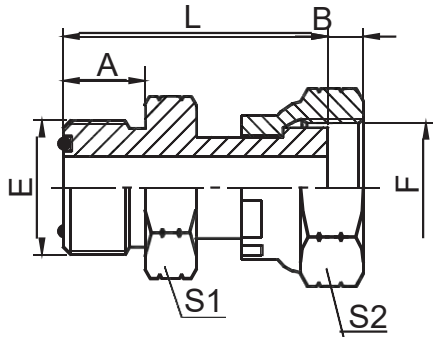

2F

美制ORFS外螺纹O形
圈平面密封 / ORFS内螺纹
ORFS MALE
O-RING / ORFS FEMALE

| 代号 PART NO. | 螺 纹 THREAD | | O形圈 O-RING | | 尺 寸 DIMENSIONS | | | | |
|----------------|-------------|-------------|------------|--|----------------|------|------|----|----|
| | E | F | E端 | | A | B | L | S1 | S2 |
| 2F-04 | 9/16"X18 | 9/16"X18 | O011 | | 9.8 | 8.5 | 33 | 17 | 19 |
| 2F-04-06 | 9/16"X18 | 11/16"X16 | O011 | | 9.8 | 10 | 34.5 | 17 | 22 |
| 2F-04-08 | 9/16"X18 | 13/16"X16 | O011 | | 9.8 | 11 | 36.5 | 19 | 27 |
| 2F-06-04 | 11/16"X16 | 9/16"X18 | O012 | | 11.2 | 8.5 | 35.5 | 19 | 19 |
| 2F-06 | 11/16"X16 | 11/16"X16 | O012 | | 11.2 | 10 | 38.5 | 19 | 22 |
| 2F-06-08 | 11/16"X16 | 13/16"X16 | O012 | | 11.2 | 11 | 37.7 | 19 | 27 |
| 2F-06-10 | 11/16"X16 | 1"X14 | O012 | | 11.2 | 13.5 | 43.7 | 24 | 30 |
| 2F-08-06 | 13/16"X16 | 11/16"X16 | O014 | | 13 | 10 | 41 | 22 | 22 |
| 2F-08 | 13/16"X16 | 13/16"X16 | O014 | | 13 | 11 | 43 | 22 | 27 |
| 2F-08-10 | 13/16"X16 | 1"X14 | O014 | | 13 | 13.5 | 45.5 | 24 | 30 |
| 2F-08-12 | 13/16"X16 | 1.3/16"X12 | O014 | | 13 | 15 | 49 | 30 | 36 |
| 2F-10-08 | 1"X14 | 13/16"X16 | O016 | | 15.5 | 11 | 47.5 | 27 | 27 |
| 2F-10 | 1"X14 | 1"X14 | O016 | | 15.5 | 13.5 | 51.5 | 27 | 30 |
| 2F-10-12 | 1"X14 | 1.3/16"X12 | O016 | | 15.5 | 15 | 51.5 | 30 | 36 |
| 2F-10-16 | 1"X14 | 1.7/16"X12 | O016 | | 15.5 | 15 | 56 | 36 | 41 |
| 2F-12-08 | 1.3/16"X12 | 13/16"X16 | O018 | | 17 | 11 | 50.5 | 32 | 27 |
| 2F-12-10 | 1.3/16"X12 | 1"X14 | O018 | | 17 | 13.5 | 54.5 | 32 | 30 |
| 2F-12 | 1.3/16"X12 | 1.3/16"X12 | O018 | | 17 | 15 | 56 | 32 | 36 |
| 2F-12-16 | 1.3/16"X12 | 1.7/16"X12 | O018 | | 17 | 15 | 58 | 36 | 41 |
| 2F-16-12 | 1.7/16"X12 | 1.3/16"X12 | O021 | | 17.5 | 15 | 58 | 38 | 36 |
| 2F-16 | 1.7/16"X12 | 1.7/16"X12 | O021 | | 17.5 | 15 | 60 | 38 | 41 |
| 2F-16-20 | 1.7/16"X12 | 1.11/16"X12 | O021 | | 17.5 | 15 | 62 | 41 | 50 |
| 2F-20-16 | 1.11/16"X12 | 1.7/16"X12 | O025 | | 17.5 | 15 | 58.5 | 46 | 41 |
| 2F-20 | 1.11/16"X12 | 1.11/16"X12 | O025 | | 17.5 | 15 | 62 | 46 | 50 |
| 2F-20-24 | 1.11/16"X12 | 2"X12 | O025 | | 17.5 | 16 | 65.5 | 50 | 60 |
| 2F-24-20 | 2"X12 | 1.11/16"X12 | O029 | | 17.5 | 15 | 64 | 55 | 50 |
| 2F-24 | 2"X12 | 2"X12 | O029 | | 17.5 | 16 | 64 | 55 | 60 |

美制螺纹O型圈平面密封接头 ORFS Fittings

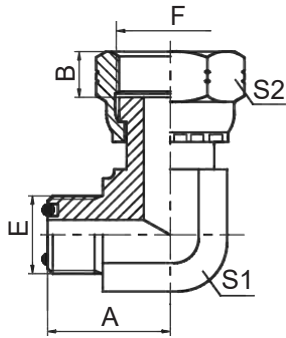

2F9

90° 弯美制ORFS外螺纹
O形圈平面密封 / ORFS内螺纹
90° ELBOW ORFS MALE
O-RING / ORFS FEMALE

| 代号 PART NO. | 螺 纹 THREAD | | O形圈 O-RING | | 尺 寸 DIMENSIONS | | | | |
|----------------|-------------|-------------|------------|--|----------------|-----|----|----|--|
| | E | F | E端 | | A | B | S1 | S2 | |
| 2F9-04 | 9/16X18 | 9/16X18 | O011 | | 23 | 8.5 | 14 | 19 | |
| 2F9-04-06 | 9/16X18 | 11/16"X16 | O011 | | 23 | 10 | 14 | 22 | |
| 2F9-06-04 | 11/16"X16 | 9/16X18 | O012 | | 27.5 | 8.5 | 19 | 19 | |
| 2F9-06 | 11/16"X16 | 11/16"X16 | O012 | | 27.5 | 10 | 19 | 22 | |
| 2F9-06-08 | 11/16"X16 | 13/16"X16 | O012 | | 27 | 11 | 19 | 27 | |
| 2F9-08-06 | 13/16"X16 | 11/16"X16 | O014 | | 31 | 10 | 22 | 22 | |
| 2F9-08 | 13/16"X16 | 13/16"X16 | O014 | | 31 | 11 | 22 | 27 | |
| 2F9-10-08 | 1"X14 | 13/16"X16 | O016 | | 36.5 | 11 | 27 | 27 | |
| 2F9-10 | 1"X14 | 1"X14 | O016 | | 36.5 | 15 | 27 | 30 | |
| 2F9-10-12 | 1"X14 | 1.3/16"X12 | O016 | | 36.5 | 15 | 27 | 36 | |
| 2F9-12 | 1.3/16"X12 | 1.3/16"X12 | O018 | | 41 | 15 | 30 | 36 | |
| 2F9-12-16 | 1.3/16"X12 | 1.7/16"X12 | O018 | | 42.5 | 15 | 33 | 41 | |
| 2F9-16-12 | 1.7/16"X12 | 1.3/16"X12 | O021 | | 44.5 | 15 | 36 | 36 | |
| 2F9-16 | 1.7/16"X12 | 1.7/16"X12 | O021 | | 44.5 | 15 | 36 | 41 | |
| 2F9-20 | 1.11/16"X12 | 1.11/16"X12 | O025 | | 44.5 | 15 | 41 | 50 | |
| 2F9-24 | 2"X12 | 2"X12 | O029 | | 53.5 | 15 | 50 | 60 | |

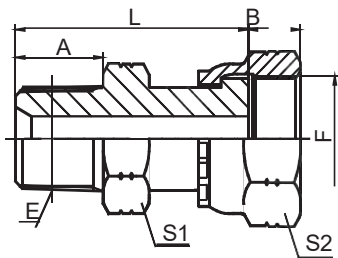

2NF

美制布锥管外螺纹 / ORFS内螺纹
NPT MALE / ORFS FEMALE

| 代号 PART NO. | 螺 纹 THREAD | | | | 尺 寸 DIMENSIONS | | | | |
|----------------|--------------|-------------|--|--|----------------|-----|------|----|----|
| | E | F | | | A | B | L | S1 | S2 |
| 2NF-02-04 | Z1/8"X27 | 9/16"X18 | | | 10.5 | 8.5 | 32 | 14 | 19 |
| 2NF-04 | Z1/4"X18 | 9/16"X18 | | | 15 | 8.5 | 36.5 | 17 | 19 |
| 2NF-04-06 | Z1/4"X18 | 11/16"X16 | | | 15 | 10 | 39.5 | 17 | 22 |
| 2NF-06 | Z3/8"X18 | 11/16"X16 | | | 16 | 10 | 40.5 | 19 | 22 |
| 2NF-06-08 | Z3/8"X18 | 13/16"X16 | | | 16 | 11 | 42.5 | 19 | 27 |
| 2NF-08 | Z1/2"X14 | 13/16"X16 | | | 19.5 | 11 | 48 | 22 | 27 |
| 2NF-08-10 | Z1/2"X14 | 1"X14 | | | 19.5 | 13 | 52 | 24 | 30 |
| 2NF-12 | Z3/4"X14 | 1.3/16"X12 | | | 19.5 | 15 | 55.5 | 30 | 36 |
| 2NF-12-16 | Z3/4"X14 | 1.7/16"X12 | | | 19.5 | 15 | 58.5 | 36 | 41 |
| 2NF-16 | Z1"X11.5 | 1.7/16"X12 | | | 25.5 | 15 | 64.5 | 36 | 41 |
| 2NF-16-20 | Z1"X11.5 | 1.11/16"X12 | | | 25.5 | 15 | 70 | 41 | 50 |
| 2NF-20 | Z1.1/4"X11.5 | 1.11/16"X12 | | | 26.5 | 15 | 70 | 46 | 50 |
| 2NF-24 | Z1.1/2"X11.5 | 2"X12 | | | 27.5 | 15 | 74 | 50 | 60 |

美制螺纹O型圈平面密封接头 ORFS Fittings

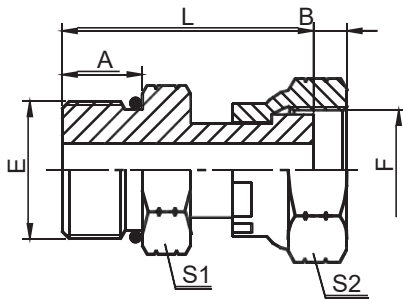

2OF

美制SAE外螺纹带O形圈
重系列ISO 11926-2 / ORFS内螺纹
SAE O-RING BOSS
S-SERIES ISO 11926-2 / ORFS FEMALE

| 代号 PART NO. | 螺 纹 THREAD | | O形圈 O-RING | | 尺 寸 DIMENSIONS | | | | |
|----------------|------------|-------------|------------|--|----------------|------|------|----|----|
| | E | F | E端 | | A | B | L | S1 | S2 |
| 2OF-04 | 7/16"X20 | 9/16"X18 | O904 | | 11 | 8.5 | 32.5 | 17 | 19 |
| 2OF-04-06 | 7/16"X20 | 11/16"X16 | O904 | | 11 | 10 | 35.5 | 17 | 22 |
| 2OF-06-04 | 9/16"X18 | 9/16"X18 | O906 | | 12 | 8.5 | 33.5 | 17 | 19 |
| 2OF-06 | 9/16"X18 | 11/16"X16 | O906 | | 12 | 10 | 36.5 | 19 | 22 |
| 2OF-06-08 | 9/16"X18 | 13/16"X16 | O906 | | 12 | 11 | 38.5 | 19 | 27 |
| 2OF-08-06 | 3/4"X16 | 11/16"X16 | O908 | | 14 | 10 | 40.5 | 22 | 22 |
| 2OF-08 | 3/4"X16 | 13/16"X16 | O908 | | 14 | 11 | 42.5 | 22 | 27 |
| 2OF-10-08 | 7/8"X14 | 13/16"X16 | O910 | | 16 | 11 | 46.5 | 27 | 27 |
| 2OF-10 | 7/8"X14 | 1"X14 | O910 | | 16 | 13.5 | 50.5 | 27 | 30 |
| 2OF-12-10 | 1.1/16"X12 | 1"X14 | O912 | | 18.5 | 13.5 | 54 | 32 | 30 |
| 2OF-12 | 1.1/16"X12 | 1.3/16"X12 | O912 | | 18.5 | 15 | 56 | 32 | 36 |
| 2OF-16-12 | 1.5/16"X12 | 1.3/16"X12 | O916 | | 18.5 | 15 | 55.5 | 38 | 36 |
| 2OF-16 | 1.5/16"X12 | 1.7/16"X12 | O916 | | 18.5 | 15 | 57.5 | 38 | 41 |
| 2OF-20-16 | 1.5/8"X12 | 1.7/16"X12 | O920 | | 18.5 | 15 | 61.5 | 50 | 41 |
| 2OF-20 | 1.5/8"X12 | 1.11/16"X12 | O920 | | 18.5 | 15 | 65 | 50 | 50 |
| 2OF-24 | 2"X12 | 1.7/8"X12 | O924 | | 18.5 | 16 | 65 | 55 | 60 |

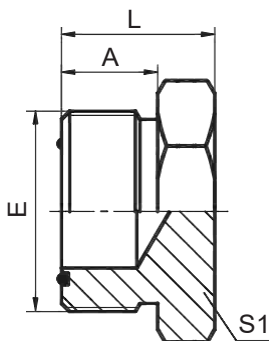

4F

美制ORFS外螺纹O形圈平面密封堵头
ORFS MALE O-RING PLUG

| 代号 PART NO. | 螺 纹 THREAD | | O形圈 O-RING | | 尺 寸 DIMENSIONS | | | | |
|----------------|-------------|--|------------|--|----------------|------|----|--|--|
| | E | | E端 | | A | L | S1 | | |
| 4F-04 | 9/16"X18 | | O011 | | 9.8 | 16.8 | 17 | | |
| 4F-06 | 11/16"X16 | | O012 | | 11.2 | 19.2 | 19 | | |
| 4F-08 | 13/16"X16 | | O014 | | 12.8 | 21.8 | 22 | | |
| 4F-10 | 1"X14 | | O016 | | 15.5 | 25.9 | 27 | | |
| 4F-12 | 1.3/16"X12 | | O018 | | 17 | 27.4 | 32 | | |
| 4F-16 | 1.7/16"X12 | | O021 | | 17.5 | 27.9 | 38 | | |
| 4F-20 | 1.11/16"X12 | | O025 | | 17.5 | 27.9 | 46 | | |
| 4F-24 | 2"X12 | | O029 | | 17.5 | 27.9 | 55 | | |

美制螺纹O型圈平面密封接头 ORFS Fittings

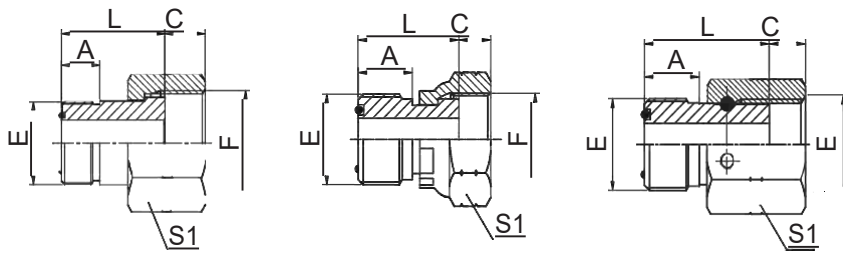

5F-S

ORFS外螺纹 / ORFS内螺纹
ORFS MALE / ORFS FEMALE

| 代号 PART NO. | 螺纹 THREAD | | O形圈 O-RING | | 尺寸 DIMENSIONS | | | | |
|----------------|--------------|-------------|---------------|--|------------------|------|------|----|------|
| | E | F | E端 | | A | C | L | S1 | Fig. |
| 5F-04S | 9/16"X18 | 9/16"X18 | O011 | | 9.8 | 8.5 | 18.5 | 19 | B |
| 5F-04-06S | 9/16"X18 | 11/16"X16 | O011 | | 9.8 | 10 | 19.6 | 22 | B |
| 5F-04-08S | 9/16"X18 | 13/16"X16 | O011 | | 9.8 | 11 | 21.5 | 27 | A |
| 5F-04-10S | 9/16"X18 | 1"X14 | O011 | | 9.8 | 13.5 | 23 | 30 | A |
| 5F-04-12S | 9/16"X18 | 1.3/16"X12 | O011 | | 9.8 | 15 | 24 | 36 | A |
| 5F-04-16S | 9/16"X18 | 1.7/16"X12 | O011 | | 9.8 | 14.8 | 25 | 36 | A |
| 5F-04-20S | 9/16"X18 | 1.11/16"X12 | O011 | | 9.8 | 15 | 25 | 50 | A |
| 5F-06S | 11/16"X16 | 11/16"X16 | O012 | | 11.2 | 10 | 22 | 22 | B |
| 5F-06-04S | 11/16"X16 | 9/16"X18 | O012 | | 11.2 | 8.5 | 20 | 19 | B |
| 5F-06-08S | 11/16"X16 | 13/16"X16 | O012 | | 11.2 | 11 | 22.4 | 27 | B |
| 5F-06-10S | 11/16"X16 | 1"X14 | O012 | | 11.2 | 13.5 | 24.5 | 30 | A |
| 5F-06-12S | 11/16"X16 | 1.3/16"X12 | O012 | | 11.2 | 15 | 25 | 36 | A |
| 5F-06-16S | 11/16"X16 | 1.7/16"X12 | O012 | | 11.2 | 14.8 | 26.5 | 41 | A |
| 5F-06-20S | 11/16"X16 | 1.11/16"X12 | O012 | | 11.2 | 15 | 26.5 | 50 | A |
| 5F-08S | 13/16"X16 | 13/16"X16 | O014 | | 12.8 | 11 | 24 | 27 | B |
| 5F-08-04S | 13/16"X16 | 9/16"X18 | O014 | | 12.8 | 8.5 | 22 | 19 | B |
| 5F-08-06S | 13/16"X16 | 11/16"X16 | O014 | | 12.8 | 10 | 24 | 22 | B |
| 5F-08-10S | 13/16"X16 | 1"X14 | O014 | | 12.8 | 13.5 | 25.7 | 30 | B |
| 5F-08-12S | 13/16"X16 | 1.3/16"X12 | O014 | | 12.8 | 15 | 27.7 | 36 | A |
| 5F-08-16S | 13/16"X16 | 1.7/16"X12 | O014 | | 12.8 | 14.8 | 29.2 | 41 | A |
| 5F-08-20S | 13/16"X16 | 1.11/16"X12 | O014 | | 12.8 | 15 | 29.2 | 50 | A |
| 5F-10S | 1"X14 | 1"X14 | O016 | | 15.5 | 13.5 | 28 | 30 | A |
| 5F-10-06S | 1"X14 | 11/16"X16 | O016 | | 15.5 | 10 | 26.5 | 22 | A |
| 5F-10-08S | 1"X14 | 13/16"X16 | O016 | | 15.5 | 11 | 26.5 | 27 | A |
| 5F-10-12S | 1"X14 | 1.3/16"X12 | O016 | | 15.5 | 15 | 29.5 | 36 | A |
| 5F-10-16S | 1"X14 | 1.7/16"X12 | O016 | | 15.5 | 14.8 | 30.5 | 41 | B |
| 5F-10-20S | 1"X14 | 1.11/16"X12 | O016 | | 15.5 | 15 | 31 | 50 | B |
| 5F-12S | 1.3/16"X12 | 1.3/16"X12 | O018 | | 17 | 15 | 30 | 36 | A |
| 5F-12-06S | 1.3/16"X12 | 11/16"X16 | O018 | | 17 | 10 | 28 | 22 | A |
| 5F-12-08S | 1.3/16"X12 | 13/16"X16 | O018 | | 17 | 11 | 28 | 27 | A |
| 5F-12-10S | 1.3/16"X12 | 1"X14 | O018 | | 17 | 13.5 | 29.5 | 30 | A |
| 5F-12-16S | 1.3/16"X12 | 1.7/16"X12 | O018 | | 17 | 14.8 | 31 | 41 | A |
| 5F-12-20S | 1.3/16"X12 | 1.11/16"X12 | O018 | | 17 | 15 | 32.5 | 50 | B |
| 5F-12-24S | 1.3/16"X12 | 2"X12 | O018 | | 17 | 14.8 | 33.5 | 60 | B |
| 5F-16S | 1.7/16"X12 | 1.7/16"X12 | O021 | | 17.5 | 14.8 | 31.5 | 41 | A |
| 5F-16-04S | 1.7/16"X12 | 9/16"X18 | O021 | | 17.5 | 8.5 | 27 | 19 | A |
| 5F-16-06S | 1.7/16"X12 | 11/16"X16 | O021 | | 17.5 | 10 | 28.5 | 22 | A |
| 5F-16-08S | 1.7/16"X12 | 13/16"X16 | O021 | | 17.5 | 11 | 29 | 27 | A |
| 5F-16-10S | 1.7/16"X12 | 1"X14 | O021 | | 17.5 | 13.5 | 30 | 30 | A |
| 5F-16-12S | 1.7/16"X12 | 1.3/16"X12 | O021 | | 17.5 | 15 | 31 | 36 | A |
| 5F-16-20S | 1.7/16"X12 | 1.11/16"X12 | O021 | | 17.5 | 15 | 34.5 | 50 | C |
| 5F-16-24S | 1.7/16"X12 | 2"X12 | O021 | | 17.5 | 14.8 | 34 | 60 | A |
| 5F-20S | 1.11/16"X12 | 1.11/16"X12 | O025 | | 17.5 | 15 | 34.5 | 50 | C |
| 5F-20-12S | 1.11/16"X12 | 1.3/16"X12 | O025 | | 17.5 | 15 | 30.5 | 36 | B |
| 5F-20-16S | 1.11/16"X12 | 1.7/16"X12 | O025 | | 17.5 | 14.8 | 32 | 41 | B |
| 5F-20-24S | 1.11/16"X12 | 2"X12 | O025 | | 17.5 | 14.8 | 34 | 60 | A |
| 5F-24S | 2"X12 | 1.11/16"X12 | O029 | | 17.5 | 14.8 | 36.5 | 60 | C |
| 5F-24-20S | 2"X12 | 1.11/16"X12 | O029 | | 17.5 | 15 | 35.5 | 50 | C |

美制螺纹O型圈平面密封接头 ORFS Fittings

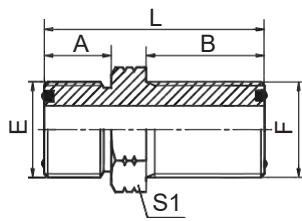

6F

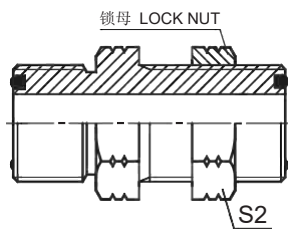

6F-LN

6F

美制ORFS外螺纹
O形圈平面密封过板接头
ORFS MALE O-RING BULKHEAD

| 代号 PART NO. | 螺 纹 THREAD | | O形圈 O-RING | | 尺 寸 DIMENSIONS | | | | |
|----------------|-------------|-------------|------------|------|----------------|------|------|----|----|
| | E | F | E端 | F端 | A | B | L | S1 | S2 |
| 6F-04 | 9/16"X18 | 9/16"X18 | O011 | O011 | 9.8 | 31.5 | 48.2 | 22 | 22 |
| 6F-06 | 11/16"X16 | 11/16"X16 | O012 | O012 | 11.2 | 34 | 53.2 | 27 | 27 |
| 6F-08 | 13/16"X16 | 13/16"X16 | O014 | O014 | 12.8 | 36.5 | 58.3 | 30 | 30 |
| 6F-10 | 1"X14 | 1"X14 | O016 | O016 | 15.5 | 40.6 | 66.6 | 36 | 36 |
| 6F-12 | 1.3/16"X12 | 1.3/16"X12 | O018 | O018 | 17 | 41.7 | 69.2 | 38 | 38 |
| 6F-16 | 1.7/16"X12 | 1.7/16"X12 | O021 | O021 | 17.5 | 42.2 | 70.2 | 46 | 46 |
| 6F-20 | 1.11/16"X12 | 1.11/16"X12 | O025 | O025 | 17.5 | 42.2 | 70.2 | 50 | 50 |
| 6F-24 | 2"X12 | 2"X12 | O029 | O029 | 17.5 | 42.2 | 70.2 | 60 | 60 |

注：如需带锁母订货，则请在代号后加“LN”，如6F-16LN，锁母代号为8F。Note: In case if you are interested to order the adapter with lock nut, please insert suffix "LN" after our part no., for example 6F-16LN, The lock nut no. is 8F.

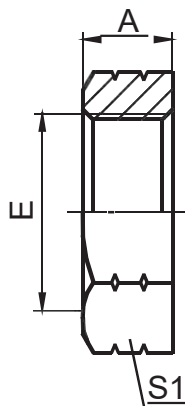

8F

美制ORFS螺纹锁母
ORFS LOCK NUT

| 代号 PART NO. | 螺 纹 THREAD | | 尺 寸 DIMENSIONS | | | | |
|----------------|-------------|--|----------------|----|--|--|--|
| | E | | A | S1 | | | |
| 8F-04 | 9/16"X18 | | 7 | 22 | | | |
| 8F-06 | 11/16"X16 | | 8 | 27 | | | |
| 8F-08 | 13/16"X16 | | 9 | 30 | | | |
| 8F-10 | 1"X14 | | 10.4 | 36 | | | |
| 8F-12 | 1.3/16"X12 | | 10.4 | 38 | | | |
| 8F-16 | 1.7/16"X12 | | 10.4 | 46 | | | |
| 8F-20 | 1.11/16"X12 | | 10.4 | 50 | | | |
| 8F-24 | 2"X12 | | 10.4 | 60 | | | |

注：8F-04与8J-06同。Note: 8F-04 is the same as 8J-06.

美制螺纹O型圈平面密封接头 ORFS Fittings

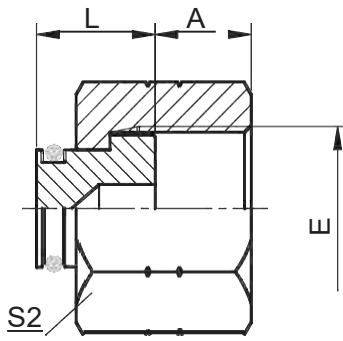

9F

美制ORFS内螺纹平面堵头
ORFS FEMALE FLAT PLUG

| 代号 PART NO. | 螺 纹 THREAD | | | 尺 寸 DIMENSIONS | | | | |
|----------------|-------------|--|--|----------------|------|----|--|--|
| | E | | | A | L | S2 | | |
| 9F-04 | 9/16"X18 | | | 8.5 | 10.5 | 19 | | |
| 9F-06 | 11/16"X16 | | | 10 | 13 | 22 | | |
| 9F-08 | 13/16"X16 | | | 11 | 14 | 27 | | |
| 9F-10 | 1"X14 | | | 13.5 | 16 | 30 | | |
| 9F-12 | 1.3/16"X12 | | | 15 | 15 | 36 | | |
| 9F-16 | 1.7/16"X12 | | | 15 | 18 | 41 | | |
| 9F-20 | 1.11/16"X12 | | | 15 | 19 | 50 | | |
| 9F-24 | 2"X12 | | | 16 | 21 | 60 | | |

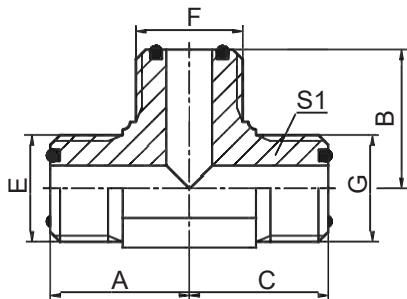

AF

美制ORFS外螺纹O形圈平面密封三通
ORFS MALE O-RING TEE

| 代号 PART NO. | 螺 纹 THREAD | | | O形圈 O-RING | | | 尺 寸 DIMENSIONS | | | | |
|----------------|-------------|-------------|-------------|------------|------|------|----------------|------|------|----|--|
| | E | F | G | E端 | F端 | G端 | A | B | C | S1 | |
| AF-04 | 9/16"X18 | 9/16"X18 | 9/16"X18 | O011 | O011 | O011 | 23 | 23 | 23 | 14 | |
| AF-06 | 11/16"X16 | 11/16"X16 | 11/16"X16 | O012 | O012 | O012 | 27 | 27 | 27 | 19 | |
| AF-08 | 13/16"X16 | 13/16"X16 | 13/16"X16 | O014 | O014 | O014 | 31 | 31 | 31 | 22 | |
| AF-10 | 1"X14 | 1"X14 | 1"X14 | O016 | O016 | O016 | 36.5 | 36.5 | 36.5 | 27 | |
| AF-12 | 1.3/16"X12 | 1.3/16"X12 | 1.3/16"X12 | O018 | O018 | O018 | 40.3 | 40.3 | 40.3 | 30 | |
| AF-16 | 1.7/16"X12 | 1.7/16"X12 | 1.7/16"X12 | O021 | O021 | O021 | 44.5 | 44.5 | 44.5 | 36 | |
| AF-20 | 1.11/16"X12 | 1.11/16"X12 | 1.11/16"X12 | O025 | O025 | O025 | 47.5 | 47.5 | 47.5 | 41 | |
| AF-24 | 2"X12 | 2"X12 | 2"X12 | O029 | O029 | O029 | 53.5 | 53.5 | 53.5 | 50 | |

美制螺纹O型圈平面密封接头 ORFS Fittings

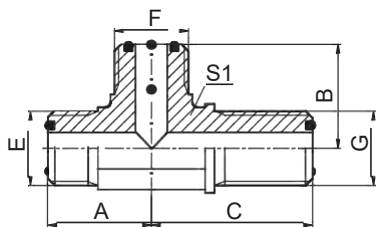

AFF6F

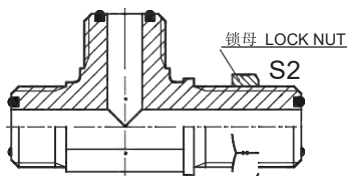

AFF6F-LN

美制ORFS外螺纹
O形圈平面密封过板接头三通
ORFS MALE O-RING
BULKHEAD RUN TEE

| 代号 PART NO. | 螺 纹 THREAD | | | O形圈 O-RING | | | 尺 寸 DIMENSIONS | | | | |
|----------------|-------------|-------------|-------------|------------|------|------|----------------|------|----|----|----|
| | E | F | G | E端 | F端 | G端 | A | B | C | S1 | S2 |
| AFF6F-04 | 9/16"X18 | 9/16"X18 | 9/16"X18 | O011 | O011 | O011 | 23 | 23 | 47 | 14 | 22 |
| AFF6F-06 | 11/16"X16 | 11/16"X16 | 11/16"X16 | O012 | O012 | O012 | 27 | 27 | 52 | 19 | 27 |
| AFF6F-08 | 13/16"X16 | 13/16"X16 | 13/16"X16 | O014 | O014 | O014 | 31 | 31 | 56 | 22 | 30 |
| AFF6F-10 | 1"X14 | 1"X14 | 1"X14 | O016 | O016 | O016 | 36.5 | 36.5 | 63 | 27 | 36 |
| AFF6F-12 | 1.3/16"X12 | 1.3/16"X12 | 1.3/16"X12 | O018 | O018 | O018 | 41 | 41 | 67 | 30 | 41 |
| AFF6F-16 | 1.7/16"X12 | 1.7/16"X12 | 1.7/16"X12 | O021 | O021 | O021 | 44.5 | 44.5 | 71 | 36 | 46 |
| AFF6F-20 | 1.11/16"X12 | 1.11/16"X12 | 1.11/16"X12 | O025 | O025 | O025 | 47.5 | 47.5 | 76 | 41 | 50 |
| AFF6F-24 | 2"X12 | 2"X12 | 2"X12 | O029 | O029 | O029 | 53.5 | 53.5 | 80 | 50 | 60 |

注：如需带锁母订货，则请在代号后加“LN”，如AFF6F-16LN，锁母代号为8F。 Note: In case if you are interested to order the adapter with lock nut, please insert suffix "LN" after our part no., for example AFF6F-16LN, The lock nut no. is 8F.

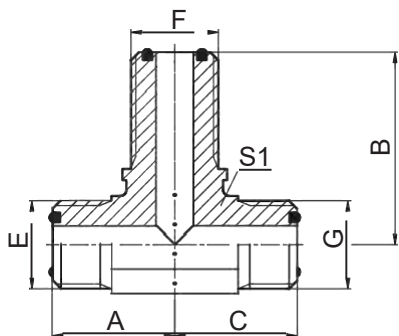

AF6FF

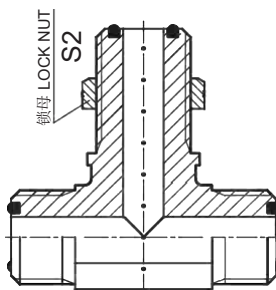

AF6FF-LN

美制ORFS外螺纹
O形圈平面密封过板接头三通
ORFS MALE O-RING
BULKHEAD BRANCH TEE

| 代号 PART NO. | 螺 纹 THREAD | | | O形圈 O-RING | | | 尺 寸 DIMENSIONS | | | | |
|----------------|-------------|-------------|-------------|------------|------|------|----------------|------|----|----|----|
| | E | F | G | E端 | F端 | G端 | A | B | C | S1 | S2 |
| AF6FF-04 | 9/16"X18 | 9/16"X18 | 9/16"X18 | O011 | O011 | O011 | 23 | 47 | 23 | 14 | 22 |
| AF6FF-06 | 11/16"X16 | 11/16"X16 | 11/16"X16 | O012 | O012 | O012 | 27 | 52 | 27 | 19 | 27 |
| AF6FF-08 | 13/16"X16 | 13/16"X16 | 13/16"X16 | O014 | O014 | O014 | 31 | 55.5 | 31 | 22 | 30 |
| AF6FF-10 | 1"X14 | 1"X14 | 1"X14 | O016 | O016 | O016 | 36.5 | 63 | 37 | 27 | 36 |
| AF6FF-12 | 1.3/16"X12 | 1.3/16"X12 | 1.3/16"X12 | O018 | O018 | O018 | 41 | 67.2 | 41 | 30 | 41 |
| AF6FF-16 | 1.7/16"X12 | 1.7/16"X12 | 1.7/16"X12 | O021 | O021 | O021 | 44.5 | 71.2 | 45 | 36 | 46 |
| AF6FF-20 | 1.11/16"X12 | 1.11/16"X12 | 1.11/16"X12 | O025 | O025 | O025 | 47.5 | 75.5 | 48 | 41 | 50 |
| AF6FF-24 | 2"X12 | 2"X12 | 2"X12 | O029 | O029 | O029 | 53.5 | 79.5 | 54 | 50 | 60 |

注：如需带锁母订货，则请在代号后加“LN”，如AF6FF-16LN，锁母代号为8F。 Note: In case if you are interested to order the adapter with lock nut, please insert suffix "LN" after our part no., for example AF6FF-16LN, The lock nut no. is 8F.

美制螺纹O型圈平面密封接头 ORFS Fittings

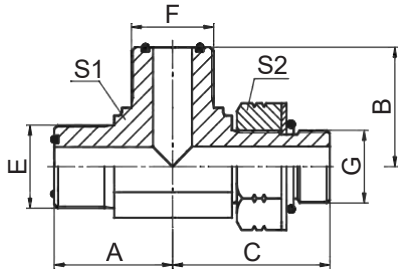

AFFO-OG

美制ORFS外螺纹O形圈平面密封
封 / 美制SAE外螺纹带O形圈重系列ISO 11926-2三通
ORFS MALE O-RING / SAE O-RING BOSS
S-SERIES ISO 11926-2 RUN TEE

| 代号 PART NO. | 螺 纹 THREAD | | | O形圈 O-RING | | | 尺 寸 DIMENSIONS | | | | |
|-----------------|-------------|-------------|------------|------------|------|------|----------------|------|------|----|----|
| | E | F | G | E端 | F端 | G端 | A | B | C | S1 | S2 |
| AFFO-04OG | 9/16"X18 | 9/16"X18 | 7/16"X20 | O011 | O011 | O904 | 23 | 23 | 30 | 14 | 17 |
| AFFO-04-04-06OG | 9/16"X18 | 9/16"X18 | 9/16"X18 | O011 | O011 | O906 | 23 | 23 | 32 | 14 | 19 |
| AFFO-06OG | 11/16"X16 | 11/16"X16 | 9/16"X18 | O012 | O012 | O906 | 27.5 | 27.5 | 35.5 | 19 | 19 |
| AFFO-06-06-08OG | 11/16"X16 | 11/16"X16 | 3/4"X16 | O012 | O012 | O908 | 27.5 | 27.5 | 38 | 19 | 24 |
| AFFO-08-08-06OG | 13/16"X16 | 13/16"X16 | 9/16"X18 | O014 | O014 | O906 | 31 | 31 | 37.5 | 22 | 19 |
| AFFO-08OG | 13/16"X16 | 13/16"X16 | 3/4"X16 | O014 | O014 | O908 | 31 | 31 | 40.5 | 22 | 24 |
| AFFO-08-08-10OG | 13/16"X16 | 13/16"X16 | 7/8"X14 | O014 | O014 | O910 | 31 | 31 | 45.3 | 22 | 27 |
| AFFO-08-08-12OG | 13/16"X16 | 13/16"X16 | 1.1/16"X12 | O014 | O014 | O912 | 34.5 | 34.5 | 54 | 27 | 32 |
| AFFO-10OG | 1"X14 | 1"X14 | 7/8"X14 | O016 | O016 | O910 | 36.5 | 36.5 | 50.8 | 27 | 27 |
| AFFO-10-10-12OG | 1"X14 | 1"X14 | 1.1/16"X12 | O016 | O016 | O912 | 36.5 | 36.5 | 52 | 27 | 32 |
| AFFO-12OG | 1.3/16"X12 | 1.3/16"X12 | 1.1/16"X12 | O018 | O018 | O912 | 40.3 | 40.3 | 55.3 | 30 | 32 |
| AFFO-16-16-12OG | 1.7/16"X12 | 1.7/16"X12 | 1.1/16"X12 | O021 | O021 | O912 | 44.5 | 44.5 | 59.5 | 36 | 32 |
| AFFO-16OG | 1.7/16"X12 | 1.7/16"X12 | 1.5/16"X12 | O021 | O021 | O916 | 44.5 | 44.5 | 59.3 | 36 | 41 |
| AFFO-20OG | 1.11/16"X12 | 1.11/16"X12 | 1.5/8"X12 | O025 | O025 | O920 | 47.5 | 47.5 | 60.5 | 41 | 50 |
| AFFO-24OG | 2"X12 | 2"X12 | 1.7/8"X12 | O029 | O029 | O924 | 53.5 | 53.5 | 68.5 | 50 | 55 |

注：F端与ISO 11926-1油口相配。 Note: F end is connected with ISO 11926-1 port.

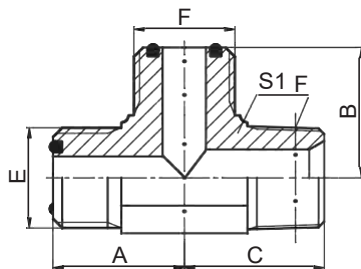

AFFN

ORFS外螺纹 / ORFS外螺纹 / NPT外螺纹
ORFS MALE / ORFS MALE / NPT MALE

| 代号 PART NO. | 螺 纹 THREAD | | | O形圈 O-RING | | | 尺 寸 DIMENSIONS | | | | |
|----------------|-------------|-------------|--------------|------------|------|--|----------------|------|------|----|--|
| | E | F | G | E端 | F端 | | A | B | C | S1 | |
| AFFN-04 | 9/16"X18 | 9/16"X18 | Z1/4"X18 | O011 | O011 | | 23 | 23 | 25.5 | 14 | |
| AFFN-06-06-04 | 11/16"X16 | 11/16"X16 | Z1/4"X18 | O012 | O012 | | 27.5 | 27.5 | 28.5 | 19 | |
| AFFN-06 | 11/16"X16 | 11/16"X16 | Z3/8"X18 | O012 | O012 | | 27.5 | 27.5 | 31 | 19 | |
| AFFN-08-08-06 | 13/16"X16 | 13/16"X16 | Z3/8"X18 | O014 | O014 | | 31 | 31 | 33.5 | 22 | |
| AFFN-08 | 13/16"X16 | 13/16"X16 | Z1/2"X14 | O014 | O014 | | 31 | 31 | 37.3 | 22 | |
| AFFN-10-10-08 | 1"X14 | 1"X14 | Z1/2"X14 | O016 | O016 | | 36.5 | 36.5 | 40 | 27 | |
| AFFN-12-12-08 | 1.3/16"X12 | 1.3/16"X12 | Z1/2"X14 | O018 | O018 | | 41 | 41 | 41.5 | 30 | |
| AFFN-12 | 1.3/16"X12 | 1.3/16"X12 | Z3/4"X14 | O018 | O018 | | 41 | 41 | 45.5 | 30 | |
| AFFN-16 | 1.7/16"X12 | 1.7/16"X12 | Z1"X11.5 | O021 | O021 | | 44.5 | 44.5 | 51.5 | 36 | |
| AFFN-20 | 1.11/16"X12 | 1.11/16"X12 | Z1.1/4"X11.5 | O025 | O025 | | 47.5 | 47.5 | 54.5 | 41 | |
| AFFN-24 | 2"X12 | 2"X12 | Z1.1/2"X11.5 | O029 | O029 | | 53.5 | 53.5 | 61 | 50 | |

美制螺纹O型圈平面密封接头 ORFS Fittings

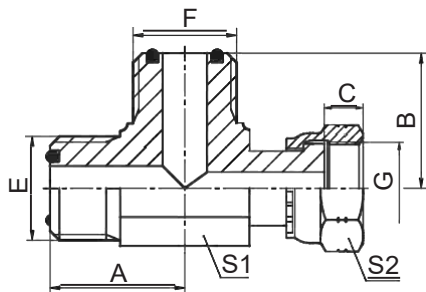

CF

美制ORFS外螺纹O形圈平面密封 / 美制ORFS内螺纹平面三通
ORFS MALE O-RING / ORFS FEMALE RUN TEE

| 代号 PART NO. | 螺 纹 THREAD | | | O形圈 O-RING | | 尺 寸 DIMENSIONS | | | | |
|----------------|-------------|-------------|-------------|------------|------|----------------|------|------|----|----|
| | E | F | G | E端 | F端 | A | B | C | S1 | S2 |
| CF-04 | 9/16"X18 | 9/16"X18 | 9/16"X18 | O011 | O011 | 23 | 23 | 8.5 | 14 | 19 |
| CF-06 | 11/16"X16 | 11/16"X16 | 11/16"X16 | O012 | O012 | 27.5 | 27.5 | 10 | 19 | 22 |
| CF-08 | 13/16"X16 | 13/16"X16 | 13/16"X16 | O014 | O014 | 31 | 31 | 11 | 22 | 27 |
| CF-10 | 1"X14 | 1"X14 | 1"X14 | O016 | O016 | 36.5 | 36.5 | 13.5 | 27 | 30 |
| CF-12 | 1.3/16"X12 | 1.3/16"X12 | 1.3/16"X12 | O018 | O018 | 40.3 | 40.3 | 15 | 30 | 36 |
| CF-16 | 1.7/16"X12 | 1.7/16"X12 | 1.7/16"X12 | O021 | O021 | 44.5 | 44.5 | 15 | 36 | 41 |
| CF-20 | 1.11/16"X12 | 1.11/16"X12 | 1.11/16"X12 | O025 | O025 | 47.5 | 47.5 | 15 | 41 | 50 |
| CF-24 | 2"X12 | 2"X12 | 2"X12 | O029 | O029 | 53.5 | 53.5 | 15 | 50 | 60 |

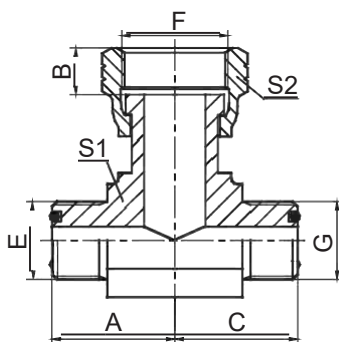

BF

ORFS外螺纹 / ORFS内螺纹 / ORFS外螺纹
ORFS MALE / ORFS FEMALE / ORFS MALE

| 代号 PART NO. | 螺 纹 THREAD | | | O形圈 O-RING | | 尺 寸 DIMENSIONS | | | | |
|----------------|-------------|-------------|-------------|------------|------------|----------------|------|------|----|----|
| | E | F | G | E端 | G端 | A | B | C | S1 | S2 |
| BF-04 | 9/16"X18 | 9/16"X18 | 9/16"X18 | 7.65X1.78 | 7.65X1.78 | 23 | 8.5 | 23 | 14 | 19 |
| BF-06 | 11/16"X16 | 11/16"X16 | 11/16"X16 | 9.25X1.78 | 9.25X1.78 | 27 | 10 | 27 | 19 | 22 |
| BF-08 | 13/16"X16 | 13/16"X16 | 13/16"X16 | 12.42X1.78 | 12.42X1.78 | 31 | 11 | 31 | 22 | 27 |
| BF-10 | 1"X14 | 1"X14 | 1"X14 | 15.6X1.78 | 15.6X1.78 | 36.5 | 13.5 | 36.5 | 27 | 30 |
| BF-12 | 1.3/16"X12 | 1.3/16"X12 | 1.3/16"X12 | 18.77X1.78 | 18.77X1.78 | 40.3 | 15 | 40.3 | 30 | 36 |
| BF-16 | 1.7/16"X12 | 1.7/16"X12 | 1.7/16"X12 | 23.52X1.78 | 23.52X1.78 | 44.5 | 15 | 44.5 | 36 | 41 |
| BF-20 | 1.11/16"X12 | 1.11/16"X12 | 1.11/16"X12 | 29.87X1.78 | 29.87X1.78 | 47.5 | 15 | 47.5 | 41 | 50 |
| BF-24 | 2"X12 | 2"X12 | 2"X12 | 37.82X1.78 | 37.82X1.78 | 53.5 | 15 | 53.5 | 50 | 60 |

美制螺纹O型圈平面密封接头 ORFS Fittings

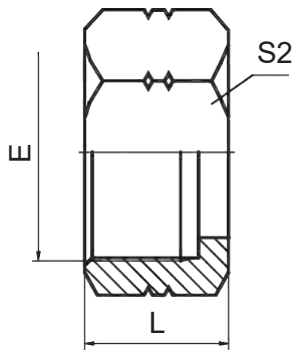

NB200-F

ORFS 螺母
ORFS TUBE END NUT

| 代号 PART NO. | 螺纹 E THREAD | 英制衬套 INCH SLEEVE | | 公制衬套 METRIC SLEEVE | | 尺寸 DIMENSIONS | | |
|----------------|----------------|------------------|-----------|--------------------|-----------|---------------|----|--|
| | | 管子外径 O.D. | 衬套代号 NO. | 管子外径 O.D. | 衬套代号 NO. | L | S2 | |
| NB200-04F | 9/16"X18 | 1/4" | NB300-04F | 6 | NB500-06F | 14.7 | 19 | |
| NB200-06F | 11/16"X16 | 3/8" | NB300-06F | 10 | NB500-10F | 17 | 22 | |
| NB200-08F | 13/16"X16 | 1/2" | NB300-08F | 12 | NB500-12F | 21 | 27 | |
| NB200-10F | 1"X14 | 5/8" | NB300-10F | 16 | NB500-16F | 23.5 | 30 | |
| NB200-12F | 1.3/16"X12 | 3/4" | NB300-12F | 20 | NB500-20F | 26 | 36 | |
| NB200-16F | 1.7/16"X12 | 1" | NB300-16F | 25 | NB500-25F | 27.8 | 41 | |
| NB200-20F | 1.11/16"X12 | 1.1/4" | NB300-20F | 30 | NB500-30F | 27.8 | 50 | |
| NB200-24F | 2"X12 | 1.1/2" | NB300-24F | 38 | NB500-38F | 27.8 | 60 | |

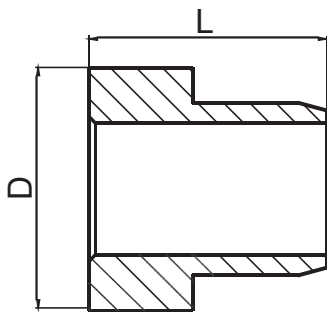

NB300-F

ORFS 英制管衬套
ORFS INCH SLEEVE

| 代号 PART NO. | 螺 纹 THREAD | 管子外径 TUBE O.D. | | 尺 寸 DIMENSIONS | | |
|----------------|---------------|----------------|--|-------------------|------|--|
| | | in | | D | L | |
| NB300-04F | 9/16"X18 | 1/4" | | 12.8 | 8.5 | |
| NB300-06F | 11/16"X16 | 3/8" | | 15.8 | 8.5 | |
| NB300-08F | 13/16"X16 | 1/2" | | 18.9 | 8.5 | |
| NB300-10F | 1"X14 | 5/8" | | 23.4 | 9 | |
| NB300-12F | 1.3/16"X12 | 3/4" | | 27.9 | 12.5 | |
| NB300-16F | 1.7/16"X12 | 1" | | 34.2 | 14 | |
| NB300-20F | 1.11/16"X12 | 1.1/4" | | 40.6 | 14 | |
| NB300-24F | 2"X12 | 1.1/2" | | 48.5 | 14 | |

美制螺纹O型圈平面密封接头 ORFS Fittings

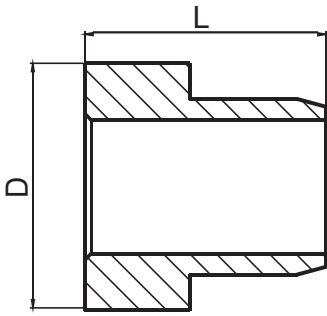



NB500-F

ORFS公制管衬套
ORFS METRIC SLEEVE

| 代号 PART NO. | 螺 纹 THREAD | 管子外径 TUBE O.D. | | 尺 寸 DIMENSIONS | | | | | |
|----------------|---------------|----------------|----|----------------|------|--|--|--|--|
| | | | MM | D | L | | | | |
| NB500-06F | 9/16"X18 | | 6 | 12.8 | 8.5 | | | | |
| NB500-10F | 11/16"X16 | | 10 | 15.8 | 8.5 | | | | |
| NB500-12F | 13/16"X16 | | 12 | 18.9 | 8.5 | | | | |
| NB500-16F | 1"X14 | | 16 | 23.4 | 9 | | | | |
| NB500-20F | 1.3/16"X12 | | 20 | 27.9 | 12.5 | | | | |
| NB500-25F | 1.7/16"X12 | | 25 | 34.2 | 14 | | | | |
| NB500-30F | 1.11/16"X12 | | 30 | 40.6 | 14 | | | | |
| NB500-38F | 2"X12 | | 38 | 48.5 | 14 | | | | |

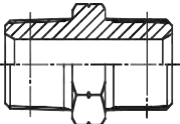
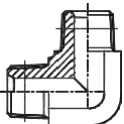
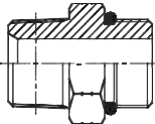
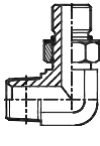

型号索引 Part NO. Index

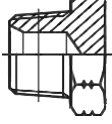
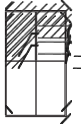
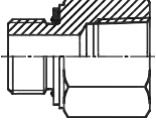
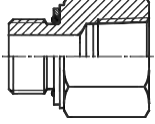
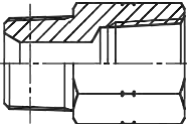
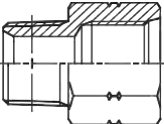
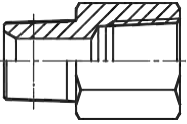
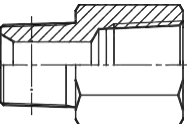
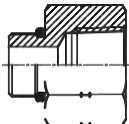
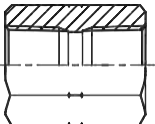
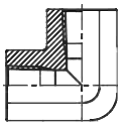
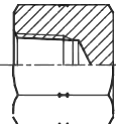
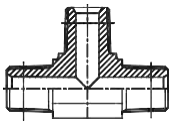
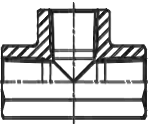
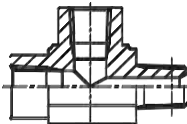
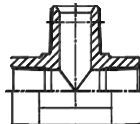
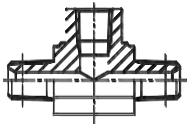
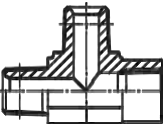
| | | | | | |
|--|---|---|---|---|---|
|  1N PJ1 |  1N9 PJ2 |  1NO PJ3 |  1NO9-OG PJ3 |  1NT PJ4 |  4N PJ5 |
|  4NN PJ5 |  5GN PJ6 |  5HN PJ6 |  5N PJ7 |  5NO PJ8 |  5NT PJ9 |
|  5TN-SP PJ9 |  5ON PJ10 |  7N PJ11 |  7N9-PK PJ12 |  9N-CAP PJ12 |  AN PJ13 |
|  GN-PK PJ13 |  HN PJ14 |  JN PJ14 |  KN PJ15 |  LN PJ15 | |
| | | | | | |
| | | | | | |
| | | | | | |

美制锥管螺纹NPT接头 NPT Thread Fittings

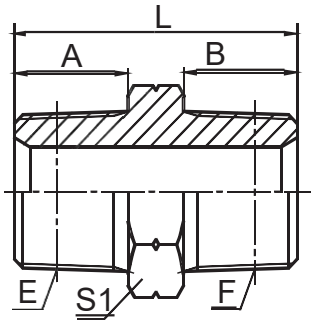

1N

美制布锥管外螺纹
NPT MALE

| 代号 PART NO. | 螺纹 THREAD | | 尺寸 DIMENSIONS | | | | | |
|----------------|--------------|--------------|---------------|------|------|----|--|--|
| | E | F | A | B | L | S1 | | |
| 1N-02 | Z1/8"X27 | Z1/8"X27 | 10.5 | 10.5 | 27 | 12 | | |
| 1N-02-04 | Z1/8"X27 | Z1/4"X18 | 10.5 | 15 | 31 | 17 | | |
| 1N-02-06 | Z1/8"X27 | Z3/8"X18 | 10.5 | 16 | 32 | 19 | | |
| 1N-04 | Z1/4"X18 | Z1/4"X18 | 15 | 15 | 35 | 17 | | |
| 1N-04-06 | Z1/4"X18 | Z3/8"X18 | 15 | 16 | 37 | 19 | | |
| 1N-04-08 | Z1/4"X18 | Z1/2"X14 | 15 | 19.5 | 41.5 | 22 | | |
| 1N-06 | Z3/8"X18 | Z3/8"X18 | 16 | 16 | 38 | 19 | | |
| 1N-06-08 | Z3/8"X18 | Z1/2"X14 | 16 | 19.5 | 43.5 | 22 | | |
| 1N-06-12 | Z3/8"X18 | Z3/4"X14 | 16 | 19.5 | 45.5 | 27 | | |
| 1N-08 | Z1/2"X14 | Z1/2"X14 | 19.5 | 19.5 | 47 | 22 | | |
| 1N-08-12 | Z1/2"X14 | Z3/4"X14 | 19.5 | 19.5 | 49 | 27 | | |
| 1N-08-16 | Z1/2"X14 | Z1"X11.5 | 19.5 | 25.5 | 56 | 36 | | |
| 1N-12 | Z3/4"X14 | Z3/4"X14 | 19.5 | 19.5 | 49 | 27 | | |
| 1N-12-16 | Z3/4"X14 | Z1"X11.5 | 19.5 | 25.5 | 55 | 36 | | |
| 1N-12-20 | Z3/4"X14 | Z1.1/4"X11.5 | 19.5 | 26.5 | 58 | 46 | | |
| 1N-16 | Z1"X11.5 | Z1"X11.5 | 25.5 | 25.5 | 61 | 36 | | |
| 1N-16-20 | Z1"X11.5 | Z1.1/4"X11.5 | 25.5 | 26.5 | 64 | 46 | | |
| 1N-16-24 | Z1"X11.5 | Z1.1/2"X11.5 | 25.5 | 27.5 | 68 | 50 | | |
| 1N-20 | Z1.1/4"X11.5 | Z1.1/4"X11.5 | 26.5 | 26.5 | 65 | 46 | | |
| 1N-20-24 | Z1.1/4"X11.5 | Z1.1/2"X11.5 | 26.5 | 27.5 | 69 | 50 | | |
| 1N-24 | Z1.1/2"X11.5 | Z1.1/2"X11.5 | 27.5 | 27.5 | 69 | 50 | | |
| 1N-24-32 | Z1.1/2"X11.5 | Z2"X11.5 | 27.5 | 27.5 | 72 | 65 | | |
| 1N-32 | Z2"X11.5 | Z2"X11.5 | 27.5 | 27.5 | 71 | 65 | | |

J

美制锥管螺纹NPT接头 NPT Thread Fittings

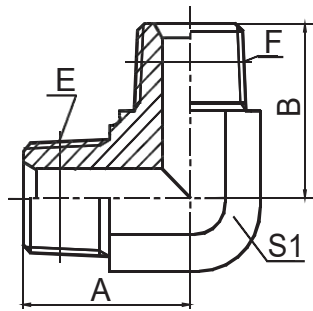

1N9

90° 弯布锥管外螺纹
90° ELBOW NPT MALE

| 代号 PART NO. | 螺 纹 THREAD | | 尺 寸 DIMENSIONS | | | | | |
|----------------|--------------|--------------|----------------|------|----|--|--|--|
| | E | F | A | B | S1 | | | |
| 1N9-02 | Z1/8"X27 | Z1/8"X27 | 21 | 21 | 11 | | | |
| 1N9-02-04 | Z1/8"X27 | Z1/4"X18 | 23.5 | 25.5 | 14 | | | |
| 1N9-04 | Z1/4"X18 | Z1/4"X18 | 25.5 | 25.5 | 14 | | | |
| 1N9-04-06 | Z1/4"X18 | Z3/8"X18 | 28 | 31 | 19 | | | |
| 1N9-04-08 | Z1/4"X18 | Z1/2"X14 | 30.5 | 36.5 | 22 | | | |
| 1N9-06 | Z3/8"X18 | Z3/8"X18 | 31 | 31 | 19 | | | |
| 1N9-06-08 | Z3/8"X18 | Z1/2"X14 | 33.8 | 37.3 | 22 | | | |
| 1N9-08 | Z1/2"X14 | Z1/2"X14 | 37.3 | 37.3 | 22 | | | |
| 1N9-08-12 | Z1/2"X14 | Z3/4"X14 | 40 | 44 | 27 | | | |
| 1N9-12 | Z3/4"X14 | Z3/4"X14 | 44 | 44 | 27 | | | |
| 1N9-12-16 | Z3/4"X14 | Z1"X11.5 | 46.5 | 50 | 33 | | | |
| 1N9-16 | Z1"X11.5 | Z1"X11.5 | 50 | 50 | 33 | | | |
| 1N9-20 | Z1.1/4"X11.5 | Z1.1/4"X11.5 | 53 | 53 | 41 | | | |
| 1N9-24 | Z1.1/2"X11.5 | Z1.1/2"X11.5 | 63 | 63 | 48 | | | |
| 1N9-32 | Z2"X11.5 | Z2"X11.5 | 68 | 68 | 63 | | | |

美制锥管螺纹NPT接头 NPT Thread Fittings

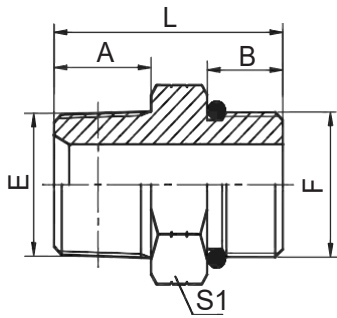

1NO

美制NPT外螺纹 / 美制
SAE外螺纹带O形圈轻系列ISO 11926-3
NPT MALE / SAE
O-RING BOSS L-SERIES ISO 11926-3

| 代号 PART NO. | 螺纹 THREAD | | O形圈 O-RING | | 尺寸 DIMENSIONS | | | | |
|----------------|--------------|------------|------------|------|---------------|------|------|----|--|
| | E | F | | F端 | A | B | L | S1 | |
| 1NO-04 | Z1/4"X18 | 7/16"X20 | | O904 | 15 | 9.1 | 30 | 14 | |
| 1NO-04-06 | Z1/4"X18 | 9/16"X18 | | O906 | 15 | 9.9 | 31 | 17 | |
| 1NO-06-04 | Z3/8"X18 | 7/16"X20 | | O904 | 16 | 9.1 | 33.5 | 19 | |
| 1NO-06 | Z3/8"X18 | 9/16"X18 | | O906 | 16 | 9.9 | 32 | 19 | |
| 1NO-06-08 | Z3/8"X18 | 3/4"X16 | | O908 | 16 | 11.1 | 35.5 | 22 | |
| 1NO-08 | Z1/2"X14 | 3/4"X16 | | O908 | 19.5 | 11.1 | 38.5 | 22 | |
| 1NO-08-10 | Z1/2"X14 | 7/8"X14 | | O910 | 19.5 | 12.7 | 42 | 27 | |
| 1NO-08-12 | Z1/2"X14 | 1.1/16"X12 | | O912 | 19.5 | 15.1 | 45.5 | 32 | |
| 1NO-12-10 | Z3/4"X14 | 7/8"X14 | | O910 | 19.5 | 12.7 | 46.5 | 30 | |
| 1NO-12 | Z3/4"X14 | 1.1/16"X12 | | O912 | 19.5 | 15.1 | 45.5 | 32 | |
| 1NO-16 | Z1"X11.5 | 1.5/16"X12 | | O916 | 25.5 | 15.1 | 51.5 | 38 | |
| 1NO-20-16 | Z1.1/4"X11.5 | 1.5/16"X12 | | O916 | 26.5 | 15.1 | 58.5 | 46 | |
| 1NO-20 | Z1.1/4"X11.5 | 1.5/8"X12 | | O920 | 26.5 | 15.1 | 56.5 | 50 | |
| 1NO-24 | Z1.1/2"X11.5 | 1.7/8"X12 | | O924 | 27.5 | 15.1 | 57.5 | 55 | |

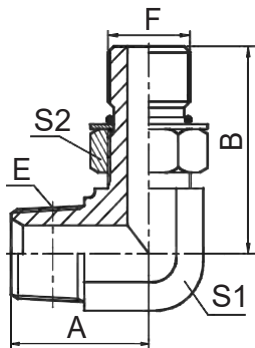

1NO9-OG

90° 美制NPT外螺纹 / SAE带O形圈
90° NPT MALE / SAE O-RING BOSS

| 代号 PART NO. | 螺纹 THREAD | | O形圈 O-RING | | 尺寸 DIMENSIONS | | | | |
|----------------|--------------|------------|------------|------|---------------|------|----|----|--|
| | E | F | | F端 | A | B | S1 | S2 | |
| 1NO9-02-04OG | Z1/8"X27 | 7/16"X20 | | O904 | 21 | 27.5 | 11 | 17 | |
| 1NO9-02-05OG | Z1/8"X27 | 1/2"X20 | | O905 | 23.5 | 29.9 | 14 | 17 | |
| 1NO9-04-06OG | Z1/4"X18 | 9/16"X18 | | O906 | 25.5 | 31.8 | 14 | 19 | |
| 1NO9-06-08OG | Z3/8"X18 | 3/4"X16 | | O908 | 31 | 37 | 19 | 24 | |
| 1NO9-08-10OG | Z1/2"X14 | 7/8"X14 | | O910 | 36.5 | 44 | 22 | 27 | |
| 1NO9-12OG | Z3/4"X14 | 1.1/16"X12 | | O912 | 44 | 51 | 27 | 32 | |
| 1NO9-12-14OG | Z3/4"X14 | 1.3/16"X12 | | O914 | 45 | 53 | 30 | 36 | |
| 1NO9-16OG | Z1"X11.5 | 1.5/16"X12 | | O916 | 50 | 55 | 33 | 41 | |
| 1NO9-20OG | Z1.1/4"X11.5 | 1.5/8"X12 | | O920 | 54.5 | 59.5 | 41 | 50 | |

美制锥管螺纹NPT接头 NPT Thread Fittings

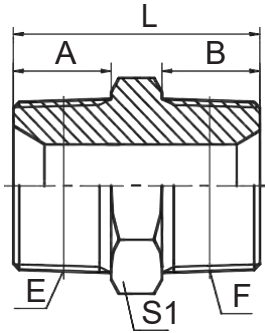

1NT

布锥管外螺纹 / 英锥管外螺纹
NPT MALE / BSPT MALE

| 代号 PART NO. | 螺 纹 THREAD | | 尺 寸 DIMENSIONS | | | | | |
|----------------|--------------|------------|----------------|--|------|------|------|----|
| | E | F | | | A | B | L | S1 |
| 1NT-02 | Z1/8"X27 | R1/8"X28 | | | 10.5 | 10 | 26.5 | 12 |
| 1NT-02-04 | Z1/8"X27 | R1/4"X19 | | | 10.5 | 14.5 | 31 | 17 |
| 1NT-04 | Z1/4"X18 | R1/4"X19 | | | 15 | 14.5 | 35 | 17 |
| 1NT-04-02 | Z1/4"X18 | R1/8"X28 | | | 15 | 10 | 31 | 17 |
| 1NT-04-06 | Z1/4"X18 | R3/8"X19 | | | 15.5 | 15 | 37 | 19 |
| 1NT-06 | Z3/8"X18 | R3/8"X19 | | | 16 | 15 | 37 | 19 |
| 1NT-06-04 | Z3/8"X18 | R1/4"X19 | | | 16 | 14.5 | 36.5 | 19 |
| 1NT-06-08 | Z3/8"X18 | R1/2"X14 | | | 16 | 20 | 44 | 22 |
| 1NT-08 | Z1/2"X14 | R1/2"X14 | | | 19.5 | 20 | 47.5 | 22 |
| 1NT-08-06 | Z1/2"X14 | R3/8"X19 | | | 19.5 | 15 | 42.5 | 22 |
| 1NT-08-12 | Z1/2"X14 | R3/4"X14 | | | 19.5 | 20 | 49.5 | 27 |
| 1NT-12 | Z3/4"X14 | R3/4"X14 | | | 19.5 | 20 | 49.5 | 27 |
| 1NT-12-08 | Z3/4"X14 | R1/2"X14 | | | 19.5 | 20 | 49.5 | 27 |
| 1NT-12-16 | Z3/4"X14 | R1"X11 | | | 19.5 | 25.5 | 56 | 36 |
| 1NT-16 | Z1"X11.5 | R1"X11 | | | 25.5 | 25.5 | 62 | 36 |
| 1NT-16-12 | Z1"X11.5 | R3/4"X14 | | | 25.5 | 20 | 56.5 | 36 |
| 1NT-16-20 | Z1"X11.5 | R1.1/4"X11 | | | 25.5 | 26.5 | 65 | 46 |
| 1NT-20 | Z1.1/4"X11.5 | R1.1/4"X11 | | | 26.5 | 26.5 | 66 | 46 |
| 1NT-20-16 | Z1.1/4"X11.5 | R1"X11 | | | 26.5 | 25.5 | 64 | 46 |
| 1NT-20-24 | Z1.1/4"X11.5 | R1.1/2"X11 | | | 26.5 | 26.5 | 68 | 50 |
| 1NT-24 | Z1.1/2"X11.5 | R1.1/2"X11 | | | 27.5 | 26.5 | 69 | 50 |
| 1NT-24-32 | Z1.1/2"X11.5 | R2"X11 | | | 27.5 | 30 | 74.5 | 65 |
| 1NT-32 | Z2"X11.5 | R2"X11 | | | 27.5 | 30 | 74.5 | 65 |

美制锥管螺纹NPT接头 NPT Thread Fittings

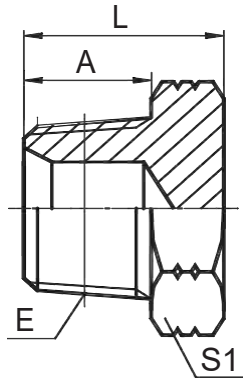

4N

美制布锥管外螺纹堵头
NPT MALE PLUG

| 代号 PART NO. | 螺 纹 THREAD | | | 尺 寸 DIMENSIONS | | | | |
|----------------|--------------|--|--|----------------|------|----|--|--|
| | E | | | A | L | S1 | | |
| 4N-02 | Z1/8"X27 | | | 10.5 | 16 | 12 | | |
| 4N-04 | Z1/4"X18 | | | 15 | 20 | 17 | | |
| 4N-06 | Z3/8"X18 | | | 16 | 21 | 19 | | |
| 4N-08 | Z1/2"X14 | | | 19.5 | 27 | 22 | | |
| 4N-12 | Z3/4"X14 | | | 19.5 | 29.5 | 27 | | |
| 4N-16 | Z1"X11.5 | | | 25.5 | 36.5 | 36 | | |
| 4N-20 | Z1.1/4"X11.5 | | | 26.5 | 38.5 | 46 | | |
| 4N-24 | Z1.1/2"X11.5 | | | 27.5 | 43 | 50 | | |
| 4N-32 | Z2"X11.5 | | | 27.5 | 43.5 | 65 | | |

J

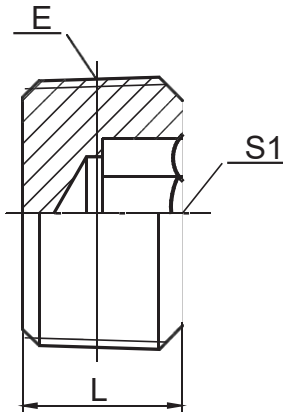

4NN

美布锥管外螺纹内六角堵头
NPT MALE HOLLOW HEX PLUG

| 代号 PART NO. | 螺 纹 THREAD | | | 尺 寸 DIMENSIONS | | | | |
|----------------|------------|--|--|----------------|----|--|--|--|
| | E | | | L | S1 | | | |
| 4NN-02 | Z1/8"X27 | | | 8 | 5 | | | |
| 4NN-04 | Z1/4"X18 | | | 10 | 6 | | | |
| 4NN-06 | Z3/8"X18 | | | 12 | 8 | | | |
| 4NN-08 | Z1/2"X14 | | | 15 | 10 | | | |
| 4NN-12 | Z3/4"X14 | | | 16 | 12 | | | |
| 4NN-16 | Z1"X11.5 | | | 18 | 17 | | | |

美制锥管螺纹NPT接头 NPT Thread Fittings

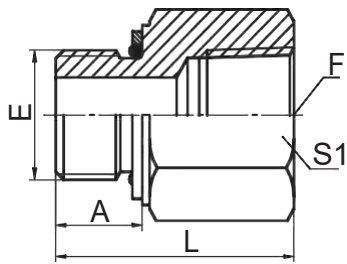

5GN

英管外螺纹O形圈 / 美制布锥管内螺纹
BSP MALE O-RING / NPT FEMALE

| 代号 PART NO. | 螺纹 THREAD | | O形圈 O-RING | | 尺寸 DIMENSIONS | | | |
|----------------|------------|--------------|------------|--|---------------|------|----|--|
| | E | F | E端 | | A | L | S1 | |
| 5GN-02 | G1/8"X28 | Z1/8"X27 | O011 | | 8 | 23 | 17 | |
| 5GN-02-04 | G1/8"X28 | Z1/4"X18 | O011 | | 8 | 27.5 | 19 | |
| 5GN-04-02 | G1/4"X19 | Z1/8"X27 | O111 | | 11 | 26.5 | 19 | |
| 5GN-04 | G1/4"X19 | Z1/4"X18 | O111 | | 11 | 31 | 19 | |
| 5GN-04-06 | G1/4"X19 | Z3/8"X18 | O111 | | 11 | 32 | 22 | |
| 5GN-06-04 | G3/8"X19 | Z1/4"X18 | O113 | | 11.5 | 33 | 24 | |
| 5GN-06 | G3/8"X19 | Z3/8"X18 | O113 | | 11.5 | 34 | 24 | |
| 5GN-08-04 | G1/2"X14 | Z1/4"X18 | O115 | | 14 | 25.5 | 27 | |
| 5GN-08-06 | G1/2"X14 | Z3/8"X18 | O115 | | 14 | 32.5 | 27 | |
| 5GN-08 | G1/2"X14 | Z1/2"X14 | O115 | | 14 | 41.5 | 30 | |
| 5GN-12 | G3/4"X14 | Z3/4"X14 | O119 | | 15.5 | 43 | 36 | |
| 5GN-16 | G1"X11 | Z1"X11.5 | O217 | | 18 | 53 | 41 | |
| 5GN-20 | G1.1/4"X11 | Z1.1/4"X11.5 | O222 | | 20 | 54 | 50 | |
| 5GN-24 | G1.1/2"X11 | Z1.1/2"X11.5 | O224 | | 21.5 | 57 | 60 | |

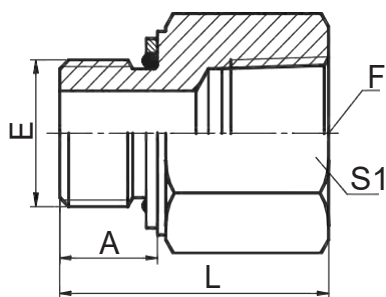

5HN

公制外螺纹轻系列ISO 6149-3 / 布锥管内螺纹
METRIC MALE L-SERIES ISO 6149-3 / NPT FEMALE

| 代号 PART NO. | 螺纹 THREAD | | O形圈 O-RING | | 尺寸 DIMENSIONS | | | |
|----------------|-----------|--------------|------------|--|---------------|------|----|--|
| | E | F | E端 | | A | L | S1 | |
| 5HN-10-02 | M10X1 | Z1/8"X27 | O08.1X1.6 | | 8.5 | 24 | 14 | |
| 5HN-12-02 | M12X1.5 | Z1/8"X27 | O09.3X2.4 | | 11 | 26 | 17 | |
| 5HN-12-04 | M12X1.5 | Z1/4"X18 | O09.3X2.4 | | 11 | 31.5 | 19 | |
| 5HN-14-04 | M14X1.5 | Z1/4"X18 | O11.3X2.4 | | 11 | 32 | 19 | |
| 5HN-16-06 | M16X1.5 | Z3/8"X18 | O13.3X2.4 | | 11.5 | 34.5 | 22 | |
| 5HN-16-08 | M16X1.5 | Z1/2"X14 | O13.3X2.4 | | 12.5 | 40 | 30 | |
| 5HN-18-06 | M18X1.5 | Z3/8"X18 | O15.3X2.4 | | 12.5 | 35 | 24 | |
| 5HN-18-08 | M18X1.5 | Z1/2"X14 | O15.3X2.4 | | 14 | 41.5 | 30 | |
| 5HN-22-08 | M22X1.5 | Z1/2"X14 | O19.3X2.4 | | 15 | 42.5 | 30 | |
| 5HN-27-12 | M27X2 | Z3/4"X14 | O23.5X3.0 | | 18.5 | 47.5 | 36 | |
| 5HN-33-16 | M33X2 | Z1"X11.5 | O29.5X3.0 | | 18.5 | 53.5 | 41 | |
| 5HN-42-20 | M42X2 | Z1.1/4"X11.5 | O38.5X3.0 | | 16 | 52 | 50 | |
| 5HN-48-24 | M48X2 | Z1.1/2"X11.5 | O44.5X3.0 | | 17.5 | 53 | 60 | |

美制锥管螺纹NPT接头 NPT Thread Fittings

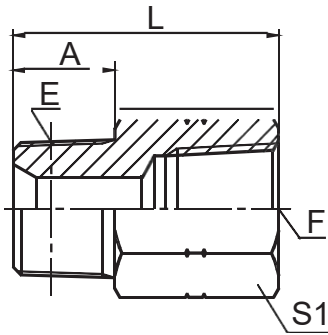

5N

布锥管外螺纹 / 布锥管内螺纹
NPT MALE / NPT FEMALE

| 代号 PART NO. | 螺 纹 THREAD | | 尺 寸 DIMENSIONS | | | | |
|----------------|--------------|--------------|----------------|------|----|--|--|
| | E | F | A | L | S1 | | |
| 5N-02 | Z1/8"X27 | Z1/8"X27 | 10.5 | 25.5 | 17 | | |
| 5N-02-04 | Z1/8"X27 | Z1/4"X18 | 10.5 | 31 | 19 | | |
| 5N-02-06 | Z1/8"X27 | Z3/8"X18 | 11 | 31 | 24 | | |
| 5N-04-02 | Z1/4"X18 | Z1/8"X27 | 15 | 22 | 17 | | |
| 5N-04 | Z1/4"X18 | Z1/4"X18 | 15 | 35.3 | 19 | | |
| 5N-04-06 | Z1/4"X18 | Z3/8"X18 | 15 | 36.6 | 24 | | |
| 5N-04-08 | Z1/4"X18 | Z1/2"X14 | 15 | 43 | 30 | | |
| 5N-06-02 | Z3/8"X18 | Z1/8"X27 | 16 | 22 | 19 | | |
| 5N-06-04 | Z3/8"X18 | Z1/4"X18 | 16 | 22 | 19 | | |
| 5N-06 | Z3/8"X18 | Z3/8"X18 | 16 | 37.6 | 24 | | |
| 5N-06-08 | Z3/8"X18 | Z1/2"X14 | 17 | 43.7 | 30 | | |
| 5N-06-12 | Z3/8"X18 | Z3/4"X14 | 17 | 47 | 36 | | |
| 5N-08-04 | Z1/2"X14 | Z1/4"X18 | 19.5 | 28 | 24 | | |
| 5N-08-06 | Z1/2"X14 | Z3/8"X18 | 19.5 | 28.5 | 24 | | |
| 5N-08 | Z1/2"X14 | Z1/2"X14 | 19.5 | 47.5 | 30 | | |
| 5N-08-12 | Z1/2"X14 | Z3/4"X14 | 19.5 | 49 | 36 | | |
| 5N-12-06 | Z3/4"X14 | Z3/8"X18 | 19.5 | 30.5 | 27 | | |
| 5N-12-08 | Z3/4"X14 | Z1/2"X14 | 19.5 | 30.5 | 27 | | |
| 5N-12 | Z3/4"X14 | Z3/4"X14 | 19.5 | 49 | 36 | | |
| 5N-12-16 | Z3/4"X14 | Z1"X11.5 | 19.5 | 55.4 | 41 | | |
| 5N-16-08 | Z1"X11.5 | Z1/2"X14 | 25.5 | 35.5 | 36 | | |
| 5N-16-12 | Z1"X11.5 | Z3/4"X14 | 25.5 | 36.5 | 36 | | |
| 5N-16 | Z1"X11.5 | Z1"X11.5 | 25.5 | 60.7 | 41 | | |
| 5N-16-20 | Z1"X11.5 | Z1.1/4"X11.5 | 25.5 | 63.5 | 50 | | |
| 5N-20-12 | Z1.1/4"X11.5 | Z3/4"X14 | 26.5 | 38.5 | 46 | | |
| 5N-20-16 | Z1.1/4"X11.5 | Z1"X11.5 | 26.5 | 41 | 46 | | |
| 5N-20 | Z1.1/4"X11.5 | Z1.1/4"X11.5 | 26.5 | 61.5 | 50 | | |
| 5N-20-24 | Z1.1/4"X11.5 | Z1.1/2"X11.5 | 26.5 | 62.5 | 60 | | |
| 5N-24-16 | Z1.1/2"X11.5 | Z1"X11.5 | 27.5 | 41.5 | 50 | | |
| 5N-24-20 | Z1.1/2"X11.5 | Z1.1/4"X11.5 | 27.5 | 41 | 50 | | |
| 5N-24 | Z1.1/2"X11.5 | Z1.1/2"X11.5 | 27.5 | 62.5 | 65 | | |
| 5N-24-32 | Z1.1/2"X11.5 | Z2"X11.5 | 27.5 | 66.5 | 70 | | |
| 5N-32-20 | Z2"X11.5 | Z1.1/4"X11.5 | 27.5 | 44.5 | 65 | | |
| 5N-32-24 | Z2"X11.5 | Z1.1/2"X11.5 | 27.5 | 45 | 65 | | |
| 5N-32 | Z2"X11.5 | Z2"X11.5 | 27.5 | 62.5 | 70 | | |

J

美制锥管螺纹NPT接头 NPT Thread Fittings

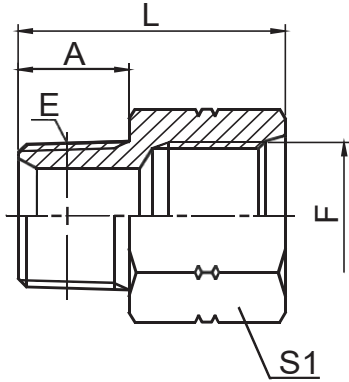

5NO

布锥管外螺纹 / 美制SAE内螺纹ISO 11926-1
NPT MALE / SAE FEMALE ISO 11926-1

| 代号 PART NO. | 螺纹 THREAD | | 尺寸 DIMENSIONS | | | | | | |
|----------------|--------------|------------|---------------|--|------|------|----|--|--|
| | E | F | | | A | L | S1 | | |
| 5NO-02-04 | Z1/8"X27 | 7/16"X20 | | | 10.5 | 29.5 | 17 | | |
| 5NO-02-05 | Z1/8"X27 | 1/2"X20 | | | 10.5 | 30.5 | 17 | | |
| 5NO-04 | Z1/4"X18 | 7/16"X20 | | | 15 | 34 | 17 | | |
| 5NO-04-06 | Z1/4"X18 | 9/16"X18 | | | 15 | 36 | 19 | | |
| 5NO-04-08 | Z1/4"X18 | 3/4"X16 | | | 15 | 41 | 27 | | |
| 5NO-06-04 | Z3/8"X18 | 7/16"X20 | | | 16 | 22 | 19 | | |
| 5NO-06 | Z3/8"X18 | 9/16"X18 | | | 16 | 34.5 | 19 | | |
| 5NO-06-08 | Z3/8"X18 | 3/4"X16 | | | 16 | 40 | 24 | | |
| 5NO-08-06 | Z1/2"X14 | 9/16"X18 | | | 19.5 | 27.5 | 24 | | |
| 5NO-08 | Z1/2"X14 | 3/4"X16 | | | 19.5 | 41.5 | 27 | | |
| 5NO-08-10 | Z1/2"X14 | 7/8"X14 | | | 19.5 | 46.5 | 30 | | |
| 5NO-12-08 | Z3/4"X14 | 3/4"X16 | | | 19.5 | 29.5 | 30 | | |
| 5NO-12-10 | Z3/4"X14 | 7/8"X14 | | | 19.5 | 42.5 | 30 | | |
| 5NO-12 | Z3/4"X14 | 1.1/16"X12 | | | 19.5 | 47 | 36 | | |
| 5NO-16-12 | Z1"X11.5 | 1.1/16"X12 | | | 25.5 | 52.5 | 36 | | |
| 5NO-16 | Z1"X11.5 | 1.5/16"X12 | | | 25.5 | 53 | 41 | | |
| 5NO-20 | Z1.1/4"X11.5 | 1.5/8"X12 | | | 26.5 | 55.5 | 50 | | |

美制锥管螺纹NPT接头 NPT Thread Fittings

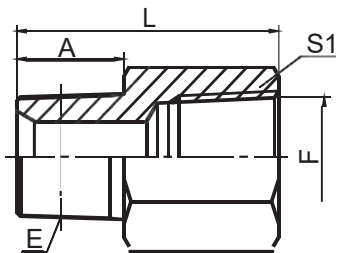

5NT

美制布锥管外螺纹 / 英锥管内螺纹
NPT MALE / BSPT FEMALE

| 代号 PART NO. | 螺 纹 THREAD | | 尺 寸 DIMENSIONS | | | |
|----------------|--------------|-------------|----------------|------|----|--|
| | E | F | A | L | S1 | |
| 5NT-04 | Z1/4"X18 | Rc1/4"X19 | 15 | 34.5 | 19 | |
| 5NT-04-02 | Z1/4"X18 | Rc1/8"X28 | 15 | 21 | 14 | |
| 5NT-04-06 | Z1/4"X18 | Rc3/8"X19 | 15 | 37 | 22 | |
| 5NT-06 | Z3/8"X18 | Rc3/8"X19 | 16 | 37.5 | 22 | |
| 5NT-06-04 | Z3/8"X18 | Rc1/4"X19 | 16 | 22 | 19 | |
| 5NT-06-08 | Z3/8"X18 | Rc1/2"X14 | 16 | 43 | 27 | |
| 5NT-08 | Z1/2"X14 | Rc1/2"X14 | 19.5 | 46 | 27 | |
| 5NT-08-06 | Z1/2"X14 | Rc3/8"X19 | 19.5 | 29.5 | 24 | |
| 5NT-08-12 | Z1/2"X14 | Rc3/4"X14 | 19.5 | 50 | 36 | |
| 5NT-12 | Z3/4"X14 | Rc3/4"X14 | 19.5 | 46 | 36 | |
| 5NT-12-08 | Z3/4"X14 | Rc1/2"X14 | 19.5 | 29.5 | 27 | |
| 5NT-12-16 | Z3/4"X14 | Rc1"X11 | 19.5 | 52 | 41 | |
| 5NT-16 | Z1"X11.5 | Rc1"X11 | 25.5 | 57 | 41 | |
| 5NT-16-12 | Z1"X11.5 | Rc3/4"X14 | 25.5 | 51 | 36 | |
| 5NT-16-20 | Z1"X11.5 | Rc1.1/4"X11 | 25.5 | 63.5 | 50 | |
| 5NT-20 | Z1.1/4"X11.5 | Rc1.1/4"X11 | 26.5 | 64.5 | 50 | |
| 5NT-20-16 | Z1.1/4"X11.5 | Rc1"X11 | 26.5 | 39.5 | 46 | |
| 5NT-20-24 | Z1.1/4"X11.5 | Rc1.1/2"X11 | 26.5 | 64.5 | 55 | |
| 5NT-24 | Z1.1/2"X11.5 | Rc1.1/2"X11 | 27.5 | 65.5 | 55 | |
| 5NT-32 | Z2"X11.5 | Rc2"X11 | 27.5 | 68.5 | 70 | |

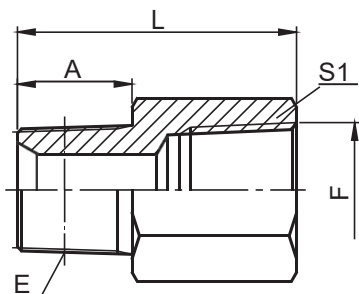

5TN-SP

英锥管外螺纹 / 美制布锥管内螺纹
BSPT MALE / NPT FEMALE

| 代号 PART NO. | 螺 纹 THREAD | | 尺 寸 DIMENSIONS | | | |
|----------------|------------|----------|----------------|------|----|--|
| | E | F | A | L | S1 | |
| 5TN-02SP | R1/8"X28 | Z1/8"X27 | 10 | 25 | 17 | |
| 5TN-04-02SP | R1/4"X19 | Z1/8"X27 | 14.5 | 21.5 | 14 | |
| 5TN-04SP | R1/4"X19 | Z1/4"X18 | 14.5 | 34.5 | 19 | |
| 5TN-06-04SP | R3/8"X19 | Z1/4"X18 | 15 | 23 | 19 | |
| 5TN-06SP | R3/8"X19 | Z3/8"X18 | 15 | 36.5 | 24 | |
| 5TN-08-06SP | R1/2"X14 | Z3/8"X18 | 20 | 28.5 | 24 | |
| 5TN-08SP | R1/2"X14 | Z1/2"X14 | 20 | 47 | 30 | |
| 5TN-12-08SP | R3/4"X14 | Z1/2"X14 | 20 | 30.5 | 32 | |
| 5TN-12SP | R3/4"X14 | Z3/4"X14 | 20 | 49 | 36 | |
| 5TN-16-12SP | R1"X11 | Z3/4"X14 | 25.5 | 36.5 | 36 | |
| 5TN-16SP | R1"X11 | Z1"X11.5 | 25.5 | 59 | 41 | |

美制锥管螺纹NPT接头 NPT Thread Fittings

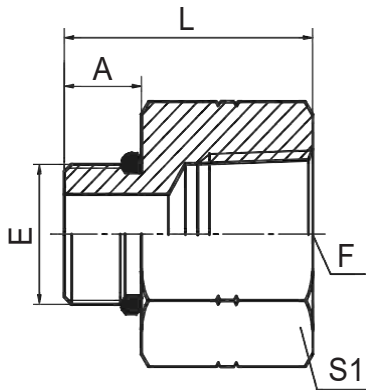

50N

美制SAE外螺纹带O形圈
 轻系列ISO 11926-3 / 布锥管内螺纹
 SAE O-RING BOSS
 L-SERIES ISO 11926-3 / NPT FEMALE

| 代号 PART NO. | 螺纹 THREAD | | O形圈 O-RING | | 尺寸 DIMENSIONS | | | | |
|----------------|------------|--------------|------------|--|---------------|------|----|--|--|
| | E | F | E端 | | A | L | S1 | | |
| 50N-02 | 5/16"X24 | Z1/8"X27 | O902 | | 7.54 | 24.5 | 17 | | |
| 50N-02-04 | 5/16"X24 | Z1/4"x18 | O902 | | 7.54 | 29 | 19 | | |
| 50N-03-02 | 3/8"X24 | Z1/8"X27 | O903 | | 7.54 | 24.5 | 17 | | |
| 50N-03-04 | 3/8"X24 | Z1/4"x18 | O903 | | 7.54 | 29 | 19 | | |
| 50N-04-02 | 7/16"X20 | Z1/8"X27 | O904 | | 9.1 | 24.5 | 17 | | |
| 50N-04 | 7/16"X20 | Z1/4"x18 | O904 | | 9.1 | 29 | 19 | | |
| 50N-04-06 | 7/16"X20 | Z3/8"x18 | O904 | | 9.1 | 30.7 | 24 | | |
| 50N-05-02 | 1/2"X20 | Z1/8"X27 | O905 | | 9.1 | 26 | 17 | | |
| 50N-06-04 | 9/16"X18 | Z1/4"x18 | O906 | | 9.9 | 31.5 | 19 | | |
| 50N-08-04 | 3/4"X16 | Z1/4"x18 | O908 | | 11.1 | 32.5 | 22 | | |
| 50N-08-06 | 3/4"X16 | Z3/8"x18 | O908 | | 11.1 | 34 | 22 | | |
| 50N-08 | 3/4"X16 | Z1/2"X14 | O908 | | 11.1 | 40 | 30 | | |
| 50N-08-12 | 3/4"X16 | Z3/4"x14 | O908 | | 11.1 | 40.1 | 36 | | |
| 50N-10-08 | 7/8"X14 | Z1/2"x14 | O910 | | 12.7 | 41.5 | 30 | | |
| 50N-10-06 | 7/8"X14 | Z3/8"x18 | O910 | | 12.7 | 35.5 | 27 | | |
| 50N-10-12 | 7/8"X14 | Z3/4"x14 | O910 | | 12.7 | 41 | 36 | | |
| 50N-12-08 | 1.1/16"X12 | Z1/2"x14 | O912 | | 15.1 | 42 | 32 | | |
| 50N-12 | 1.1/16"X12 | Z3/4"x14 | O912 | | 15.1 | 45.5 | 36 | | |
| 50N-12-16 | 1.1/16"X12 | Z1"X11.5 | O912 | | 15.1 | 50.5 | 41 | | |
| 50N-16-12 | 1.5/16"X12 | Z3/4"x14 | O916 | | 15.1 | 43 | 38 | | |
| 50N-16 | 1.5/16"X12 | Z1"X11.5 | O916 | | 15.1 | 51.5 | 41 | | |
| 50N-20-16 | 1.5/8"X12 | Z1"X11.5 | O920 | | 15.1 | 40 | 50 | | |
| 50N-20 | 1.5/8"X12 | Z1.1/4"X11.5 | O920 | | 15.1 | 53.5 | 50 | | |
| 50N-24-16 | 1.7/8"X12 | Z1"X11.5 | O924 | | 15.1 | 34 | 55 | | |
| 50N-24-20 | 1.7/8"X12 | Z1.1/4"X11.5 | O924 | | 15.1 | 48 | 55 | | |
| 50N-24 | 1.7/8"X12 | Z1.1/2"X11.5 | O924 | | 15.1 | 50 | 60 | | |
| 50N-32 | 2.1/2"X12 | 2"X11.5 | O932 | | 15.1 | 50 | 70 | | |

美制锥管螺纹NPT接头 NPT Thread Fittings

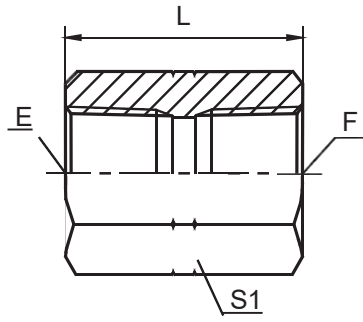

7N

布锥管内螺纹
NPT FEMALE

| 代号 PART NO. | 螺 纹 THREAD | | 尺 寸 DIMENSIONS | | | | | |
|----------------|--------------|--------------|----------------|----|--|--|--|--|
| | E | F | L | S1 | | | | |
| 7N-02 | Z1/8"X27 | Z1/8"X27 | 24 | 17 | | | | |
| 7N-02-04 | Z1/8"X27 | Z1/4"X18 | 27 | 19 | | | | |
| 7N-02-06 | Z1/8"X27 | Z3/8"X18 | 30 | 22 | | | | |
| 7N-04 | Z1/4"X18 | Z1/4"X18 | 29 | 19 | | | | |
| 7N-04-06 | Z1/4"X18 | Z3/8"X18 | 31 | 22 | | | | |
| 7N-04-08 | Z1/4"X18 | Z1/2"X14 | 35 | 30 | | | | |
| 7N-06 | Z3/8"X18 | Z3/8"X18 | 29 | 22 | | | | |
| 7N-06-08 | Z3/8"X18 | Z1/2"X14 | 38 | 30 | | | | |
| 7N-06-12 | Z3/8"X18 | Z3/4"X14 | 40 | 36 | | | | |
| 7N-08 | Z1/2"X14 | Z1/2"X14 | 38 | 30 | | | | |
| 7N-08-12 | Z1/2"X14 | Z3/4"X14 | 43 | 36 | | | | |
| 7N-12 | Z3/4"X14 | Z3/4"X14 | 39 | 36 | | | | |
| 7N-12-16 | Z3/4"X14 | Z1"X11.5 | 45.5 | 41 | | | | |
| 7N-16 | Z1"X11.5 | Z1"X11.5 | 48 | 41 | | | | |
| 7N-20 | Z1.1/4"X11.5 | Z1.1/4"X11.5 | 49 | 50 | | | | |
| 7N-24 | Z1.1/2"X11.5 | Z1.1/2"X11.5 | 49 | 60 | | | | |
| 7N-32 | Z2"X11.5 | Z2"X11.5 | 50 | 70 | | | | |

J

美制锥管螺纹NPT接头 NPT Thread Fittings

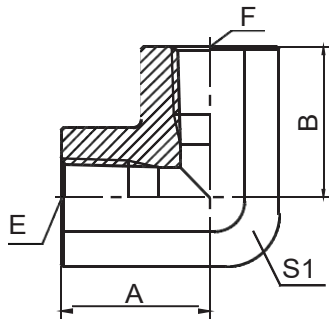

7N9-PK

90° 弯布锥管内螺纹
90° ELBOW NPT FEMALE

| 代号 PART NO. | 螺 纹 THREAD | | 尺 寸 DIMENSIONS | | | | | | |
|----------------|--------------|--------------|----------------|--|------|------|----|--|--|
| | E | F | | | A | B | S1 | | |
| 7N9-02PK | Z1/8"X27 | Z1/8"X27 | | | 20 | 20 | 16 | | |
| 7N9-02-04PK | Z1/8"X27 | Z1/4"X18 | | | 20 | 22.5 | 19 | | |
| 7N9-04PK | Z1/4"X18 | Z1/4"X18 | | | 22.5 | 22.5 | 19 | | |
| 7N9-04-06PK | Z1/4"X18 | Z3/8"X18 | | | 25 | 26 | 24 | | |
| 7N9-06PK | Z3/8"X18 | Z3/8"X18 | | | 26 | 26 | 24 | | |
| 7N9-06-08PK | Z3/8"X18 | Z1/2"X14 | | | 26 | 31 | 27 | | |
| 7N9-08PK | Z1/2"X14 | Z1/2"X14 | | | 31 | 31 | 27 | | |
| 7N9-08-12PK | Z1/2"X14 | Z3/4"X14 | | | 34 | 34 | 33 | | |
| 7N9-12PK | Z3/4"X14 | Z3/4"X14 | | | 34 | 34 | 33 | | |
| 7N9-12-16PK | Z3/4"X14 | Z1"X11.5 | | | 42 | 42 | 41 | | |
| 7N9-16PK | Z1"X11.5 | Z1"X11.5 | | | 42 | 42 | 41 | | |
| 7N9-20PK | Z1.1/4"X11.5 | Z1.1/4"X11.5 | | | 48 | 48 | 50 | | |
| 7N9-24PK | Z1.1/2"X11.5 | Z1.1/2"X11.5 | | | 53 | 53 | 60 | | |
| 7N9-32PK | Z2"X11.5 | Z2"X11.5 | | | 62 | 62 | 70 | | |

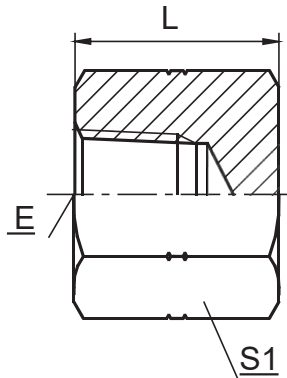

9N-CAP

美制布锥管内螺纹堵头
NPT FEMALE PLUG

| 代号 PART NO. | 螺 纹 THREAD | | 尺 寸 DIMENSIONS | | | | | | |
|----------------|--------------|--|----------------|--|------|----|--|--|--|
| | E | | | | L | S1 | | | |
| 9N-02CAP | Z1/8"X27 | | | | 17.5 | 17 | | | |
| 9N-04CAP | Z1/4"X18 | | | | 23 | 19 | | | |
| 9N-06CAP | Z3/8"X18 | | | | 24 | 24 | | | |
| 9N-08CAP | Z1/2"X14 | | | | 28 | 30 | | | |
| 9N-12CAP | Z3/4"X14 | | | | 28 | 36 | | | |
| 9N-16CAP | Z1"X11.5 | | | | 34 | 46 | | | |
| 9N-20CAP | Z1.1/4"X11.5 | | | | 37 | 55 | | | |
| 9N-24CAP | Z1.1/2"X11.5 | | | | 37 | 65 | | | |
| 9N-32CAP | Z2"X11.5 | | | | 40.5 | 75 | | | |

美制锥管螺纹NPT接头 NPT Thread Fittings

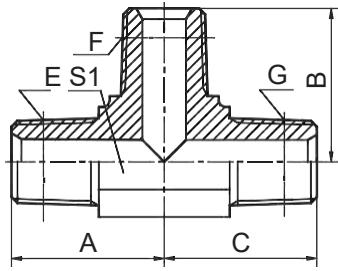

AN

美制布锥管外螺纹
NPT MALE

| 代号 PART NO. | 螺 纹 THREAD | | | 尺 寸 DIMENSIONS | | | | |
|----------------|--------------|--------------|--------------|----------------|------|------|----|--|
| | E | F | G | A | B | C | S1 | |
| AN-02 | Z1/8"X27 | Z1/8"X27 | Z1/8"X27 | 21 | 21 | 21 | 11 | |
| AN-04 | Z1/4"X18 | Z1/4"X18 | Z1/4"X18 | 25.5 | 25.5 | 25.5 | 14 | |
| AN-06 | Z3/8"X18 | Z3/8"X18 | Z3/8"X18 | 31 | 31 | 31 | 19 | |
| AN-08 | Z1/2"X14 | Z1/2"X14 | Z1/2"X14 | 36.7 | 36.7 | 36.7 | 22 | |
| AN-12 | Z3/4"X14 | Z3/4"X14 | Z3/4"X14 | 44 | 44 | 44 | 27 | |
| AN-16 | Z1"X11.5 | Z1"X11.5 | Z1"X11.5 | 50 | 50 | 50 | 33 | |
| AN-20 | Z1.1/4"X11.5 | Z1.1/4"X11.5 | Z1.1/4"X11.5 | 54.5 | 54.5 | 54.5 | 41 | |
| AN-24 | Z1.1/2"X11.5 | Z1.1/2"X11.5 | Z1.1/2"X11.5 | 59.5 | 59.5 | 59.5 | 48 | |

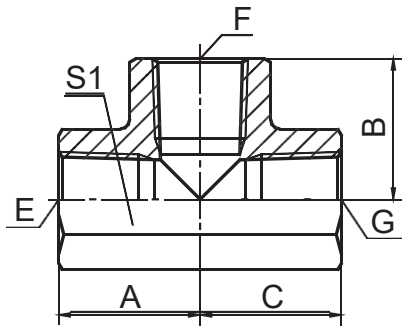

GN-PK

布锥管内螺纹三通
NPT FEMALE TEE

| 代号 PART NO. | 螺 纹 THREAD | | | 尺 寸 DIMENSIONS | | | | |
|----------------|--------------|--------------|--------------|----------------|------|------|----|--|
| | E | F | G | A | B | C | S1 | |
| GN-02PK | Z1/8"X27 | Z1/8"X27 | Z1/8"X27 | 20 | 20 | 20 | 16 | |
| GN-04PK | Z1/4"X18 | Z1/4"X18 | Z1/4"X18 | 22.5 | 22.5 | 22.5 | 19 | |
| GN-06PK | Z3/8"X18 | Z3/8"X18 | Z3/8"X18 | 26 | 26 | 26 | 24 | |
| GN-08PK | Z1/2"X14 | Z1/2"X14 | Z1/2"X14 | 31 | 31 | 31 | 27 | |
| GN-12PK | Z3/4"X14 | Z3/4"X14 | Z3/4"X14 | 34 | 34 | 34 | 33 | |
| GN-16PK | Z1"X11.5 | Z1"X11.5 | Z1"X11.5 | 42 | 42 | 42 | 41 | |
| GN-20PK | Z1.1/4"X11.5 | Z1.1/4"X11.5 | Z1.1/4"X11.5 | 48 | 48 | 48 | 50 | |
| GN-24PK | Z1.1/2"X11.5 | Z1.1/2"X11.5 | Z1.1/2"X11.5 | 53 | 53 | 53 | 60 | |
| GN-32PK | Z2"X11.5 | Z2"X11.5 | Z2"X11.5 | 62 | 62 | 62 | 70 | |

J

美制锥管螺纹NPT接头 NPT Thread Fittings

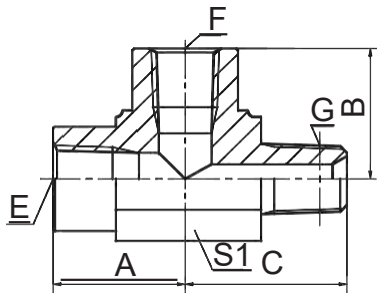

HN

布锥管内螺纹 / 布锥管外螺纹三通
NPT FEMALE / NPT MALE RUN TEE

| 代号 PART NO. | 螺 纹 THREAD | | | 尺 寸 DIMENSIONS | | | | | |
|----------------|--------------|--------------|--------------|----------------|----|------|----|--|--|
| | E | F | G | A | B | C | S1 | | |
| HN-02 | Z1/8"X27 | Z1/8"X27 | Z1/8"X27 | 20 | 20 | 24.5 | 16 | | |
| HN-04 | Z1/4"X18 | Z1/4"X18 | Z1/4"X18 | 25 | 25 | 28.5 | 19 | | |
| HN-06 | Z3/8"X18 | Z3/8"X18 | Z3/8"X18 | 27 | 27 | 33.5 | 24 | | |
| HN-08 | Z1/2"X14 | Z1/2"X14 | Z1/2"X14 | 35 | 35 | 42.5 | 30 | | |
| HN-12 | Z3/4"X14 | Z3/4"X14 | Z3/4"X14 | 37 | 37 | 45.2 | 33 | | |
| HN-16 | Z1"X11.5 | Z1"X11.5 | Z1"X11.5 | 44 | 44 | 54.7 | 41 | | |
| HN-20 | Z1.1/4"X11.5 | Z1.1/4"X11.5 | Z1.1/4"X11.5 | 48 | 48 | 58.5 | 48 | | |

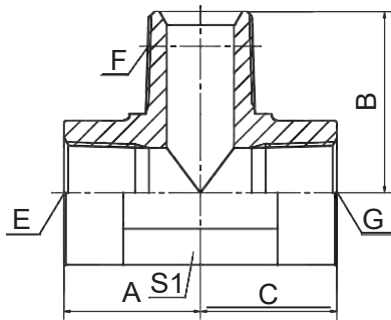

JN

布锥管内螺纹 / 布锥管外螺纹三通
NPT FEMALE / NPT MALE BRANCH TEE

| 代号 PART NO. | 螺 纹 THREAD | | | 尺 寸 DIMENSIONS | | | | | |
|----------------|------------|----------|----------|----------------|------|------|----|--|--|
| | E | F | G | A | B | C | S1 | | |
| JN-02 | Z1/8"X27 | Z1/8"X27 | Z1/8"X27 | 17.8 | 24.5 | 17.8 | 14 | | |
| JN-04 | Z1/4"X18 | Z1/4"X18 | Z1/4"X18 | 22.4 | 28 | 22.4 | 19 | | |
| JN-06 | Z3/8"X18 | Z3/8"X18 | Z3/8"X18 | 25 | 33.5 | 25 | 24 | | |
| JN-08 | Z1/2"X14 | Z1/2"X14 | Z1/2"X14 | 31.2 | 41.2 | 31.2 | 30 | | |
| JN-12 | Z3/4"X14 | Z3/4"X14 | Z3/4"X14 | 34.5 | 45.2 | 34.5 | 33 | | |
| JN-16 | Z1"X11.5 | Z1"X11.5 | Z1"X11.5 | 41.1 | 54.5 | 41.1 | 41 | | |

美制锥管螺纹NPT接头 NPT Thread Fittings

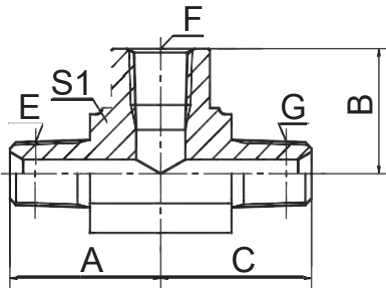

KN

布锥管外螺纹 / 布锥管内螺纹 / 布锥管外螺纹
NPT MALE / NPT FEMALE / NPT MALE

| 代号 PART NO. | 螺纹 THREAD | | | 尺寸 DIMENSIONS | | | | | |
|----------------|-----------|----------|----------|---------------|------|------|----|--|--|
| | E | F | G | A | B | C | S1 | | |
| KN-02 | Z1/8"X27 | Z1/8"X27 | Z1/8"X27 | 24.5 | 17.8 | 24.5 | 16 | | |
| KN-04 | Z1/4"X18 | Z1/4"X18 | Z1/4"X18 | 28 | 22.4 | 28 | 19 | | |
| KN-06 | Z3/8"X18 | Z3/8"X18 | Z3/8"X18 | 33.5 | 25 | 33.5 | 24 | | |
| KN-08 | Z1/2"X14 | Z1/2"X14 | Z1/2"X14 | 41.2 | 31.2 | 41.2 | 30 | | |
| KN-12 | Z3/4"X14 | Z3/4"X14 | Z3/4"X14 | 45.2 | 34.5 | 45.2 | 33 | | |
| KN-16 | Z1"X11.5 | Z1"X11.5 | Z1"X11.5 | 54.5 | 41.1 | 54.5 | 41 | | |

J

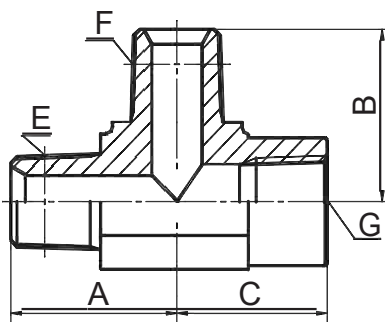

LN

布锥管外螺纹 / 布锥管外螺纹 / 布锥管内螺纹
NPT MALE / NPT MALE / NPT FEMALE

| 代号 PART NO. | 螺纹 THREAD | | | 尺寸 DIMENSIONS | | | | | |
|----------------|--------------|--------------|--------------|---------------|------|------|----|--|--|
| | E | F | G | A | B | C | S1 | | |
| LN-02 | Z1/8"X27 | Z1/8"X27 | Z1/8"X27 | 24.5 | 24.5 | 20.5 | 16 | | |
| LN-04 | Z1/4"X18 | Z1/4"X18 | Z1/4"X18 | 28 | 28 | 22.5 | 19 | | |
| LN-06 | Z3/8"X18 | Z3/8"X18 | Z3/8"X18 | 33.5 | 33.5 | 25 | 24 | | |
| LN-08 | Z1/2"X14 | Z1/2"X14 | Z1/2"X14 | 41.2 | 41.2 | 31.2 | 30 | | |
| LN-12 | Z3/4"X14 | Z3/4"X14 | Z3/4"X14 | 46.5 | 46.5 | 34.5 | 33 | | |
| LN-16 | Z1"X11.5 | Z1"X11.5 | Z1"X11.5 | 54.5 | 54.5 | 41.1 | 41 | | |
| LN-20 | Z1.1/4"X11.5 | Z1.1/4"X11.5 | Z1.1/4"X11.5 | 58.5 | 58.5 | 43.5 | 48 | | |
| LN-24 | Z1.1/2"X11.5 | Z1.1/2"X11.5 | Z1.1/2"X11.5 | 71.5 | 71.5 | 52.8 | 63 | | |

型号索引 Part NO. Index

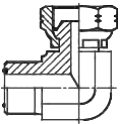
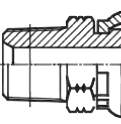
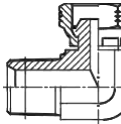
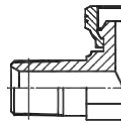
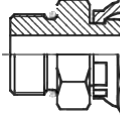
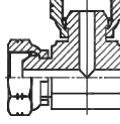
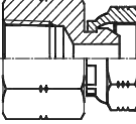
| | | | | | |
|--|--|---|---|--|---|
|  <p>2FU9 PK1</p> |  <p>2NU PK2</p> |  <p>2NU9 PK3</p> |  <p>2NU9-L PK4</p> |  <p>2OU PK4</p> |  <p>DU PK5</p> |
|  <p>7NU-S PK5</p> | | | | | |
| | | | | | |
| | | | | | |
| | | | | | |
| | | | | | |
| | | | | | |

美制螺纹NPSM接头 NPSM Fittings

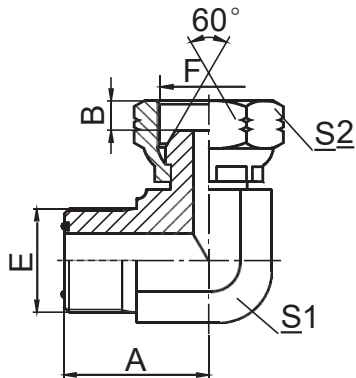

2FU9

90° ORFS外螺纹 / 美制NPSM内螺纹60° 外锥
90° ORFS MALE / NPSM FEMALE 60° CONE

| 代号 PART NO. | 螺 纹 THREAD | | O形圈 O-RING | | 尺 寸 DIMENSIONS | | | | |
|----------------|-------------|-------------|------------|--|----------------|------|----|----|--|
| | E | F | E端 | | A | B | S1 | S2 | |
| 2FU9-04 | 9/16"X18 | 1/4"X18 | O011 | | 23 | 4.6 | 14 | 19 | |
| 2FU9-04-06 | 9/16"X18 | 3/8"X18 | O011 | | 23 | 6 | 14 | 22 | |
| 2FU9-04-08 | 9/16"X18 | 1/2"X14 | O011 | | 25.5 | 7.5 | 19 | 27 | |
| 2FU9-06 | 11/16"X16 | 3/8"X18 | O012 | | 27.5 | 6 | 19 | 22 | |
| 2FU9-06-08 | 11/16"X16 | 1/2"X14 | O012 | | 27.5 | 7.5 | 19 | 27 | |
| 2FU9-06-12 | 11/16"X16 | 3/4"X14 | O012 | | 30.5 | 8.9 | 24 | 32 | |
| 2FU9-08 | 13/16"X16 | 1/2"X14 | O014 | | 31 | 7.5 | 22 | 27 | |
| 2FU9-08-12 | 13/16"X16 | 3/4"X14 | O014 | | 33 | 8.9 | 24 | 32 | |
| 2FU9-08-16 | 13/16"X16 | 1"X11.5 | O014 | | 36 | 10.5 | 30 | 41 | |
| 2FU9-10-12 | 1"X14 | 3/4"X14 | O016 | | 36.5 | 8.9 | 27 | 32 | |
| 2FU9-12 | 1.3/16"X12 | 3/4"X14 | O018 | | 41 | 8.9 | 30 | 32 | |
| 2FU9-12-16 | 1.3/16"X12 | 1"X11.5 | O018 | | 41 | 10.5 | 30 | 41 | |
| 2FU9-12-20 | 1.3/16"X12 | 1.1/4"X11.5 | O018 | | 46.5 | 11.2 | 41 | 50 | |
| 2FU9-16 | 1.7/16"X12 | 1"X11.5 | O021 | | 44.5 | 10.5 | 36 | 41 | |
| 2FU9-16-20 | 1.7/16"X12 | 1.1/4"X11.5 | O021 | | 47.5 | 11.2 | 41 | 50 | |
| 2FU9-16-24 | 1.7/16"X12 | 1.1/2"X11.5 | O021 | | 51.5 | 11.2 | 48 | 55 | |
| 2FU9-20 | 1.11/16"X12 | 1.1/4"X11.5 | O025 | | 47.5 | 11.2 | 41 | 50 | |
| 2FU9-20-24 | 1.11/16"X12 | 1.1/2"X11.5 | O025 | | 51.5 | 11.2 | 48 | 55 | |
| 2FU9-24 | 2"X12 | 1.1/2"X11.5 | O029 | | 53.5 | 11.2 | 50 | 55 | |

K

美制螺纹NPSM接头 NPSM Fittings

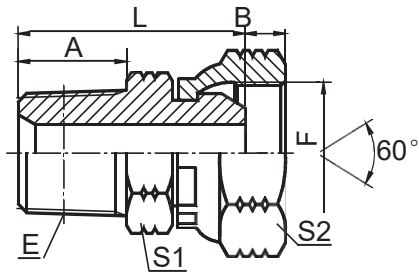

2NU

布锥管外螺纹 / 美制NPSM内螺纹60° 外锥
NPT MALE / NPSM FEMALE 60° CONE

| 代号 PART NO. | 螺 纹 THREAD | | 尺 寸 DIMENSIONS | | | | | | |
|----------------|--------------|-------------|----------------|--|------|------|------|----|----|
| | E | F | | | A | B | L | S1 | S2 |
| 2NU-02 | Z1/8"X27 | 1/8"X27 | | | 10.5 | 3.5 | 25.5 | 12 | 15 |
| 2NU-02-04 | Z1/8"X27 | 1/4"X18 | | | 10.5 | 4.6 | 27.5 | 12 | 19 |
| 2NU-04-02 | Z1/4"X18 | 1/8"X27 | | | 15 | 3.5 | 30 | 14 | 15 |
| 2NU-04 | Z1/4"X18 | 1/4"X18 | | | 15 | 4.6 | 32 | 17 | 19 |
| 2NU-04-06 | Z1/4"X18 | 3/8"X18 | | | 15 | 6 | 33 | 17 | 22 |
| 2NU-04-08 | Z1/4"X18 | 1/2"X14 | | | 15 | 7.5 | 35 | 19 | 27 |
| 2NU-06 | Z3/8"X18 | 3/8"X18 | | | 16 | 6 | 34.5 | 19 | 22 |
| 2NU-06-04 | Z3/8"X18 | 1/4"X18 | | | 16 | 4.6 | 33 | 19 | 19 |
| 2NU-06-08 | Z3/8"X18 | 1/2"X14 | | | 16 | 7.5 | 36 | 19 | 27 |
| 2NU-08 | Z1/2"X14 | 1/2"X14 | | | 19.5 | 7.5 | 41.5 | 22 | 27 |
| 2NU-08-04 | Z1/2"X14 | 1/4"X18 | | | 19.5 | 4.6 | 38.5 | 22 | 19 |
| 2NU-08-06 | Z1/2"X14 | 3/8"X18 | | | 19.5 | 6 | 39.5 | 22 | 22 |
| 2NU-12 | Z3/4"X14 | 3/4"X14 | | | 19.5 | 8.9 | 44.5 | 30 | 32 |
| 2NU-12-06 | Z3/4"X14 | 3/8"X18 | | | 19.5 | 6 | 41.5 | 30 | 22 |
| 2NU-12-08 | Z3/4"X14 | 1/2"X14 | | | 19.5 | 7.5 | 43.5 | 30 | 27 |
| 2NU-12-16 | Z3/4"X14 | 1"X11.5 | | | 19.5 | 10.5 | 46.5 | 32 | 41 |
| 2NU-16-12 | Z1"X11.5 | 3/4"X14 | | | 21.5 | 8.9 | 51.5 | 36 | 32 |
| 2NU-16 | Z1"X11.5 | 1"X11.5 | | | 25.5 | 10.5 | 52.5 | 36 | 41 |
| 2NU-16-20 | Z1"X11.5 | 1.1/4"X11.5 | | | 25.5 | 11.2 | 58.5 | 41 | 50 |
| 2NU-20-16 | Z1.1/4"X11.5 | 1"X11.5 | | | 26.5 | 10.5 | 55.5 | 36 | 41 |
| 2NU-20 | Z1.1/4"X11.5 | 1.1/4"X11.5 | | | 26.5 | 11.2 | 59.5 | 46 | 50 |
| 2NU-20-24 | Z1.1/4"X11.5 | 1.1/2"X11.5 | | | 26.5 | 11.2 | 59.5 | 46 | 55 |
| 2NU-24-20 | Z1.1/2"X11.5 | 1.1/4"X11.5 | | | 27.5 | 11.2 | 62.5 | 50 | 50 |
| 2NU-24 | Z1.1/2"X11.5 | 1.1/2"X11.5 | | | 27.5 | 11.2 | 62.5 | 50 | 55 |
| 2NU-32 | Z2"X11.5 | 2"X11.5 | | | 27.5 | 11.2 | 64.5 | 65 | 70 |

美制螺纹NPSM接头 NPSM Fittings

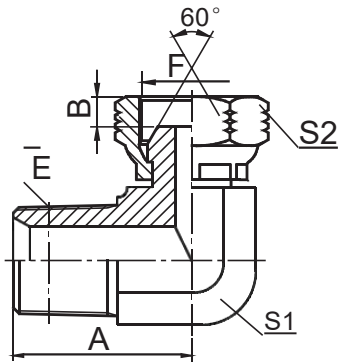

2NU9

90° 弯布锥管外螺纹 / 美制NPSM内螺纹60° 外锥
 90° ELBOW NPT MALE / NPSM FEMALE 60° CONE

| 代号 PART NO. | 螺 纹 THREAD | | 尺 寸 DIMENSIONS | | | | | | |
|----------------|--------------|-------------|----------------|--|------|------|----|----|--|
| | E | F | | | A | B | S1 | S2 | |
| 2NU9-02 | Z1/8"X27 | 1/8"X27 | | | 21 | 3.5 | 11 | 15 | |
| 2NU9-02-04 | Z1/8"X27 | 1/4"X18 | | | 21 | 4.6 | 11 | 19 | |
| 2NU9-04-02 | Z1/4"X18 | 1/8"X27 | | | 25.5 | 3.5 | 14 | 15 | |
| 2NU9-04 | Z1/4"X18 | 1/4"X18 | | | 25.5 | 4.6 | 14 | 19 | |
| 2NU9-04-06 | Z1/4"X18 | 3/8"X18 | | | 25.5 | 6 | 14 | 22 | |
| 2NU9-06 | Z3/8"X18 | 3/8"X18 | | | 31 | 6 | 19 | 22 | |
| 2NU9-06-04 | Z3/8"X18 | 1/4"X18 | | | 31 | 4.6 | 19 | 19 | |
| 2NU9-06-08 | Z3/8"X18 | 1/2"X14 | | | 31 | 7.5 | 19 | 27 | |
| 2NU9-08 | Z1/2"X14 | 1/2"X14 | | | 37.3 | 7.5 | 22 | 27 | |
| 2NU9-08-06 | Z1/2"X14 | 3/8"X18 | | | 36.7 | 6 | 22 | 22 | |
| 2NU9-08-12 | Z1/2"X14 | 3/4"X14 | | | 37.5 | 8.9 | 24 | 32 | |
| 2NU9-12 | Z3/4"X14 | 3/4"X14 | | | 44 | 8.9 | 27 | 32 | |
| 2NU9-12-08 | Z3/4"X14 | 1/2"X14 | | | 44 | 7.5 | 27 | 27 | |
| 2NU9-12-16 | Z3/4"X14 | 1"X11.5 | | | 45 | 10.5 | 30 | 41 | |
| 2NU9-16 | Z1"X11.5 | 1"X11.5 | | | 50 | 10.5 | 33 | 41 | |
| 2NU9-16-12 | Z1"X11.5 | 3/4"X14 | | | 50 | 8.9 | 33 | 32 | |
| 2NU9-20-16 | Z1.1/4"X11.5 | 1"X11.5 | | | 54.5 | 10.5 | 41 | 41 | |
| 2NU9-20 | Z1.1/4"X11.5 | 1.1/4"X11.5 | | | 54.5 | 11.2 | 41 | 50 | |
| 2NU9-24 | Z1.1/2"X11.5 | 1.1/2"X11.5 | | | 59.5 | 11.2 | 48 | 55 | |
| 2NU9-32 | Z2"X11.5 | 2"X11.5 | | | 73.5 | 11.2 | 63 | 70 | |

K

美制螺纹NPSM接头 NPSM Fittings

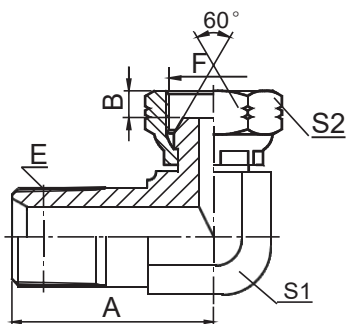

2NU9-L

90° 加长布锥管外螺纹 / 美制NPSM内螺纹60° 外锥
 90° LONG NPT MALE / NPSM FEMALE 60° CONE

| 代号 PART NO. | 螺 纹 THREAD | | 尺 寸 DIMENSIONS | | | | |
|----------------|--------------|-------------|----------------|------|----|----|--|
| | E | F | A | B | S1 | S2 | |
| 2NU9-04L | Z1/4"X18 | 1/4"X18 | 40.1 | 4.6 | 14 | 19 | |
| 2NU9-06L | Z3/8"X18 | 3/8"X18 | 46.2 | 6 | 19 | 22 | |
| 2NU9-08L | Z1/2"X14 | 1/2"X14 | 55.1 | 7.5 | 22 | 27 | |
| 2NU9-12L | Z3/4"X14 | 3/4"X14 | 62 | 8.9 | 27 | 32 | |
| 2NU9-16L | Z1"X11.5 | 1"X11.5 | 76.5 | 10.5 | 33 | 41 | |
| 2NU9-20L | Z1.1/4"X11.5 | 1.1/4"X11.5 | 93.7 | 11.2 | 41 | 50 | |
| 2NU9-24L | Z1.1/2"X11.5 | 1.1/2"X11.5 | 104.1 | 11.2 | 48 | 55 | |
| 2NU9-32L | Z2"X11.5 | 2"X11.5 | 122.2 | 11.2 | 63 | 70 | |

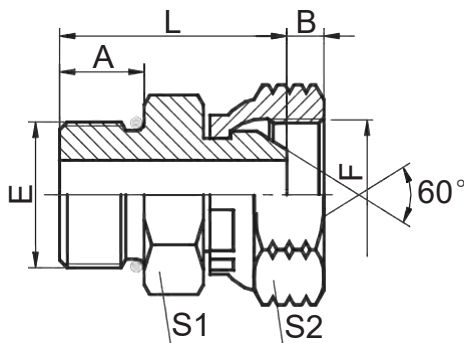

2OU

SAE外螺纹带O形圈轻系列ISO 11926-3 /
 美制NPSM内螺纹60° 外锥
 SAE O-RING BOSS L-SERIES ISO 11926-3 /
 NPSM FEMALE 60° CONE

| 代号 PART NO. | 螺 纹 THREAD | | O形圈 O-RING | 尺 寸 DIMENSIONS | | | | |
|----------------|------------|-------------|------------|----------------|------|------|----|----|
| | E | F | E端 | A | B | L | S1 | S2 |
| 2OU-04 | 7/16"X20 | 1/4"X18 | O904 | 9.1 | 4.6 | 26 | 14 | 19 |
| 2OU-04-06 | 7/16"X20 | 3/8"X18 | O904 | 9.1 | 6 | 27.5 | 17 | 22 |
| 2OU-06 | 9/16"X18 | 3/8"X18 | O906 | 9.9 | 6 | 28.5 | 17 | 22 |
| 2OU-06-08 | 9/16"X18 | 1/2"X14 | O906 | 9.9 | 7.5 | 30 | 19 | 27 |
| 2OU-08 | 3/4"X16 | 1/2"X14 | O908 | 11.1 | 7.5 | 33 | 22 | 27 |
| 2OU-08-06 | 3/4"X16 | 3/8"X18 | O908 | 11.1 | 6 | 31 | 22 | 22 |
| 2OU-10-08 | 7/8"X14 | 1/2"X14 | O910 | 12.7 | 7.5 | 36.5 | 27 | 27 |
| 2OU-12-08 | 1.1/16"X12 | 1/2"X14 | O912 | 15.1 | 7.5 | 40 | 32 | 27 |
| 2OU-12 | 1.1/16"X12 | 3/4"X14 | O912 | 15.1 | 8.9 | 41 | 32 | 32 |
| 2OU-12-16 | 1.1/16"X12 | 1"X11.5 | O912 | 15.1 | 10.5 | 42.5 | 32 | 41 |
| 2OU-16 | 1.5/16"X12 | 1"X11.5 | O916 | 15.1 | 10.5 | 42.5 | 38 | 41 |
| 2OU-20 | 1.5/8"X12 | 1.1/4"X11.5 | O920 | 15.1 | 11.2 | 50 | 50 | 50 |
| 2OU-24 | 1.7/8"X12 | 1.1/2"X11.5 | O924 | 15.1 | 11.2 | 50 | 55 | 55 |

美制螺纹NPSM接头 NPSM Fittings

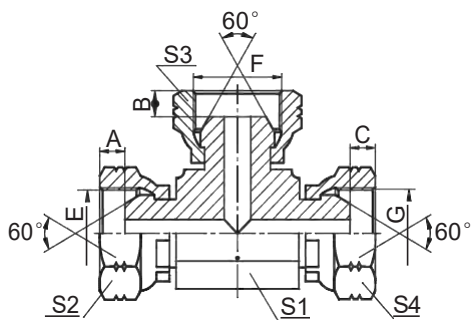

DU

美制NPSM内螺纹 / 美制
NPSM内螺纹 / 美制NPSM内螺纹
NPSM FEMALE / NPSM FEMALE /
NPSM FEMALE

| 代号 PART NO. | 螺 纹 THREAD | | | 尺 寸 DIMENSIONS | | | | | | |
|----------------|-------------|-------------|-------------|----------------|------|------|----|----|----|----|
| | E | F | G | A | B | C | S1 | S2 | S3 | S4 |
| DU-02 | 1/8"X27 | 1/8"X27 | 1/8"X27 | 3.5 | 3.5 | 3.5 | 11 | 15 | 15 | 15 |
| DU-04 | 1/4"X18 | 1/4"X18 | 1/4"X18 | 4.6 | 4.6 | 4.6 | 11 | 19 | 19 | 19 |
| DU-06 | 3/8"X18 | 3/8"X18 | 3/8"X18 | 6 | 6 | 6 | 14 | 22 | 22 | 22 |
| DU-08 | 1/2"X14 | 1/2"X14 | 1/2"X14 | 7.5 | 7.5 | 7.5 | 19 | 27 | 27 | 27 |
| DU-12 | 3/4"X14 | 3/4"X14 | 3/4"X14 | 8.9 | 8.9 | 8.9 | 24 | 32 | 32 | 32 |
| DU-16 | 1"X11.5 | 1"X11.5 | 1"X11.5 | 10.5 | 10.5 | 10.5 | 30 | 41 | 41 | 41 |
| DU-20 | 1.1/4"X11.5 | 1.1/4"X11.5 | 1.1/4"X11.5 | 11.2 | 11.2 | 11.2 | 41 | 50 | 50 | 50 |
| DU-24 | 1.1/2"X11.5 | 1.1/2"X11.5 | 1.1/2"X11.5 | 11.2 | 11.2 | 11.2 | 48 | 55 | 55 | 55 |

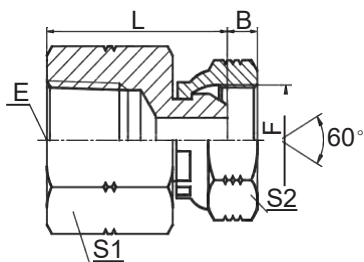

7NU-S

布锥管内螺纹 / 美制NPSM内螺纹60° 外锥
NPT FEMALE / NPSM FEMALE 60° CONE

| 代号 PART NO. | 螺 纹 THREAD | | 尺 寸 DIMENSIONS | | | | | | |
|----------------|--------------|-------------|----------------|--|------|------|----|----|--|
| | E | F | | | B | L | S1 | S2 | |
| 7NU-02S | Z1/8"X27 | 1/8"X27 | | | 3.5 | 24 | 17 | 15 | |
| 7NU-04-02S | Z1/4"X18 | 1/8"X27 | | | 3.5 | 29 | 19 | 15 | |
| 7NU-04S | Z1/4"X18 | 1/4"X18 | | | 4.6 | 31.5 | 19 | 19 | |
| 7NU-04-06S | Z1/4"X18 | 3/8"X18 | | | 6 | 33 | 19 | 22 | |
| 7NU-06S | Z3/8"X18 | 3/8"X18 | | | 6 | 34 | 22 | 22 | |
| 7NU-06-08S | Z3/8"X18 | 1/2"X14 | | | 7.5 | 34 | 22 | 27 | |
| 7NU-08-06S | Z1/2"X14 | 3/8"X18 | | | 6 | 39 | 30 | 22 | |
| 7NU-08S | Z1/2"X14 | 1/2"X14 | | | 7.5 | 41 | 30 | 27 | |
| 7NU-12S | Z3/4"X14 | 3/4"X14 | | | 8.9 | 44 | 36 | 32 | |
| 7NU-16S | Z1"X11.5 | 1"X11.5 | | | 10.5 | 51.5 | 41 | 41 | |
| 7NU-20S | Z1.1/4"X11.5 | 1.1/4"X11.5 | | | 11.2 | 55 | 50 | 50 | |
| 7NU-24S | Z1.1/2"X11.5 | 1.1/2"X11.5 | | | 11.2 | 55.5 | 60 | 55 | |
| 7NU-32S | Z2"X11.5 | 2"X11.5 | | | 11.5 | 57 | 70 | 70 | |

K

型号索引 Part NO. Index

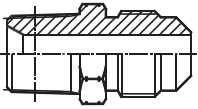
| | | | | | |
|---|--|--|--|--|--|
|  1NP PL1 | | | | | |
| | | | | | |
| | | | | | |
| | | | | | |
| | | | | | |
| | | | | | |
| | | | | | |
| | | | | | |

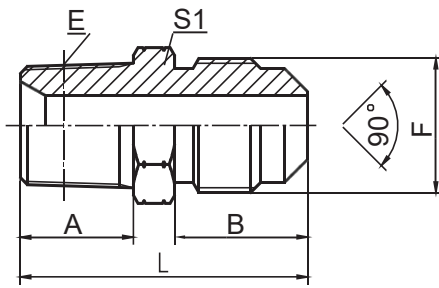

1NP

布锥管外螺纹 / SAE外螺纹90° 外锥
NPT MALE / SAE MALE 90° CONE

| 代号 PART NO. | 螺 纹 THREAD | | 尺 寸 DIMENSIONS | | | | | | |
|----------------|------------|------------|----------------|------|------|----|--|--|--|
| | E | F | A | B | L | S1 | | | |
| 1NP-04 | Z1/4"X18 | 7/16"X20 | 15 | 12.7 | 33.7 | 17 | | | |
| 1NP-04-05 | Z1/4"X18 | 1/2"X20 | 15 | 14.2 | 35.2 | 17 | | | |
| 1NP-04-06 | Z1/4"X18 | 5/8"X18 | 15 | 15.7 | 36.7 | 17 | | | |
| 1NP-06-04 | Z3/8"X18 | 7/16"X20 | 16 | 12.7 | 34.7 | 19 | | | |
| 1NP-06 | Z3/8"X18 | 5/8"X18 | 16 | 15.7 | 37.5 | 19 | | | |
| 1NP-06-08 | Z3/8"X18 | 3/4"X16 | 16 | 19 | 43 | 22 | | | |
| 1NP-08-06 | Z1/2"X14 | 5/8"X18 | 19.5 | 15.7 | 43.5 | 24 | | | |
| 1NP-08 | Z1/2"X14 | 3/4"X16 | 19.5 | 19 | 46.5 | 24 | | | |
| 1NP-08-10 | Z1/2"X14 | 7/8"X14 | 19.5 | 22.4 | 50 | 24 | | | |
| 1NP-12 | Z3/4"X14 | 1.1/16"X14 | 19.5 | 25.4 | 55 | 30 | | | |



法兰接头 Flange Fittings

法兰接头
Flange Fittings

M

型号索引 Part NO. Index

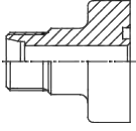
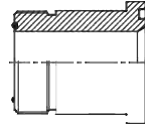
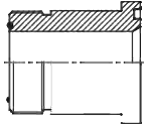
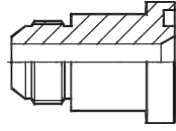
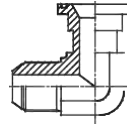
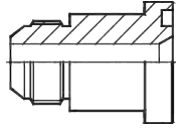
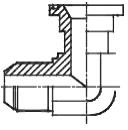
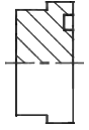
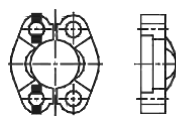
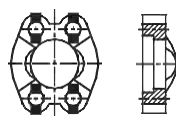
| | | | | | |
|---|---|---|--|--|---|
|  <p>1CFL-W, 1DFL-W, 1DFS-W PM1</p> |  <p>1FFL PM2</p> |  <p>1FFS PM2</p> |  <p>1JFL PM3</p> |  <p>1JFL9 PM3</p> |  <p>1JFS PM4</p> |
|  <p>1JFS9 PM5</p> |  <p>4FL, 4FS PM5</p> |  <p>FL, FS PM6</p> |  <p>FL-W, FS-W PM6</p> | | |
| | | | | | |
| | | | | | |
| | | | | | |
| | | | | | |
| | | | | | |

法兰接头 Flange Fittings

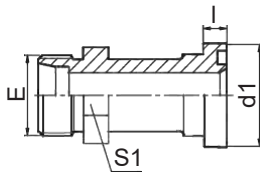

1CFL
1DFL

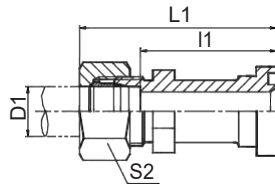

1CFL-RN
1DFL-RN

公制螺纹卡套式 / 轻
系列法兰ISO 6162-1
METRIC MALE BITE TYPE /
L-SERIES FLANGE ISO 6162-1

| 代号 PART NO. | 螺纹E THREAD | 法兰型号 FLANGE SIZE | 管子外径D1 TUBE O.D. | O形圈 O-RING | 尺寸 DIMENSIONS | | | | | | 压力等级 MPa |
|----------------|---------------|---------------------|---------------------|---------------|---------------|------|------|----|----|----|----------------|
| | | | | | d1 | l | l1 | L1 | S1 | S2 | |
| 1CFL-22-08 | M22X1.5 | 1/2" | 15 | O210 | 30.2 | 6.7 | 41 | 56 | 24 | 27 | 31.5 轻系列 L |
| 1CFL-26-12 | M26X1.5 | 3/4" | 18 | O214 | 38.1 | 6.73 | 45.5 | 62 | 30 | 32 | |
| 1CFL-30-12 | M30X2 | 3/4" | 22 | O214 | 38.1 | 6.7 | 45.5 | 62 | 32 | 36 | |
| 1CFL-36-16 | M36X2 | 1" | 28 | O219 | 44.4 | 8 | 46.5 | 63 | 38 | 41 | 16 轻系列 L |
| 1CFL-45-20 | M45X2 | 1.1/4" | 35 | O222 | 50.8 | 8 | 47.5 | 69 | 41 | 50 | |
| 1CFL-52-24 | M52X2 | 1.1/2" | 42 | O225 | 60.3 | 8 | 53 | 76 | 46 | 60 | |
| 1DFL-24-08 | M24X1.5 | 1/2" | 16 | O210 | 30.2 | 6.7 | 41.5 | 60 | 24 | 30 | 35 重系列 S |
| 1DFL-30-12 | M30X2 | 3/4" | 20 | O214 | 38.1 | 6.7 | 46.5 | 68 | 30 | 36 | |
| 1DFL-36-12 | M36X2 | 3/4" | 25 | O214 | 38.1 | 6.73 | 45 | 69 | 30 | 46 | |
| 1DFL-42-16 | M42X2 | 1" | 30 | O219 | 44.4 | 8 | 49.5 | 76 | 36 | 50 | |
| 1DFL-36-20 | M36X2 | 1.1/4" | 25 | O222 | 50.8 | 8 | 48 | 72 | 41 | 46 | 28 重系列 S |
| 1DFL-42-20 | M42X2 | 1.1/4" | 30 | O222 | 50.8 | 8 | 48.5 | 75 | 41 | 50 | |
| 1DFL-52-20 | M52X2 | 1.1/4" | 38 | O222 | 50.8 | 8 | 50 | 81 | 46 | 60 | |
| 1DFL-52-24 | M52X2 | 1.1/2" | 38 | O225 | 60.3 | 8 | 54 | 85 | 46 | 60 | |

注：如需带卡套及卡套螺母整套订货，则请在代号后加“RN”，如1DFL-52-24RN。 Note: In case if you are interested to order the adapter in complete set with cutting ring and nut, it is necessary to insert suffix "RN" after our part NO., for example 1DFL-52-24RN.

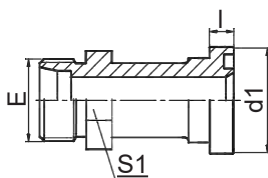

1DFS

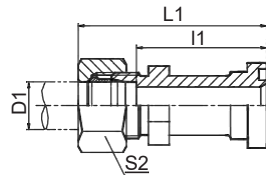

1DFS-RN

公制螺纹卡套式 / 重
系列法兰ISO 6162-2
METRIC MALE BITE TYPE /
H-SERIES FLANGE ISO 6162-2



| 代号 PART NO. | 螺纹E THREAD | 法兰型号 FLANGE SIZE | 管子外径D1 TUBE O.D. | O形圈 O-RING | 尺寸 DIMENSIONS | | | | | | 压力等级 MPa |
|----------------|---------------|---------------------|---------------------|---------------|---------------|------|------|-----|----|----|----------------|
| | | | | | d1 | l | l1 | L1 | S1 | S2 | |
| 1DFS-24-08 | M24X1.5 | 1/2" | 16 | O210 | 31.7 | 7.8 | 44.5 | 63 | 24 | 30 | 40 重系列 S |
| 1DFS-24-12 | M24X1.5 | 3/4" | 16 | O214 | 41.3 | 8.8 | 50.5 | 69 | 30 | 30 | |
| 1DFS-30-12 | M30X2 | 3/4" | 20 | O214 | 41.3 | 8.8 | 50.5 | 72 | 30 | 36 | |
| 1DFS-36-12 | M36X2 | 3/4" | 25 | O214 | 41.3 | 8.8 | 51 | 75 | 30 | 46 | |
| 1DFS-36-16 | M36X2 | 1" | 25 | O219 | 47.6 | 9.5 | 60 | 81 | 36 | 46 | |
| 1DFS-42-16 | M42X2 | 1" | 30 | O219 | 47.6 | 9.5 | 60.5 | 87 | 36 | 50 | |
| 1DFS-42-20 | M42X2 | 1.1/4" | 30 | O222 | 54 | 10.3 | 65.5 | 92 | 41 | 50 | |
| 1DFS-52-20 | M52X2 | 1.1/4" | 38 | O222 | 54 | 10.3 | 67 | 98 | 46 | 60 | 31.5 重系列S |
| 1DFS-52-24 | M52X2 | 1.1/2" | 38 | O225 | 63.5 | 12.6 | 73 | 104 | 46 | 60 | |

注：如需带卡套及卡套螺母整套订货，则请在代号后加“RN”，如1DFS-52-24RN。 Note: In case if you are interested to order the adapter in complete set with cutting ring and nut, it is necessary to insert suffix "RN" after our part NO., for example 1DFS-52-24RN.

法兰接头 Flange Fittings

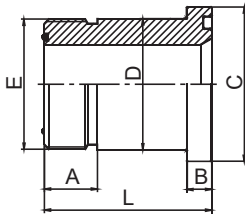

1FFL

美制ORFS外螺纹O形圈平面
密封 / 轻系列法兰ISO 6162-1
ORFS MALE O-RING /
L-SERIES FLANGE ISO 6162-1

| 代号 PART NO. | 螺纹THREAD | | 法兰型号 FLANGE SIZE | O形圈 O-RING | | 尺寸 DIMENSIONS | | | | |
|----------------|-------------|--|---------------------|------------|-----------|---------------|------|------|------|------|
| | E | | | E端 | 法兰端FLANGE | A | B | C | D | L |
| 1FFL-12 | 1.3/16X12 | | 3/4" | O018 | O214 | 17 | 6.73 | 38.1 | 31.7 | 45.7 |
| 1FFL-16 | 1.7/16"X12 | | 1" | O021 | O219 | 17.5 | 8 | 44.4 | 38 | 47.8 |
| 1FFL-20 | 1.11/16"X12 | | 1.1/4" | O025 | O222 | 17.5 | 8 | 50.8 | 43 | 47 |
| 1FFL-24 | 2"X12 | | 1.1/2" | O029 | O225 | 17.5 | 8 | 60.3 | 50 | 49.5 |

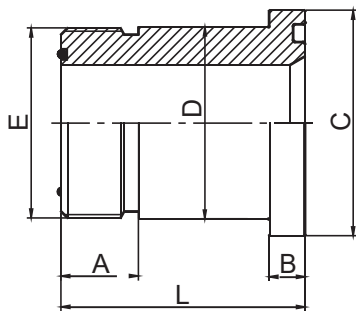

1FFS

美制ORFS外螺纹O形圈平面
密封 / 重系列法兰ISO 6162-2
ORFS MALE O-RING /
S-SERIES FLANGE ISO 6162-2

| 代号 PART NO. | 螺纹THREAD | | 法兰型号 FLANGE SIZE | O形圈 O-RING | | 尺寸 DIMENSIONS | | | | |
|----------------|-------------|--|---------------------|------------|-----------|---------------|-------|------|----|------|
| | E | | | E端 | 法兰端FLANGE | A | B | C | D | L |
| 1FFS-12 | 1.3/16X12 | | 3/4" | O018 | O214 | 17 | 8.76 | 41.3 | 32 | 51.8 |
| 1FFS-16 | 1.7/16"X12 | | 1" | O021 | O219 | 17.5 | 9.53 | 47.6 | 38 | 57.2 |
| 1FFS-20 | 1.11/16"X12 | | 1.1/4" | O025 | O222 | 17.5 | 10.29 | 54 | 44 | 62 |
| 1FFS-24 | 2"X12 | | 1.1/2" | O029 | O225 | 17.5 | 12.57 | 63.5 | 51 | 66.8 |

法兰接头 Flange Fittings

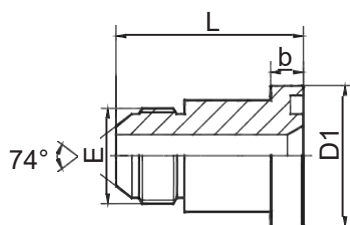

1JFL

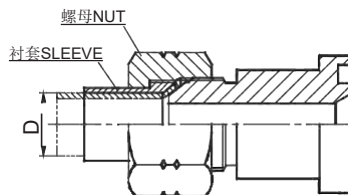

美制JIC外螺纹74° 外锥 / 轻系列法兰ISO 6162-1
JIC MALE 74° CONE / L-SERIES FLANGE ISO 6162-1

| 代号 PART NO. | 螺纹THREAD | | 法兰型号 FLANGE SIZE | O形圈 O-RING | 尺寸 DIMENSIONS | | | |
|----------------|------------|--|---------------------|---------------|---------------|------|---|------|
| | E | | | | b | D1 | L | |
| 1JFL-08 | 3/4"X16 | | 1/2" | O210 | 6.73 | 30.2 | | 43.5 |
| 1JFL-08-12 | 3/4"X16 | | 3/4" | O214 | 6.73 | 38.1 | | 45.4 |
| 1JFL-10-08 | 7/8"X14 | | 1/2" | O210 | 6.73 | 30.2 | | 48 |
| 1JFL-10-12 | 7/8"X14 | | 3/4" | O214 | 6.73 | 38.1 | | 48 |
| 1JFL-12-08 | 1.1/16"X12 | | 1/2" | O210 | 6.73 | 30.2 | | 49 |
| 1JFL-12 | 1.1/16"X12 | | 3/4" | O214 | 6.73 | 38.1 | | 50.5 |
| 1JFL-12-16 | 1.1/16"X12 | | 1" | O219 | 8 | 44.4 | | 52.2 |
| 1JFL-16-12 | 1.5/16"X12 | | 3/4" | O214 | 6.73 | 38.1 | | 52 |
| 1JFL-16 | 1.5/16"X12 | | 1" | O219 | 8 | 44.4 | | 53.4 |
| 1JFL-16-20 | 1.5/16"X12 | | 1.1/4" | O222 | 8 | 50.8 | | 52.2 |
| 1JFL-20-16 | 1.5/8"X12 | | 1" | O219 | 8 | 44.4 | | 54.5 |
| 1JFL-20 | 1.5/8"X12 | | 1.1/4" | O222 | 8 | 50.8 | | 53.1 |
| 1JFL-20-24 | 1.5/8"X12 | | 1.1/2" | O225 | 8 | 60.3 | | 56 |
| 1JFL-24-20 | 1.7/8"X12 | | 1.1/4" | O222 | 8 | 50.8 | | 56.5 |
| 1JFL-24 | 1.7/8"X12 | | 1.1/2" | O225 | 8 | 60.3 | | 59.2 |
| 1JFL-24-32 | 1.7/8"X12 | | 2" | O228 | 9.53 | 71.4 | | 60 |
| 1JFL-32 | 2.1/2"X12 | | 2" | O228 | 9.53 | 71.4 | | 66.3 |

注：螺母及衬套需另行订货。管子直径D为公制时，配用螺母及衬套分别选用NB200、NB500。管子直径为英制时，配用螺母及衬套分别选用NB200、NB300。 Note: Nut and sleeve should be ordered separately. The nut NB200 and sleeve NB500 is suitable for metric tube, the nut NB200 and sleeve NB300 is suitable for inch tube.

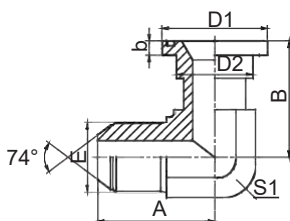

1JFL9

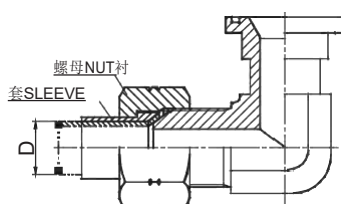

90° 弯美制JIC外螺纹74° 外锥 / 轻系列法兰ISO 6162-1

90° ELBOW JIC MALE 74° CONE / L-SERIES FLANGE ISO 6162-1

| 代号 PART NO. | 螺纹THREAD | | 法兰型号 FLANGE SIZE | O形圈 O-RING | 尺寸 DIMENSIONS | | | | | |
|----------------|------------|--|---------------------|---------------|---------------|------|------|------|------|----|
| | E | | | | A | B | b | D1 | D2 | S1 |
| 1JFL9-08 | 3/4"X16 | | 1/2" | O210 | 32.5 | 44 | 6.73 | 30.2 | 24 | 19 |
| 1JFL9-08-12 | 3/4"X16 | | 3/4" | O214 | 38 | 54.1 | 6.73 | 38.1 | 31.7 | 27 |
| 1JFL9-10-08 | 7/8"X14 | | 1/2" | O210 | 37.5 | 44 | 6.73 | 30.2 | 24 | 22 |
| 1JFL9-10-12 | 7/8"X14 | | 3/4" | O214 | 41 | 54.1 | 6.73 | 38.1 | 31.7 | 27 |
| 1JFL9-12 | 1.1/16"X12 | | 3/4" | O214 | 44.5 | 54.1 | 6.73 | 38.1 | 31.7 | 27 |
| 1JFL9-12-16 | 1.1/16"X12 | | 1" | O219 | 48 | 60.2 | 8 | 44.4 | 38 | 33 |
| 1JFL9-16 | 1.5/16"X12 | | 1" | O219 | 49 | 60.2 | 8 | 44.4 | 38 | 33 |
| 1JFL9-16-12 | 1.5/16"X12 | | 3/4" | O214 | 49 | 58 | 6.73 | 38.1 | 31.7 | 33 |
| 1JFL9-16-20 | 1.5/16"X12 | | 1.1/4" | O222 | 54 | 66.5 | 8 | 50.8 | 43 | 41 |
| 1JFL9-20 | 1.5/8"X12 | | 1.1/4" | O222 | 55.5 | 66.5 | 8 | 50.8 | 43 | 41 |
| 1JFL9-20-16 | 1.5/8"X12 | | 1" | O219 | 55.5 | 65 | 8 | 44.4 | 38 | 41 |
| 1JFL9-20-24 | 1.5/8"X12 | | 1.1/2" | O225 | 60 | 79.3 | 8 | 60.3 | 50 | 48 |
| 1JFL9-24 | 1.7/8"X12 | | 1.1/2" | O225 | 62.5 | 79.3 | 8 | 60.3 | 50 | 48 |
| 1JFL9-24-20 | 1.7/8"X12 | | 1.1/4" | O222 | 62.5 | 75.5 | 8 | 50.8 | 43 | 48 |
| 1JFL9-24-32 | 1.7/8"X12 | | 2" | O228 | 74.5 | 108 | 9.53 | 71.4 | 62 | 63 |
| 1JFL9-32 | 2.1/2"X12 | | 2" | O228 | 80 | 108 | 9.53 | 71.4 | 62 | 63 |

注：螺母及衬套需另行订货。管子直径D为公制时，配用螺母及衬套分别选用NB200、NB500。管子直径为英制时，配用螺母及衬套分别选用NB200、NB300。 Note: Nut and sleeve should be ordered separately. The nut NB200 and sleeve NB500 is suitable for metric tube, the nut NB200 and sleeve NB300 is suitable for inch tube.

法兰接头 Flange Fittings

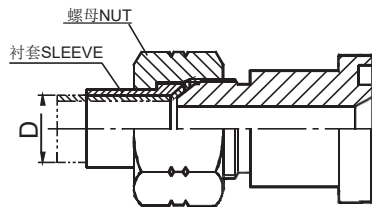
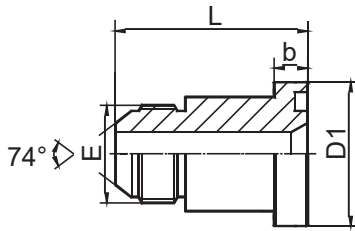

1JFS

美制JIC外螺纹74° 外锥 / 重系列法兰ISO 6162-2
JIC MALE 74° CONE / S-SERIES FLANGE ISO 6162-2

| 代号 PART NO. | 螺纹THREAD | | 法兰型号 FLANGE SIZE | O形圈 O-RING | 尺寸 DIMENSIONS | | | | |
|----------------|------------|--|---------------------|---------------|---------------|------|---|------|--|
| | E | | | | b | D1 | L | | |
| 1JFS-08 | 3/4"X16 | | 1/2" | O210 | 7.75 | 31.7 | | 47.5 | |
| 1JFS-10-08 | 7/8"X14 | | 1/2" | O210 | 7.75 | 31.7 | | 50 | |
| 1JFS-10-12 | 7/8"X14 | | 3/4" | O214 | 8.76 | 41.3 | | 55 | |
| 1JFS-12 | 1.1/16"X12 | | 3/4" | O214 | 8.76 | 41.3 | | 56.7 | |
| 1JFS-12-16 | 1.1/16"X12 | | 1" | O219 | 9.53 | 47.6 | | 61.5 | |
| 1JFS-16-12 | 1.5/16"X12 | | 3/4" | O214 | 8.76 | 41.3 | | 57.8 | |
| 1JFS-16 | 1.5/16"X12 | | 1" | O219 | 9.53 | 47.6 | | 62.8 | |
| 1JFS-16-20 | 1.5/16"X12 | | 1.1/4" | O222 | 10.29 | 54 | | 67.7 | |
| 1JFS-20-16 | 1.5/8"X12 | | 1" | O219 | 9.53 | 47.6 | | 64 | |
| 1JFS-20 | 1.5/8"X12 | | 1.1/4" | O222 | 10.29 | 54 | | 68.9 | |
| 1JFS-20-24 | 1.5/8"X12 | | 1.1/2" | O225 | 12.57 | 63.5 | | 73.5 | |
| 1JFS-24-20 | 1.7/8"X12 | | 1.1/4" | O222 | 10.29 | 54 | | 72 | |
| 1JFS-24 | 1.7/8"X12 | | 1.1/2" | O225 | 12.57 | 63.5 | | 76.7 | |

注：螺母及衬套需另行订货。管子直径D为公制时，配用螺母及衬套分别选用NB200、NB500。管子直径为英制时，配用螺母及衬套分别选用NB200、NB300。Note: Nut and sleeve should be ordered separately. The nut NB200 and sleeve NB500 is suitable for metric tube, the nut NB200 and sleeve NB300 is suitable for inch tube.

法兰接头 Flange Fittings

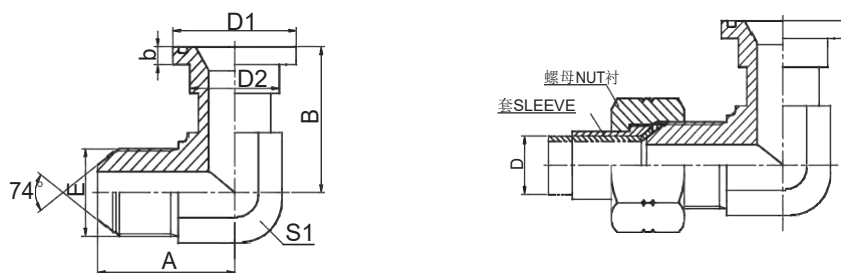

1JFS9 90° 弯美制JIC外螺纹74° 外锥 / 重系列法兰ISO 6162-2
90° ELBOW JIC MALE 74° CONE / S-SERIES FLANGE ISO 6162-2

| 代号 PART NO. | 螺纹 THREAD | | 法兰型号 FLANGE SIZE | O 形圈 O-RING | 尺寸 DIMENSIONS | | | | | |
|----------------|------------|--|---------------------|----------------|---------------|------|-------|------|----|----|
| | E | | | | A | B | b | D1 | D2 | S1 |
| 1JFS9-08 | 3/4"X16 | | 1/2" | O210 | 32.5 | 44 | 7.75 | 31.7 | 24 | 19 |
| 1JFS9-10-08 | 7/8"X14 | | 1/2" | O210 | 37.5 | 46 | 7.75 | 31.7 | 24 | 22 |
| 1JFS9-10-12 | 7/8"X14 | | 3/4" | O214 | 41 | 54.1 | 8.76 | 41.3 | 32 | 27 |
| 1JFS9-12 | 1.1/16"X12 | | 3/4" | O214 | 44.2 | 54.1 | 8.76 | 41.3 | 32 | 27 |
| 1JFS9-12-16 | 1.1/16"X12 | | 1" | O219 | 48 | 60.2 | 9.6 | 47.6 | 38 | 33 |
| 1JFS9-16 | 1.5/16"X12 | | 1" | O219 | 49 | 60.2 | 9.53 | 47.6 | 38 | 33 |
| 1JFS9-16-12 | 1.5/16"X12 | | 3/4" | O214 | 49 | 57 | 8.76 | 41.3 | 32 | 33 |
| 1JFS9-16-20 | 1.5/16"X12 | | 1.1/4" | O222 | 54 | 66.5 | 10.29 | 54 | 44 | 41 |
| 1JFS9-20 | 1.5/8"X12 | | 1.1/4" | O222 | 55.5 | 66.5 | 10.29 | 54 | 44 | 41 |
| 1JFS9-20-16 | 1.5/8"X12 | | 1" | O219 | 55.5 | 65 | 9.53 | 47.6 | 38 | 41 |
| 1JFS9-20-24 | 1.5/8"X12 | | 1.1/2" | O225 | 59.5 | 79.3 | 12.57 | 63.5 | 51 | 48 |
| 1JFS9-24 | 1.7/8"X12 | | 1.1/2" | O225 | 62.5 | 79.3 | 12.57 | 63.5 | 51 | 48 |
| 1JFS9-24-20 | 1.7/8"X12 | | 1.1/4" | O222 | 62.5 | 79 | 10.29 | 54 | 44 | 48 |

注：螺母及衬套需另行订货。管子直径D为公制时，配用螺母及衬套分别选用NB200、NB500。管子直径为英制时，配用螺母及衬套分别选用NB200、NB300。 Note: Nut and sleeve should be ordered separately. The nut NB200 and sleeve NB500 is suitable for metric tube, the nut NB200 and sleeve NB300 is suitable for inch tube.

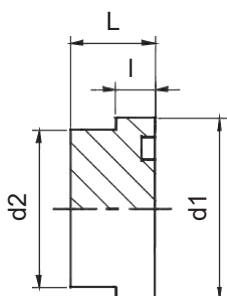

4FL
4FS

SAE 法兰堵头
SAE FLANGE PLUG

| 代号 PART NO. | 法兰型号 FLANGE SIZE | 尺寸 DIMENSIONS | | | | 压力等级 MPa |
|----------------|---------------------|---------------|------|----|------|-------------|
| | | d1 | d2 | L | l | |
| 3000PSI | | | | | | |
| 4FL-08 | 1/2" | 30.2 | 24 | 16 | 6.8 | 34.5 |
| 4FL-12 | 3/4" | 38.1 | 31.5 | 17 | 6.8 | |
| 4FL-16 | 1" | 44.4 | 38 | 17 | 8 | |
| 4FL-20 | 1.1/4" | 50.8 | 43 | 17 | 8 | 27.6 |
| 4FL-24 | 1.1/2" | 60.3 | 50 | 19 | 8 | 20.7 |
| 4FL-32 | 2" | 71.4 | 62 | 19 | 9.6 | |
| 4FL-40 | 2.1/2" | 84.1 | 74 | 40 | 9.6 | 17.2 |
| 4FL-48 | 3" | 101.6 | 90 | 45 | 9.6 | 13.8 |
| 4FL-56 | 3.1/2" | 114.3 | 102 | 30 | 11.3 | 3.4 |
| 4FL-64 | 4" | 127 | 114 | 36 | 11.3 | |
| 4FL-80 | 5" | 152.4 | 140 | 45 | 11.3 | |
| 6000PSI | | | | | | |
| 4FS-08 | 1/2" | 31.8 | 24 | 18 | 7.8 | 42 |
| 4FS-12 | 3/4" | 41.3 | 32 | 18 | 8.8 | |
| 4FS-16 | 1" | 47.6 | 38 | 18 | 9.5 | |
| 4FS-20 | 1.1/4" | 54 | 44 | 18 | 10.3 | |
| 4FS-24 | 1.1/2" | 63.5 | 51 | 20 | 12.6 | |
| 4FS-32 | 2" | 79.4 | 67 | 30 | 12.6 | |

M

法兰接头 Flange Fittings

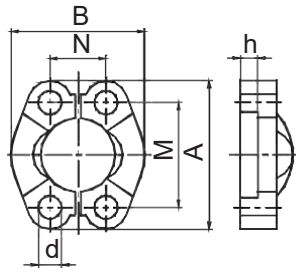

**FL
FS**

SAE 对开法兰夹
SAE SPLIT FLANGE CLAMP

| 代号 PART NO. | 法兰型号 FLANGE SIZE | 尺寸 DIMENSIONS | | | | | | | | 压力等级 MPa |
|----------------|---------------------|---------------|-----|-------|------|-----|-------|------|--------|-------------|
| | | A | B | d | h | M | N | | | |
| 3000PSI | | | | | | | | | | |
| FL-08 | 1/2" | | 54 | 45.6 | 9 | 6.2 | 38.1 | 17.5 | M8X25 | 34.5 |
| FL-12 | 3/4" | | 65 | 51.8 | 11 | 6.2 | 47.6 | 22.2 | M10X30 | |
| FL-16 | 1" | | 70 | 58.4 | 11 | 7.5 | 52.4 | 26.2 | M10X30 | |
| FL-20 | 1.1/4" | | 79 | 72.6 | 11 | 7.5 | 58.7 | 30.2 | M10X30 | 27.6 |
| FL-24 | 1.1/2" | | 94 | 82.2 | 13.5 | 7.5 | 69.9 | 35.7 | M12X35 | 20.7 |
| FL-32 | 2" | | 102 | 96.4 | 13.5 | 9 | 77.8 | 42.9 | M12X35 | |
| FL-40 | 2.1/2" | | 114 | 108.2 | 13.5 | 9 | 88.9 | 50.8 | M12X40 | 17.2 |
| FL-48 | 3" | | 135 | 130.6 | 17.5 | 9 | 106.4 | 61.9 | M16X50 | 13.8 |
| 6000PSI | | | | | | | | | | |
| FS-08 | 1/2" | | 56 | 47.2 | 9 | 7.2 | 40.5 | 18.2 | M8X30 | 42 |
| FS-12 | 3/4" | | 71 | 60 | 11 | 8.2 | 50.8 | 23.8 | M10X35 | |
| FS-16 | 1" | | 81 | 69.6 | 13.5 | 9 | 57.2 | 27.8 | M12X45 | |
| FS-20 | 1.1/4" | | 95 | 77.2 | 13.5 | 9.8 | 66.6 | 31.8 | M12X45 | |
| FS-24 | 1.1/2" | | 113 | 95 | 17.5 | 12 | 79.3 | 36.5 | M16X55 | |
| FS-32 | 2" | | 133 | 113.8 | 22 | 12 | 96.8 | 44.5 | M20X70 | |

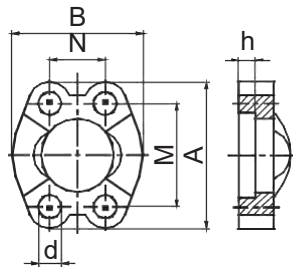

**FL-W
FS-W**

SAE法兰夹
SAE FLANGE CLAMP



| 代号 PART NO. | 法兰型号 FLANGE SIZE | 尺寸 DIMENSIONS | | | | | | | | 压力等级 MPa |
|----------------|---------------------|---------------|-----|-------|-------|-----|-------|------|--------|-------------|
| | | A | B | d | h | M | N | | | |
| 3000PSI | | | | | | | | | | |
| FL-08W | 1/2" | | 54 | 45.6 | 9 | 6.2 | 38.1 | 17.5 | M8X25 | 34.5 |
| FL-12W | 3/4" | | 65 | 51.8 | 11 | 6.2 | 47.6 | 22.2 | M10X30 | |
| FL-16W | 1" | | 70 | 58.4 | 11 | 7.5 | 52.4 | 26.2 | M10X30 | |
| FL-20W | 1.1/4" | | 79 | 72.6 | 11 | 7.5 | 58.7 | 30.2 | M10X30 | 27.6 |
| FL-24W | 1.1/2" | | 94 | 82.2 | 13.5 | 7.5 | 69.9 | 35.7 | M12X35 | 20.7 |
| FL-32W | 2" | | 102 | 96.4 | 13.5 | 9 | 77.8 | 42.9 | M12X35 | |
| FL-40W | 2.1/2" | | 114 | 108.2 | 13.5 | 9 | 88.9 | 50.8 | M12X40 | 17.2 |
| FL-48W | 3" | | 135 | 130.6 | 16.75 | 9 | 106.4 | 61.9 | M16X50 | 13.8 |
| 6000PSI | | | | | | | | | | |
| FS-08W | 1/2" | | 56 | 47.2 | 9 | 7.2 | 40.5 | 18.2 | M8X30 | 42 |
| FS-12W | 3/4" | | 71 | 60 | 11 | 8.2 | 50.8 | 23.8 | M10X35 | |
| FS-16W | 1" | | 81 | 69.9 | 13.5 | 9 | 57.2 | 27.8 | M12X45 | |
| FS-20W | 1.1/4" | | 95 | 77.2 | 13.5 | 9.8 | 66.6 | 31.8 | M14X50 | |
| FS-24W | 1.1/2" | | 113 | 95 | 17.5 | 12 | 79.3 | 36.5 | M16X55 | |
| FS-32W | 2" | | 133 | 113.8 | 22 | 12 | 96.8 | 44.5 | M20X70 | |



附加资料 Information

| | |
|---|------|
| 接头工作压力表 Working Pressure | N-1 |
| 油口型式及尺寸 Port Type And Dimension | N-3 |
| 接头概述及装配说明 Fittings and Fittings Assembly Instructions | N-10 |
| 硬管管路的正确布置 Routing of Tube Lines | N-15 |
| 螺纹扭矩建议表 Recommended Thread Torque | N-18 |
| 密封件 Seal | N-19 |
| 单位转换表 Conversion Factor | N-21 |
| 型号索引 Part NO. Index | N-22 |

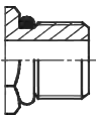
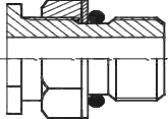
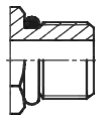
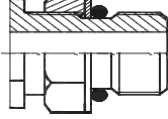
接头工作压力表 Working Pressure

压力单位为 PRESSURE UNIT MPa

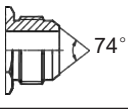

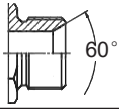
| 螺纹 Thread |  |  |  |  |  |  |
|--------------|---|---|---|--|---|---|
| | 公制外螺纹O形圈密封重系列 Metric Male O-Ring S-Series | 公制外螺纹O形圈密封可调柱端重系列 Metric Male O-Ring Adjustable Stud End S-Series | 公制外螺纹O形圈密封轻系列 Metric Male O-Ring L-Series | 公制外螺纹O形圈密封可调柱端轻系列 Metric Male O-Ring Adjustable Stud End L-Series | 公制外螺纹弹性密封柱端轻系列(E型) Metric Male Captive Seal L-Series | 公制外螺纹弹性密封柱端重系列(E型) Metric Male Captive Seal S-Series |
| M8X1 | 63 | 40 | 40 | 31.5 | - | - |
| M10X1 | 63 | 40 | 40 | 31.5 | 25 | - |
| M12X1.5 | 63 | 40 | 40 | 31.5 | 25 | 63 |
| M14X1.5 | 63 | 40 | 40 | 31.5 | 25 | 63 |
| M16X1.5 | 63 | 40 | 31.5 | 25 | 25 | 63 |
| M18X1.5 | 63 | 40 | 31.5 | 25 | 25 | 63 |
| M20X1.5 | - | - | - | - | - | 63 |
| M22X1.5 | - | - | - | - | 16 | 40 |
| M22X1.5 | 63 | 40 | 31.5 | 25 | - | - |
| M26X1.5 | - | - | - | - | 16 | - |
| M27X2 | 40 | 40 | 20 | 16 | - | 40 |
| M30X2 | 40 | 40 | 20 | 16 | - | - |
| M33X2 | - | - | - | - | 10 | 40 |
| M33X2 | 40 | 31.5 | 20 | 16 | - | - |
| M42X2 | 25 | 25 | 20 | 16 | - | - |
| M42X2 | - | - | - | - | 10 | 25 |
| M48X2 | 25 | 20 | 20 | 16 | 10 | 25 |
| M60X2 | 25 | 16 | 16 | 10 | - | - |

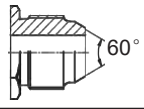
| 螺纹 Thread |  |  |  |
|--------------|---|---|---|
| | 公制外螺纹74°锥密封 Metric Male 74° Cone | 公制外螺纹O形圈密封 Metric Male O-Ring | 公制外螺纹60°锥密封 Metric Male 60° Cone Seat |
| M10X1 | 35 | - | - |
| M10X1 | 35 | - | - |
| M12X1.25 | - | 63 | - |
| M12X1.5 | 35 | - | - |
| M14X1.5 | 35 | 63 | 34.5 |
| M16X1.5 | 25 | 63 | - |
| M18X1.5 | 25 | 63 | 34.5 |
| M22X1.5 | 20 | 63 | 34.5 |
| M24X1.5 | 20 | - | - |
| M27X1.5 | 20 | 40 | - |
| M27X2 | - | - | 27.5 |
| M30X2 | 20 | - | - |
| M30X1.5 | - | 40 | - |
| M33X2 | 16 | - | 20.5 |
| M36X2 | 16 | - | - |
| M36X2 | - | 40 | - |
| M39X2 | 12.5 | - | - |
| M39X2 | - | 25 | - |
| M42X2 | 12.5 | - | 17 |
| M42X2 | - | 25 | - |
| M45X2 | 10 | - | - |
| M45X2 | - | 25 | - |
| M52X2 | - | 25 | - |
| M60X2 | - | 25 | - |
| M64X2 | - | 25 | - |

| 螺纹 Thread |  |
|--------------|---|
| | 日本公制外螺纹60°锥密封 JIS Metric Male 60° Cone |
| M12X1.5 | 34.5 |
| M14X1.5 | 34.5 |
| M16X1.5 | 34.5 |
| M18X1.5 | 34.5 |
| M20X1.5 | 34.5 |
| M22X1.5 | 34.5 |
| M24X1.5 | 27.5 |
| M27X1.5 | 27.5 |
| M30X1.5 | 20.5 |
| M33X1.5 | 20.5 |
| M36X1.5 | 17 |
| M42X1.5 | 17 |

N

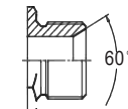
附加资料 Information

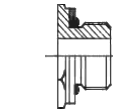
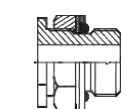
| 螺纹 Thread |  |  |  |  |
|--------------|---|---|---|---|
| | 英管外螺纹 60°锥面密封 BSP Male 60° Cone Seat | 日本英管外 螺纹60°锥面 密封 JIS GAS Male 60° Cone | 英管外螺纹O 形圈密封 BSP Male O-Ring | 英管外螺纹O 形圈密封可 调柱端 BSP Male O-Ring Adjustable Stud End |
| G1/8"X28 | 34.5 | 34.5 | 40 | 31.5 |
| G1/4"X19 | 34.5 | 34.5 | 40 | 31.5 |
| G3/8"X19 | 34.5 | 34.5 | 31.5 | 25 |
| G1/2"X14 | 34.5 | 34.5 | 31.5 | 25 |
| G3/4"X14 | 27.5 | 27.5 | 20 | 16 |
| G1"X11 | 20.5 | 20.5 | 20 | 16 |
| G1.1/4"X11 | 17 | 17 | 20 | 16 |
| G1.1/2"X11 | 10.5 | 10.5 | 20 | 16 |
| G2"X11 | 10.5 | 10.5 | 16 | 10 |

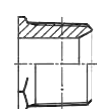
| 螺纹 Thread |  |
|--------------|---|
| | 英锥管外 螺纹 BSPT Male |
| R1/8"X28 | 34.5 |
| R1/4"X19 | 34.5 |
| R3/8"X19 | 34.5 |
| R1/2"X14 | 34.5 |
| R3/4"X14 | 27.5 |
| R1"X11 | 20.5 |
| R1.1/4"X11 | 17 |
| R1.1/2"X11 | 10.5 |
| R2"X11 | 10.5 |

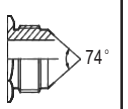
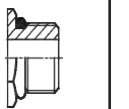
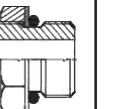
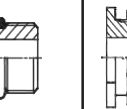
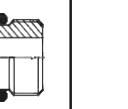
| 螺纹 Thread |  |  |  |  |  |
|--------------|---|---|---|---|--|
| | 美制JIC 74° 锥密封 JIC 74° Cone | 美制外螺纹O 形圈密封重系列 SAE Male O-Ring S-Series | 美制外螺纹O 形圈密封可调 柱端重系列 SAE Male O-Ring Adjustable Stud End S-Series | 美制外螺纹O 形圈密封轻系列 SAE Male O-Ring L-Series | 美制外螺纹O 形圈密封可调 柱端轻系列 Metric Male O-Ring Adjustable Stud End L-Series |
| 5/16"X24 | 34.5 | - | - | 31.5 | 31.5 |
| 3/8"X24 | 34.5 | 63 | 40 | 31.5 | 31.5 |
| 7/16"X20 | 34.5 | 63 | 40 | 31.5 | 31.5 |
| 1/2"X20 | 34.5 | 63 | 40 | 31.5 | 31.5 |
| 9/16"X18 | 34.5 | 63 | 40 | 31.5 | 25 |
| 3/4"X16 | 31 | 63 | 40 | 31.5 | 25 |
| 7/8"X14 | 24 | 63 | 40 | 25 | 20 |
| 1.1/16"X12 | 24 | 40 | 40 | 25 | 20 |
| 1.3/16"X12 | 21 | 40 | 40 | 20 | 16 |
| 1.5/16"X12 | 21 | 40 | 31.5 | 20 | 16 |
| 1.5/8"X12 | 17 | 25 | 25 | 16 | 12.5 |
| 1.7/8"X12 | 14 | 25 | 20 | 16 | 12.5 |
| 2.1/2"X12 | 10.5 | - | - | 12.5 | 10 |

| 螺纹 Thread |  |
|--------------|---|
| | 美制布锥管 外螺纹 NPT Male |
| Z1/8"X27 | 34.5 |
| Z1/4"X18 | 27.5 |
| Z3/8"X18 | 21 |
| Z1/2"X14 | 21 |
| Z3/4"X14 | 17 |
| Z1"X11.5 | 14 |
| Z1.1/4"X11.5 | 8 |
| Z1.1/2"X11.5 | 7 |

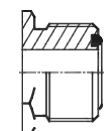
| 螺纹 Thread |  |
|--------------|---|
| | 美制ORFS外螺纹 O形圈密封 ORFS Male O-Ring |
| 9/16"X18 | 63 |
| 11/16"X16 | 63 |
| 13/16"X16 | 63 |
| 1"X14 | 40 |
| 1.3/16"X12 | 40 |
| 1.7/16"X12 | 40 |
| 1.11/16"X12 | 25 |
| 2"X12 | 25 |

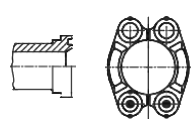
| SAE 法兰 规格 SAE Flange Size |  | | | |
|---------------------------------|---|--|--|--|
| | 使用中等强 度螺栓 轻系列 Mid-Strength Bolt L-Series | 使用高强度 螺栓 轻系列 High-Strength Bolt L-Series | 使用中等强 度螺栓 重系列 Mid-Strength Bolt S-Series | 使用高强度 螺栓 重系列 High-Strength Bolt S-Series |
| 1/2" | 35 | 35 | 35 | 40 |
| 3/4" | 35 | 35 | 35 | 40 |
| 1" | 25 | 31.5 | 35 | 40 |
| 1.1/4" | 20 | 25 | 35 | 40 |
| 1.1/2" | 20 | 20 | 35 | 40 |
| 2" | 16 | 16 | 35 | 40 |

油口型式及尺寸 Port Type And Dimension

1 ISO 9974-1公制螺纹油口及相配柱端 ISO 9974-1 metric thread port and mating stud end

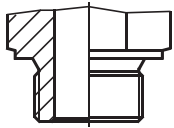

A型柱端
Type A

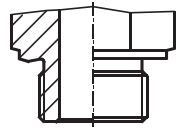

ISO 9974-3 B型柱端
ISO 9974-3 Type B

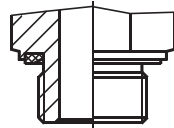

ISO 9974-2 E型柱端
ISO 9974-2 Type E

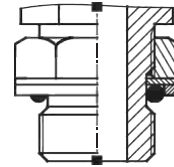

O形圈密封
O-Ring Seal

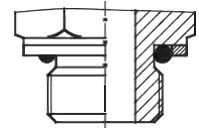

O形圈密封
O-Ring Seal

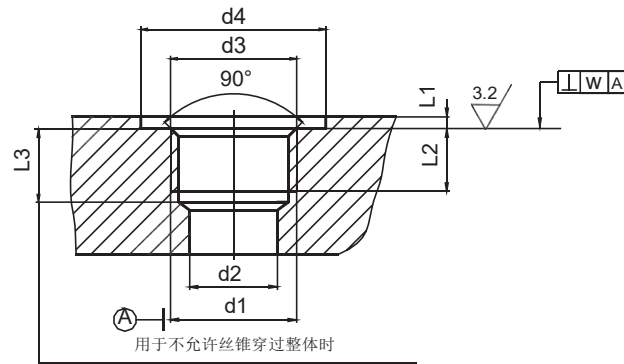

ISO 9974-1油口 ISO 9974-1 Port

油口尺寸 Port Dimensions mm

| 螺纹 Thread d1 | d2 参考ref. | d3 | | d4 min. | L1 max. | L2 min. | L3 min. | w |
|--------------------|--------------|--------|---------|------------|------------|------------|------------|-----|
| | | 尺寸nom. | 公差tol. | | | | | |
| M8X1 | 3 | 8 | 0, +0.2 | 13 | 1 | 8 | 10 | 0.1 |
| M10X1 | 4.5 | 10 | 0, +0.2 | 15 | 1 | 8 | 10 | 0.1 |
| M12X1.5 | 6 | 12 | 0, +0.2 | 18 | 1.5 | 12 | 15 | 0.1 |
| M14X1.5 | 7 | 14 | 0, +0.2 | 20 | 1.5 | 12 | 15 | 0.1 |
| M16X1.5 | 9 | 16 | 0, +0.2 | 23 | 1.5 | 12 | 15 | 0.1 |
| M18X1.5 | 11 | 18 | 0, +0.2 | 25 | 2 | 12 | 15 | 0.1 |
| M20X1.5 | 10 | 20 | 0, +0.2 | 27 | 2 | 14 | 17 | 0.1 |
| M22X1.5 | 14 | 22 | 0, +0.2 | 28 | 2.5 | 14 | 17 | 0.1 |
| M26X1.5 | 18 | 26 | 0, +0.2 | 33 | 2.5 | 16 | 19 | 0.2 |
| M27X2 | 16 | 27 | 0, +0.2 | 33 | 2.5 | 16 | 20 | 0.2 |
| M33X2 | 23 | 33 | 0, +0.3 | 41 | 2.5 | 18 | 22 | 0.2 |
| M42X2 | 30 | 42 | 0, +0.3 | 51 | 2.5 | 20 | 24 | 0.2 |
| M48X2 | 36 | 48 | 0, +0.3 | 56 | 2.5 | 22 | 36 | 0.2 |

N

2 ISO 6149-1公制螺纹油口及相配柱端 ISO 6149-1 metric thread port and mating stud end

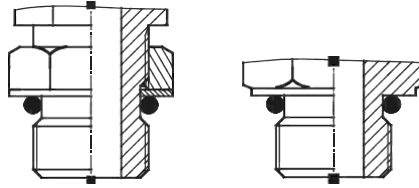

ISO 6149-2、ISO 6149-3柱端
ISO 6149-2、ISO 6149-3 stud end

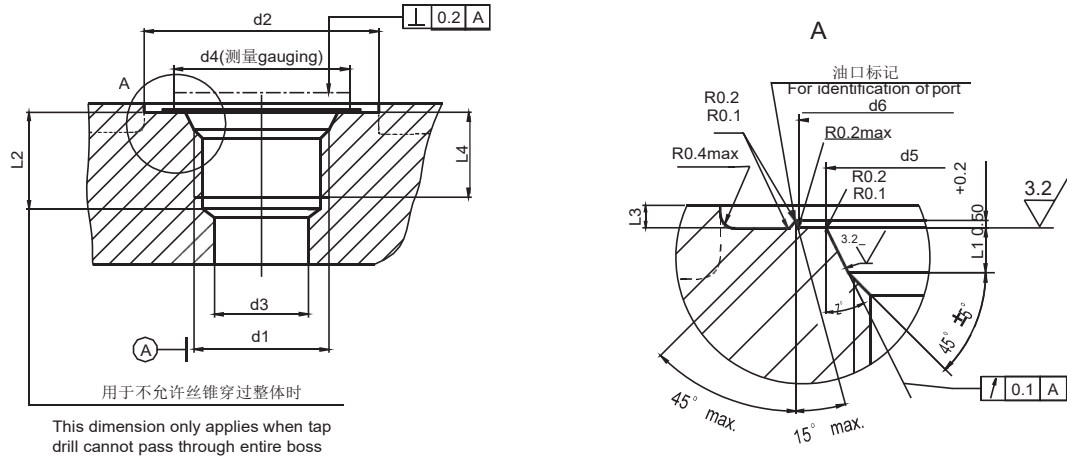

ISO 6149-1油口 ISO 6149-1 Port

油口尺寸 Port Dimensions mm

| 螺纹 Thread d1 | d2 | | d3 参考 ref. | d4 | d5 +0.1 0 | d6 +0.5 0 | L1 +0.4 0 | L2 min. | L3 max. | L4 min. | Z° ±1° | O形圈 O-RING |
|--------------------|---------|--------|------------------|------|-----------------|-----------------|-----------------|------------|------------|------------|-----------|---------------|
| | min. 1) | min 2) | | | | | | | | | | |
| M8X1 | 17 | 14 | 3 | 12.5 | 9.1 | 14 | 1.6 | 11.5 | 1 | 10 | 12 | 6.1X1.6 |
| M10X1 | 20 | 16 | 4.5 | 14.5 | 11.1 | 16 | 1.6 | 11.5 | 1 | 10 | 12 | 8.1X1.6 |
| M12X1.5 | 23 | 19 | 6 | 17.5 | 13.8 | 19 | 2.4 | 14 | 1.5 | 11.5 | 15 | 9.3X2.2 |
| M14X1.5 | 25 | 21 | 7.5 | 19.5 | 15.8 | 21 | 2.4 | 14 | 1.5 | 11.5 | 15 | 11.3X2.2 |
| M16X1.5 | 28 | 24 | 9 | 22.5 | 17.8 | 24 | 2.4 | 15.5 | 1.5 | 13 | 15 | 13.3X2.2 |
| M18X1.5 | 30 | 26 | 11 | 24.5 | 19.8 | 26 | 2.4 | 17 | 2 | 14.5 | 15 | 15.3X2.2 |
| M20X1.5 | 32 | 27 | -- | 25.5 | 21.8 | 27 | 2.4 | -- | 2 | 14.5 | 15 | 17.3X2.2 |
| M22X1.5 | 34 | 29 | 14 | 27.5 | 23.8 | 29 | 2.4 | 18 | 2 | 15.5 | 15 | 19.3X2.2 |
| M27X2 | 40 | 34 | 18 | 32.5 | 29.4 | 34 | 3.1 | 22 | 2 | 19 | 15 | 23.6X2.9 |
| M33X2 | 49 | 43 | 23 | 41.5 | 35.4 | 43 | 3.1 | 22 | 2.5 | 19 | 15 | 29.6X2.9 |
| M42X2 | 60 | 52 | 30 | 50.5 | 44.4 | 52 | 3.1 | 22.5 | 2.5 | 19.5 | 15 | 38.6X2.9 |
| M48X2 | 66 | 57 | 36 | 55.5 | 50.4 | 57 | 3.1 | 25 | 2.5 | 22 | 15 | 44.6X2.9 |
| M60X2 | 76 | 67 | 44 | 65.5 | 62.4 | 67 | 3.1 | 27.5 | 2.5 | 24.5 | 15 | 56.6X2.9 |

3 DIN 3852英管螺纹油口及相配柱端 DIN 3852 BSP thread port and mating stud end

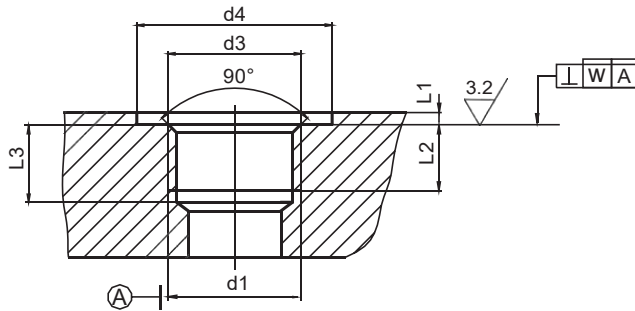
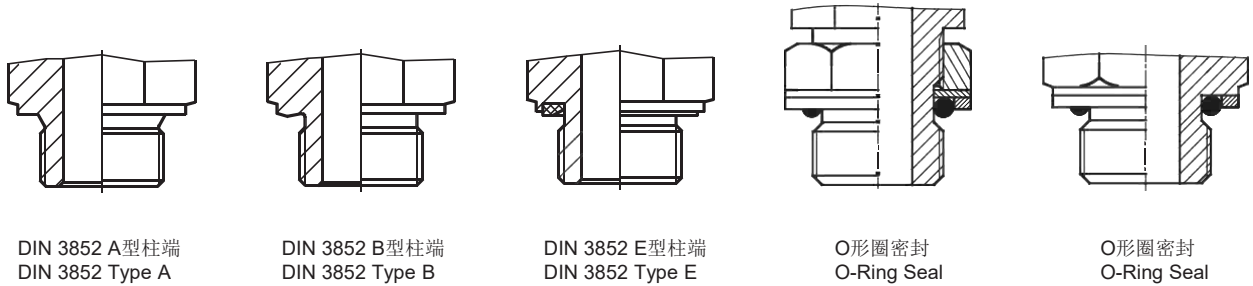

DIN 3852油口 DIN 3852 Port

油口尺寸 Port Dimensions mm

| 螺纹 Thread d1 | d3 | | d4 +0.4 0 | | L1 max. | L2 min. | L3 min. | w |
|--------------------|------|--------|--------------------|--------------|------------|------------|------------|-----|
| | | | B、E型柱端 Type B,E | 其它 Others | | | | |
| G1/8X28 | 9.8 | 0,+0.2 | 15 | 19 | 1 | 8 | 13 | 0.1 |
| G1/4X19 | 13.2 | 0,+0.2 | 19 | 25 | 1.5 | 12 | 18.5 | 0.1 |
| G3/8X19 | 16.7 | 0,+0.2 | 23 | 28 | 2 | 12 | 18.5 | 0.1 |
| G1/2X14 | 21 | 0,+0.2 | 27 | 34 | 2.5 | 14 | 22 | 0.1 |
| G3/4X14 | 26.5 | 0,+0.2 | 33 | 42 | 2.5 | 16 | 24 | 0.2 |
| G1X11 | 33.3 | 0,+0.3 | 40 | 47 | 2.5 | 18 | 27 | 0.2 |
| G1.1/4X11 | 42 | 0,+0.3 | 50 | 58 | 2.5 | 20 | 29 | 0.2 |
| G1.1/2X11 | 47.9 | 0,+0.3 | 56 | 65 | 2.5 | 22 | 31 | 0.2 |
| G2X11 | 59.7 | 0,+0.3 | 69 | 76 | 3 | 24 | 33 | 0.2 |

4 BS 5380英管螺纹油口及相配柱端 BS 5380 BSP thread port and mating stud end

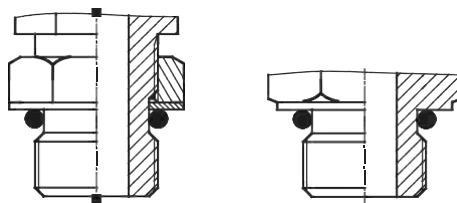

BS 5380柱端 BS 5380 stud end

N

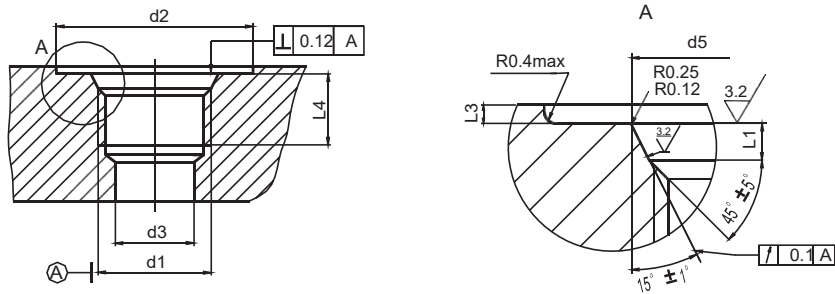

BS 5380油口 BS 5380 Port

油口尺寸 Port Dimensions mm

| 螺纹 Thread d1 | d2 min. | d3 max. | d5 +0.12 0 | L1 +0.4 0 | L3 max. | L4 min. | O形圈 O-RING |
|--------------------|------------|------------|------------------|-----------------|------------|------------|---------------|
| G1/8X28 | 15 | 14 | 11.24 | 1.3 | 0.6 | 10.5 | 8.1X1.6 |
| G1/4X19 | 19 | 18 | 14.16 | 1.2 | 0.6 | 11.0 | 10.1X1.6 |
| G3/8X19 | 23 | 22 | 18.86 | 1.9 | 0.6 | 12.5 | 13.6X2.4 |
| G1/2X14 | 27 | 26 | 22.40 | 1.9 | 0.8 | 15.0 | 17.6X2.4 |
| G5/8X14 | 31 | 30 | 26.00 | 2.4 | 0.8 | 16.3 | 19.5X3.0 |
| G3/4X14 | 33 | 32 | 28.92 | 2.4 | 1.1 | 16.3 | 22.5X3.0 |
| G1X11 | 40 | 39 | 35.50 | 2.4 | 1.1 | 19.1 | 29.5X3.0 |
| G1.1/4X11 | 50 | 49 | 43.56 | 2.4 | 1.1 | 21.4 | 36.5X3.0 |
| G1.1/2X11 | 56 | 55 | 49.42 | 2.4 | 1.1 | 22.5 | 42.5X3.0 |
| G2X11 | 69 | 68 | 61.42 | 2.4 | 1.1 | 25.7 | 54.5X3.0 |

5 JIS B 2351英管螺纹油口及相配柱端 JIS B 2351 BSP thread port and mating stud end

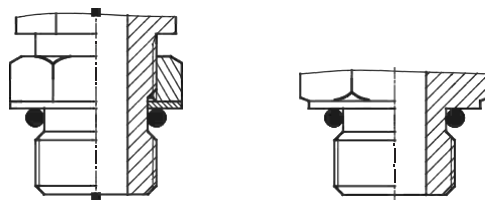

JIS B 2351 柱端 JIS B 2351 stud end

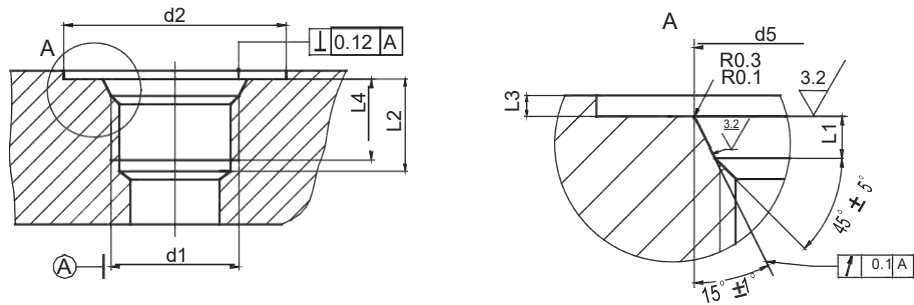

JIS B 2351 油口 JIS B 2351 Port

油口尺寸 Port Dimensions mm

| 螺纹 Thread d1 | d2 ± 0.3 | d5 + 0.1 0 | L1 + 0.4 0 | L2 min. | L3 max. | L4 min. | O形圈 O-RING |
|--------------------|-------------|------------------|------------------|------------|------------|------------|---------------|
| G1/8X28 | 18 | 11.6 | 2 | 15 | 1 | 10 | 7.8X1.9 |
| G1/4X19 | 24 | 15.6 | 2.5 | 18 | 1.5 | 12 | 10.8X2.4 |
| G3/8X19 | 28 | 18.6 | 2.5 | 18 | 2 | 12 | 13.8X2.4 |
| G1/2X14 | 34 | 22.6 | 2.5 | 24 | 2.5 | 16 | 17.8X2.4 |
| G3/4X14 | 45 | 29.8 | 3.5 | 25 | 2.5 | 17 | 22.1X3.5 |
| G1X11 | 51 | 35.8 | 3.5 | 30 | 2.5 | 21 | 28.7X3.5 |
| G1.1/4X11 | 62 | 44.8 | 3.5 | 30 | 2.5 | 21.4 | 37.7X3.5 |
| G1.1/2X11 | 68 | 50.8 | 3.5 | 30 | 2.5 | 21.4 | 43.7X3.5 |

6 ISO 11926-1美制螺纹油口及相配柱端 ISO 11926-1 SAE thread port and mating stud end

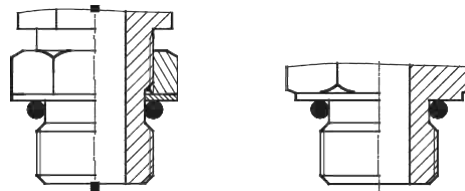

ISO 11926-2、ISO 11926-3美制螺纹柱端

ISO 11926-2、ISO 11926-3 SAE thread stud end

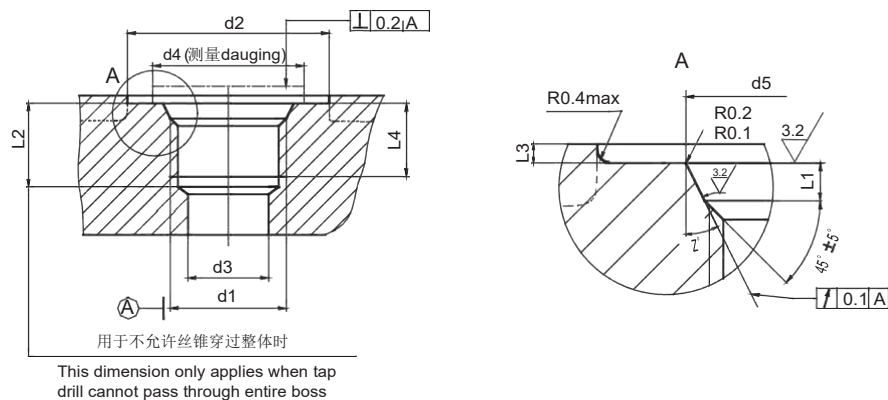

ISO 11926-1美制螺纹油口
ISO 11926-1 SAE thread port

油口尺寸 Port Dimensions mm

| 螺纹 Thread d1 | d2 min. | d3 参 考 ref. | d4 min. | d5 ±0.05 | L1 +0.4 0 | L2 min. | L3 max. | L4 min. | Z° ±1° | O形圈 O-RING |
|--------------------|------------|----------------------|------------|-------------|-----------------|------------|------------|------------|-----------|---------------|
| 5/16"X24 | 17 | 2.5 | 11 | 9.15 | 1.9 | 12 | 1.6 | 10 | 12 | 6.07X1.63 |
| 3/8"X24 | 19 | 3.5 | 13 | 10.75 | 2.4 | 12 | 1.6 | 10 | 12 | 7.65X1.63 |
| 7/16"X20 | 21 | 4.5 | 15 | 12.45 | 2.4 | 14 | 1.6 | 11.5 | 12 | 8.92X1.83 |
| 1/2"X20 | 23 | 6 | 16 | 14.05 | 2.5 | 14 | 1.6 | 11.5 | 12 | 10.52X1.83 |
| 9/16"X18 | 25 | 7.5 | 18 | 15.70 | 2.5 | 15.5 | 2.4 | 12.7 | 15 | 11.89X1.98 |
| 3/4"X16 | 30 | 10 | 22 | 20.65 | 2.5 | 17.5 | 2.4 | 14.3 | 15 | 16.36X2.21 |
| 7/8"X14 | 34 | 12.5 | 26 | 24 | 3.3 | 20 | 2.4 | 16.7 | 15 | 19.18X2.46 |
| 1.1/16"X12 | 41 | 16 | 32 | 29.2 | 3.3 | 23 | 2.4 | 19 | 15 | 23.47X2.95 |
| 1.3/16"X12 | 45 | 18 | 35 | 32.4 | 3.3 | 23 | 2.4 | 19 | 15 | 26.62X2.95 |
| 1.5/16"X12 | 49 | 21 | 38 | 35.55 | 3.3 | 23 | 3.2 | 19 | 15 | 29.74X2.95 |
| 1.5/8"X12 | 58 | 27 | 48 | 43.55 | 3.3 | 23 | 3.2 | 19 | 15 | 37.46X3.00 |
| 1.7/8"X12 | 65 | 33 | 54 | 49.9 | 3.3 | 23 | 3.2 | 19 | 15 | 43.69X3.00 |
| 2.1/2"X12 | 88 | 45 | 70 | 65.75 | 3.3 | 23 | 3.2 | 19 | 15 | 59.36X3.00 |

7 锥管螺纹油口 Taper Thread Port

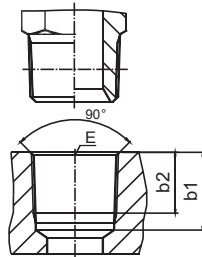

锥管螺纹油口 Taper Thread Port

油口尺寸 Port Dimensions mm

| 螺纹 Thread E | | b1 min. | b2 min. |
|----------------------|-------------|---------|---------|
| 英锥管螺纹 BSPT Thread | R1/8x28 | 9.5 | 7.5 |
| | R1/4x19 | 13.5 | 11 |
| | R3/8x19 | 14 | 11.5 |
| | R1/2x14 | 17.5 | 15 |
| | R3/4x14 | 19 | 16.5 |
| | R1x11 | 22.5 | 19.5 |
| | R1.1/4x11 | 24.8 | 21.5 |
| | R1.1/2x11 | 24.8 | 21.5 |
| | R2x11 | 29.5 | 26 |
| 布锥管螺纹 NPT Thread | Z1/8x27 | 10 | 7.8 |
| | Z1/4x18 | 14 | 11.8 |
| | Z3/8x18 | 14 | 11.8 |
| | Z1/2x14 | 18 | 15.5 |
| | Z3/4x14 | 18.5 | 16 |
| | Z1x11.5 | 22.5 | 19.5 |
| | Z1.1/4x11.5 | 24 | 20.5 |
| | Z1.1/2x11.5 | 24 | 20.5 |
| | Z2x11.5 | 25 | 21.5 |

接头概述及装配说明 Fittings And Fittings Assembly Instructions

O形圈平面密封接头 O-RING FACE SEAL FITTINGS

O形圈平面密封接头概述 O-RING FACE SEAL FITTINGS INSTRUCTIONS

- O形圈平面密封的基本结构可以有两种，第一种为：由接头体、O形圈、螺母、接管组成，接管与系统管路中的钢管焊接连接，如图1所示。第二种为：由接头体、O形圈、螺母、衬套组成，管子被翻边成90°，如图2所示。使用图1所示的基本结构时，须保证焊接的质量。

The fitting has two types. The first type consists of a body, an O-ring, a nut and the weld tube. The weld tube is brazed with the system steel tube, see Fig.1. The second type consists of a body, an O-ring, a nut and a sleeve. As shown in Fig.2, the tube is flanged to 90°. When used as Fig.1, the quality of weld is very important.



图1 Fig.1



图2 Fig.2

- O形圈平面密封能很好的适用于高压系统，如使用硬度为N90的O形圈，能有更好的密封作用，更有效的防止泄漏。由于使用O形圈密封，因此使用的温度范围受O形圈材质的影响。
O-ring face seal fittings are suit for high pressure system. If the hardness of O-ring is N90, the sealing will better, and be good for preveting leakage.

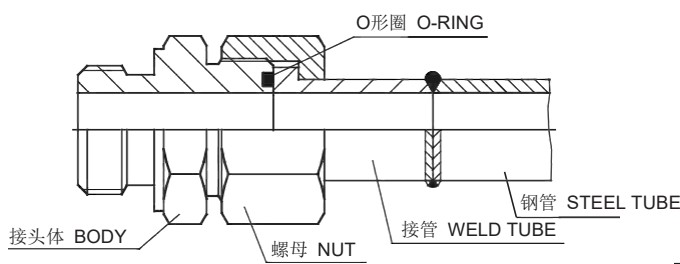
- O形圈平面密封接头的连接螺纹有两种：公制螺纹，美制ORFS螺纹。
The O-ring face seal fitting has two connected thread:metric thread and ORFS thread.

- O形圈密封槽的结构有三种，见图3、4、5。其中3结构能保持O形圈在安装时或垂直倒置时不掉下，方便安装；负压时O形圈不会被吸入油路。4结构则不具备3结构的前一优点。5结构既不具备3结构的前一优点，而且负压时会被吸入油路。

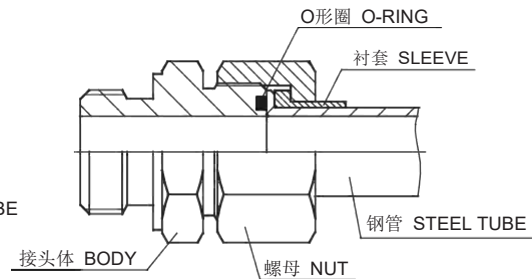
As shown in Fig.3, Fig.4 and Fig.5, the O-ring seal groove has three types. The advantage of type Fig.3. It is very convenience for installation, when put the groove adown O-ring could be held in the groove and not drop; The O-ring could not enter the hydraulic system when the pressure is negative. The type Fig.4 has only the later adavantage of the type Fig.3. The type Fig.5 has no above adavantage.



图3
Fig.3



图4
Fig.4

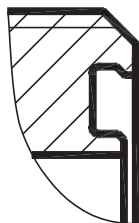

图5
Fig.5

- 对公制螺纹的O形圈槽如需按JB标准生产时，为图5的结构。本公司建议选用图3结构，用户可在订货时用文字说明。对美制ORFS螺纹的O形圈槽，本公司全部采用图3结构生产，不生产图4或图5结构。

For metric thread O-ring groove JB standard is type Fig.5, but we suggest that the type Fig.3 should be chosen and make a annotation when order. For ORFS O-ring groove, we produce as type Fig.3 only.

O形圈平面密封接头安装 O-RING FACE SEAL FITTINGS ASSEMBLY INSTRUCTIONS

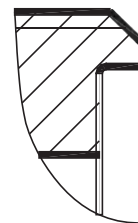
● 安装 Assembly

- 1 对图1的基本结构，在安装前应先垂直锯下钢管（±1°以内），去掉内外径毛刺，并去油及氧化物，套上螺母后再焊接。对图2的基本结构，在垂直锯下后用专用设备将管端翻边成90°，且尺寸D应在D1和D2之间，见图6。
As shown in Fig.1, the tube end is cut squarely (within +/- 1°) before assembled, deburr the O.D. and I.D. of the tube, remove all oil and oxide, weld after put the nut. As shown in Fig.2, the tube is flanged to 90° with special equipment after cut, diameter D should fall between diameter D1 and D2, see Fig.6.



图6 Fig.6

- 2 如果接头体未放置O形圈，则应先放好O形圈。 The fitting body should be installed O-ring firstly.
- 3 按图1或图2，将接管或钢管翻边压住接头体O形圈，用手拧紧螺母，再用扭矩扳手按扭矩建议表扳紧；如无扭矩扳手，可用普通扳手再拧紧1/4到1/2圈。
As shown in Fig.1 or Fig.2, place tube assembly against the fitting body so that the flat face of the weld tube (or flanged steel tube) comes in full contact with the O-ring. Tighten the nut onto the fitting body by hand, then tighten it to the recommended torque with a torque wrench. If torque wrenches are not available, tighten it 1/4 to 1/2 turn with general wrench.

● 重复安装 Reassembly

由于是平面密封型式且与安装力垂直，在安装过程中O形圈可能会扭曲，因此每次重复安装时，应检查O形圈有无损坏，必要时需更换。

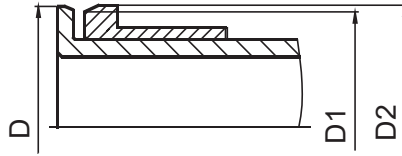
Because the sealing surfaces are flat and perpendicular to the installation force, the O-ring may be distorted during assembly. The O-ring should be inspected at each disassembly and replaced when necessary.

● 泄漏原因 Leakage reason

- 1 O形圈未正确的安放在O形圈槽内。 The O-ring is installed in the face seal groove improperly.
- 2 O形圈有损伤或损坏。 The O-ring is damaged.
- 3 接头密封面、接管或翻边有凹坑或其他影响密封的缺陷。 The sealing surface, the weld tube or the flange are not flat, or have another fault affecting sealing.
- 4 翻边过大或过小，不能压住O形圈。 The flange is too large or too small that the O-ring can't be compressed.
- 5 O形圈材质不适用于工作温度。 The O-ring material is not suit for working temperature.
- 6 O形圈硬度不够。 The O-ring hardness is not enough.
- 7 连接螺母松开。 The connected nut is loosen.

卡套接头 BITE TYPE TUBE FITTINGS

卡套接头概述 BITE TYPE TUBE FITTINGS INSTRUCTIONS

卡套式管接头由三部分组成：接头体、卡套、螺母。当卡套和螺母套在钢管上插入接头体后，旋紧螺母时，卡套前端外侧与接头体锥面贴合，内刃均匀地咬入无缝钢管，形成有效密封。见图7。

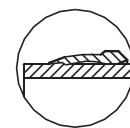
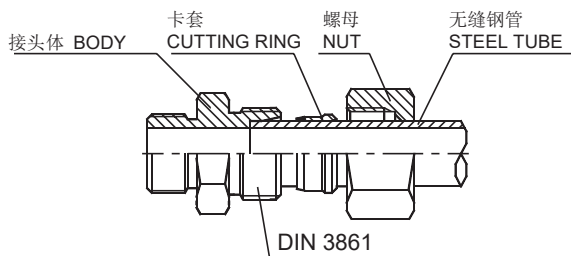

卡套装在管子上
Cutting ring bite the tube

图7 Fig.7

附加资料 Information

24° 锥的W型柱端按DIN 3861标准。卡套采用双刃卡套。

通常情况接头体和螺母表面镀锌处理。接头适用的工作压力最高可达63MPa，无缝钢管外径最大为42mm。

Bite type fitting consists of three parts: body, cutting ring and nut. When tightening nut, cutting ring is driven forward on the tube then bites the tube with the edge of cutting ring, this is how sealing is achieved and results in internal ridge inside the tube. See Fig-7.

The tube connection side of fitting is manufactured in accordance with standard: DIN 3861. In general, body and nuts' surface is plated zinc. Bite type fitting can be used in system with Max 63MPa. The connection tube OD is Max 42mm.

卡套接头的装配 BITE TYPE TUBE FITTINGS ASSEMBLY INSTRUCTIONS

● 安装 Assembly

- 1 锯下合适长度的无缝钢管，去除端口处毛刺。管子端面要与轴线垂直，角度公差不得大于0.5°。如果管子需要折弯，则从管子端面至弯曲部位的直线段长度不能少于三倍螺母长度。

Cut the tube at right angle and de-burr inside and outside of tube end. Minimum straight length of tube from the starting point of tube bend to the tube end may be 3 times height of the nut.

- 2 把螺母和卡套套在无缝钢管上。注意螺母和卡套的方向，不要装反了。

Set a nut and cutting ring on the tube. Make sure the cutting ring and the nut are facing the fitting.

- 3 在预装配接头体螺纹和卡套上涂上润滑油，把管子插入接头体，（管子一定要插到底）用手旋紧螺母。

Lubricate the pre-assembly fitting body threads and cutting ring. Insert tube end into fitting body until it is firmly seated on bottom (fitting shoulder) and hand-tighten the nut.

- 4 拧紧螺母直至卡套卡住管子，这个转折点可以通过拧紧力矩的增加感觉到(压力点)。

Tighten nut until ferrule grips tube which is felt by a noticeable increase in torque (increase in force).

- 5 达到压力点后，再将压紧螺母拧紧1/2圈。 Tighten nut 1/2 of a turn after increase in force.

- 6 将预装配接头体拆下，检查卡套刃边的嵌入情况，可见的突起带必须填满卡套端面的空间。卡套可以稍旋转，但不能轴向推移。

Disassembly the pre-assembly fitting body .Check penetration of cutting edge.A visible ring of material should fill the space in front of the profile ring end face. Profile ring may turn on tube, but should not be capable of axial displacement.

- 7 最终安装，将实际安装中的接头体的螺纹涂上润滑油、压紧螺母与之配合拧至可感觉到的拧紧力增加为止。接着再拧紧1/2圈安装完毕。

Lubricate the fitting body to be subsequently installed. Tighten nut until a noticeable increase in force is required. Tighten nut by 1/2 of a turn beyond this point for final assembly.

● 重复安装 Reassembly

所有的卡套接头都可以多次重装，但要保证零件无损坏且清洁。

Fitting can be used many times. To ensure this, parts must be clean and free of defects.

- 1 把管子插入接头体直至卡套贴紧接头体内锥面，用手拧紧螺母。

Insert the tube into fitting body until cutting ring seats firmly in the fitting and hand-tighten the nut.

- 2 用扳手拧紧螺母，直至拧紧力矩急剧增大，再拧紧1/4至1/2圈即可。

Tighten the nut with a wrench by holding the fitting body with a backup wrench until a sharp rise in torque is felt. Further tighten the nut 1/4 to 1/2 turn.

● 检查 Checking up the bite condition

可拆下管子检查装配是否合乎要求：卡套端部的管子上应该有均匀的轻微凸起。卡套不能前后滑动，但允许有轻微转动。

All bite type fitting must be disassembled prior to service to check up if small ridge inside the tube is completely formed around front edge of cutting ring. Otherwise tighten slightly more to have it. Cutting ring may rotate on the tube that doesn't mean wrong installation. The cutting ring shall be refitted once the nut is retightened.

● 泄漏原因 Leakage reason

- 1 管子没插到底。 When the tube is not fully bottomed.
- 2 螺母没有拧紧。 When the nut is not tightened enough.
- 3 管子外表刮伤或管子不圆。 When the tube is of scratches or oval.
- 4 管子太硬。 When the tube is extremely hard.

扩口式接头 FLARED TUBE FITTINGS

扩口式接头概述 FLARED TUBE FITTINGS INSTRUCTIONS

- 扩口式管接头采用图8的结构型式，由三部分组成：接头体、衬套、螺母。钢管端口扩口角为37°。使用时钢管的37°扩口角紧压在接头体的锥面上，形成金属密封。使用衬套能吸收并减少管路振动和管子疲劳，并且拧紧螺母时，钢管不会跟着转动。

As shown in Fig.8, the fitting consists of three pieces: the body, sleeve and nut. The tube end is flared at a 37° angle and held between the fitting nose and the sleeve with the nut, providing a metal to metal seal between the fitting nose and the tube flare. The advantage of sleeve is reducing vibration and fatigue of tube, the steel tube will not turn when tighten the nut.



图 8 Fig.8

- 扩口式管接头的连接螺纹有两种：公制螺纹，美制JIC螺纹。
The flared tube fitting has two connected thread: metric thread and JIC thread.
- 扩口式管接头安装方便，不用焊接，广泛用于中低压管路系统。由于是金属对金属的硬密封，因此适用温度范围大。It is easy to assemble without weld. It is especially suited for low and medium pressure systems. As metal to metal seal, it allows wide operating temperature range.

扩口式接头安装 FLARED TUBE FITTINGS ASSEMBLY INSTRUCTIONS

● 安装 Assembly

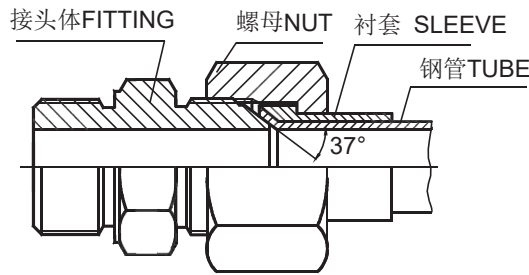
- 1 在安装前应先垂直锯下钢管（±1°以内），去掉内外径毛刺，清除脏物，需要时套上衬套、螺母后在专用设备上扩口。且尺寸D应在D1和D2之间，见图9。

Cut tube reasonably square (within +/- 1°), deburr the I.D. and O.D. of the tube, remove the dirt. Set a nut and sleeve on the tube, the tube is flared with special equipment, diameter D should fall between diameter D1 and D2, see Fig.9.



图 9 Fig.9

- 2 扩口式管接头半数以上的泄漏是由于扩口或安装不当引起的。安装时应使钢管、扩口轴线与接头体锥面轴线同心。
Over half of the leakage with flared fittings is caused by improper flaring or installation. When assembled, the axis of the tube, the tube flare and the fitting nose should be concentric.
 - 3 将管子扩口面与接头体锥面对准贴紧后，用手拧紧螺母，再用扭矩扳手按扭矩建议表扳紧；如无扭矩扳手，可用普通扳手再拧紧1到2圈，一般大规格1圈，小规格2圈。
Screw the nut onto the fitting body by hand and tighten it to the recommended torque with a torque wrench. If torque wrenches are not available, tighten 1 to 2 turns with general wrench. In general, the small fitting is tighten about 1 turn and the large fitting is tighten about 2 turns.
- 重复安装 Reassembly
所有的扩口式接头都可以多次重装，但要保证零件无损坏且清洁。注意扩口无开裂。
Fitting can be used many times. To ensure this, parts must be clean and free of defects. no tube cracked.

- **泄漏原因 Leakage reason**
 - 1 安装时未对准，钢管、扩口轴线与接头体锥面轴线不同心，强制将管子扳到位。
When assembled, the axis of the tube, the tube flare and the fitting nose are not concentric, force the tube to the station.
 - 2 拧紧力矩过大或过小。 The tighten force is too large or too small.
 - 3 管子扩口处开裂。 The tube flare is cracked.
 - 4 接头体或管子扩口处的密封面上有影响密封的杂质、凹坑等。 The fitting body or the tube flare is collapsed.
 - 5 连接螺母松开。 The connected nut is loosen.
 - 6 过大的扭矩或多次重复使用造成接头结合密封面损坏，丧失密封能力。
The sealing surface is damaged for longer torque or reassembly time after time.
 - 7 管子扩口太大或太小，不能与接头体很好的贴合密封。
The tube flare is too large or too small, so the seal between the fitting nose and the tube flare is not effective.

锥管螺纹接头 TAPER THREAD FITTINGS

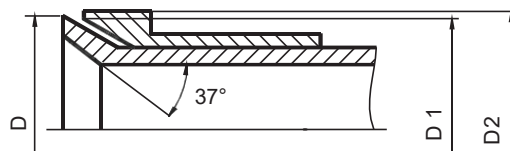
锥管螺纹接头概述 TAPER THREAD FITTINGS INSTRUCTIONS

- 锥管螺纹接头的连接螺纹有三种：美制NPT即60°密封锥管螺纹（GB/T 12716、ANSI/ASME B1.20.1）；美制NPTF干密封锥管螺纹（ANSI B1.20.4）；英制BSPT即55°密封锥管螺纹（GB/T 7306）。
The connected thread has three types: NPT, NPTF and BSPT.
- NPT、BSPT螺纹连接时，必须使用密封料，NPTF可以形成金属对金属的密封，但使用时也常常用密封料。密封料可以有多种，如：生料带、密封胶、厌氧胶、防振密封胶等。
NPT、BSPT threads should be assembled with sealant. NPTF is metal to metal seal, but use sealant also. Sealants are available in various forms such as teflon tape, paste and anaerobic glue etc..
- 由于安装时使用了密封带、胶等，如果安装不当，会对油液造成污染，甚至堵塞油路。
Teflon tape, paste etc., if applied improperly, they will pollute the oil of the hydraulic system, even jam the system.
- 小规格螺纹比大规格的密封效果要好，一般3/4"以下密封可靠性好。
The seal of the small thread is better than the large. In general the seal of less than 3/4" are good.
- 直通接头用锥螺纹时，连接会比较紧凑，但用于三通或角弯等异型接头时，则较难控制方向，因此建议选用ISO 6149、ISO 11926等可调向接头。
The connect will compact when the taper thread for straight fitting, if for elbow or tee or cross fittings, the assemble angle is difficult to control, so suggest that the adjustable stud end fittings should be used, for example ISO 6149, ISO 11926 etc..

锥管螺纹接头安装 TAPPER THREAD FITTINGS ASSEMBLY INSTRUCTIONS

- **安装 Assembly**
 - 1 检查油口及连接螺纹，保证无脏物、毛刺及其他异物。
Inspect port and connectors to ensure that threads on both are free of dirt, burrs and excessive nicks.
 - 2 在外螺纹上加密封料。但在第1、2牙螺纹上不要覆盖密封料，以免污染系统油液。加生料带时应按顺时针方向（从管端看）在外螺纹上缠绕1.5圈到2圈。
Apply sealant to male pipe threads. With any sealant, the first and second threads should be uncovered to avoid system contamination. If Teflon tape is used it should be wrapped 1.1/2 to 2 turns in clockwise direction when viewed from the pipe thread end.
 - 3 用手拧紧，再用扳手扳紧1.5到3圈，一般小规格扳紧2.5圈左右，大规格扳紧2圈左右。
First tighten the fitting with hand, then tighten with a wrench 1.1/2 to 3 turns. In general, the small fitting is tighten about 2.5 turns and the large fitting is tighten about 2 turns.
- **重复安装 Reassembly**

锥管螺纹接头可以重复安装，重复安装时应检查密封料是否已损耗，需要时将接头清理干净后重新加密封料安装。
The taper thread fitting can be reassembled. When reassembled, check if sealant has worn thin.
- **泄漏原因 Leakage reason**
 - 1 没有使用密封料或密封料已损耗。 There is no sealant used or sealant has worn thin.
 - 2 螺纹已磨损。 Threads are galled.
 - 3 螺纹制造不正确，接头螺纹已进入油口很深但仍未旋紧。 Fitting screws in too far into the port.
 - 4 螺纹有严重缺口或刻痕。 Threads are severely nicked.
 - 5 因振动导致螺纹松动。 Threads are loosen.

硬管管路的正确布置 Routing of Tube Lines

安装布置硬管管路时，应注意下列几点： Routing of tube lines should pay attention to the following:

- 管子长度要短，管径要合适，流速过高会损失能量。
The length of tube should be short and tube O.D. should be suitable, the energy will loss if the velocity is too large.
- 两固定点之间的连接，应避免紧拉，需有一个松弯部分，如图1所示，以便于装卸，也不会因热胀冷缩而造成严重的拉应力。
The tube connection should avoid strain, it is good that have a bending part. See Fig.1.



图1 Fig.1

- 管子的弯管半径应尽可能大，其最小弯管半径约为硬管外径的2.5倍。管端处应留出直管部分，其距离为管接头螺母高度的二倍以上。如图2所示。

The tube bending radius is large as possible. The min. bending radius is about 2.5 times of the O.D.. The tube end should be straight and the spacing is above 2 times of the tube nut. See Fig.2:

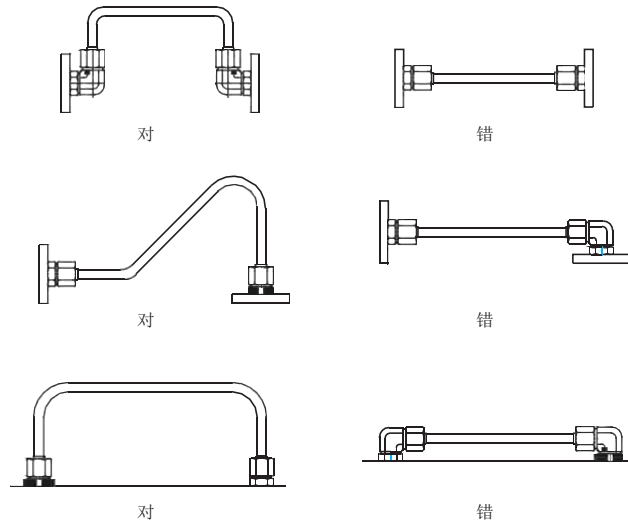

图2 Fig.2

- 硬管的主要失效型式为机械振动引起的疲劳失效，因此当管路较长时，需加管夹支撑，不仅可以缓冲振动，还可减少噪音。在有弯管的管路中，在弯管的二端直管段处要加支撑管夹固定，在与软管连接时，应在硬管端加管夹支撑。管夹间距推荐如图3及表1。

Fatigue failure due to mechanical vibration accounts for the majority of tube line failures. When the tube line is longer, we can use tube clamps to support the system. Proper clamping of the tube can reduce system noise. Recommended tube clamp spacing as shown in Fig.3 and table 1:

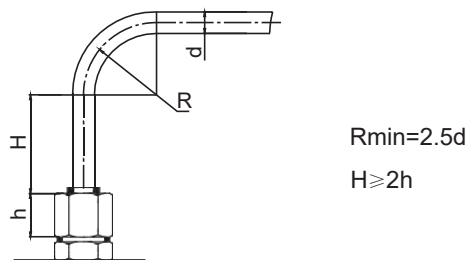

图3 Fig.3

表 1

| 管子外径 TUBE O.D. (mm) | 管夹间距 A CLAMP SPACING A (mm) | 管夹间距 B CLAMP SPACING B (mm) | 管夹间距 C CLAMP SPACING C C(mm) |
|---------------------------|-----------------------------------|-----------------------------------|------------------------------------|
| 6-12.7 | 50 | 900 | 100 |
| 15.9-22.2 | 100 | 1200 | 200 |
| 25.4 | 100 | 1500 | 200 |
| 31.8-38.1 | 150 | 2100 | 300 |
| 48.3 | 150 | 2700 | 300 |

- 避开障碍物时不要使用太多的90°弯曲管，流体经过一个90°的弯曲管的压降比经过两个45°的弯曲管还大。如图4 应选用正确的弯管角度。

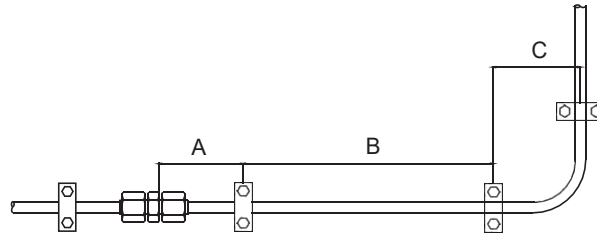
Get around obstructions without using excessive amount of 90° bends. Pressure drop due to one 90° bend is greater than that due to two 45° bends. See Fig.4 :



图4 Fig.4

- 布置管路时，尽量使管路远离需经常维修的部件。如图5所示。
Keep tube lines away from components that require regular maintenance.

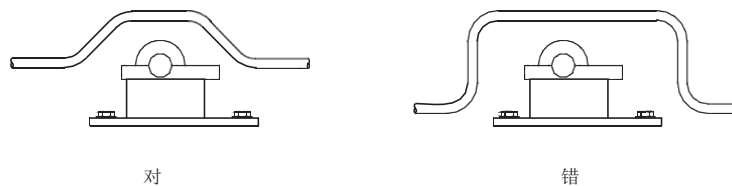

图5 Fig.5

- 管路排列应有顺序、整齐，便于查找故障、保养和维修。如图6所示。
Have a neat appearance and allow for easy trouble-shooting, maintenance and repair. See Fig.6 :

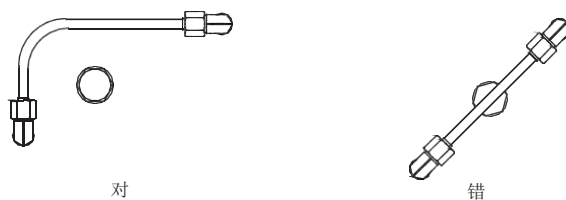

图6 Fig.6

螺纹扭矩建议表 Recommended Thread Torque

公制螺纹 Metric Thread

| 螺 纹 THREAD | 螺母扭矩 N.M NUT TORQUE |
|------------|------------------------|
| M12x1.5 | 10-20 |
| M14x1.5 | 20-35 |
| M16x1.5 | 25-40 |
| M18x1.5 | 30-45 |
| M20x1.5 | 35-50 |
| M22x1.5 | 40-70 |
| M24x1.5 | 40-70 |
| M26x1.5 | 60-100 |
| M30x2.0 | 80-120 |
| M36x2.0 | 100-150 |
| M42x2.0 | 150-220 |
| M45x2.0 | 180-250 |
| M52X2.0 | 200-300 |

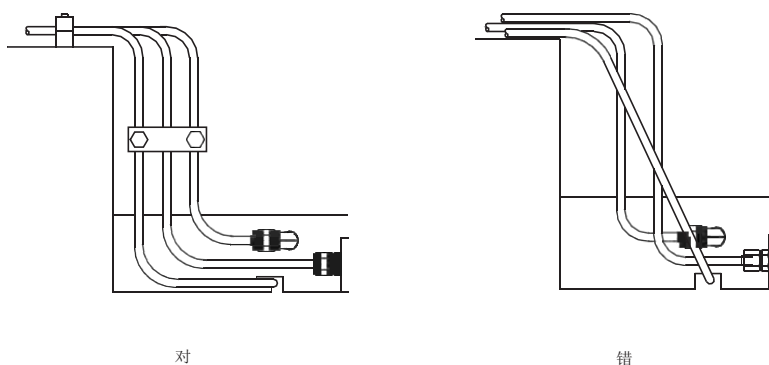
英管螺纹 BSP Thread

| 螺 纹 THREAD | 螺母扭矩 N.M NUT TORQUE |
|------------|------------------------|
| G1/8"x28 | 11-12 |
| G1/4"x19 | 25-28 |
| G3/8"x19 | 41-48 |
| G1/2"x14 | 72-82 |
| G5/8"X14 | 96-110 |
| G3/4"X14 | 124-137 |
| G1"x11 | 151-165 |
| G1.1/4"x11 | 192-206 |
| G1.1/2"x11 | 261-275 |
| G2"x11 | 343-357 |

美制 JIC 螺纹 JIC Thread

| 螺 纹 THREAD | 螺母扭矩 N.M NUT TORQUE |
|------------|------------------------|
| 7/16"x20 | 15-16 |
| 1/2"x20 | 19-21 |
| 9/16"x18 | 24-28 |
| 3/4"x16 | 49-53 |
| 7/8"x14 | 77-85 |
| 1.1/16"x12 | 107-119 |
| 1.3/16"x12 | 127-140 |
| 1.5/16"x12 | 147-154 |
| 1.5/8"x12 | 172-181 |
| 1.7/8"x12 | 215-226 |
| 2.1/2"x12 | 332-350 |

美制 ORFS 螺纹 ORFS Thread

| 螺 纹 THREAD | 螺母扭矩 N.M NUT TORQUE |
|-------------|------------------------|
| 9/16"x18 | 14-16 |
| 11/16"x16 | 24-27 |
| 13/16"x16 | 43-47 |
| 1"x14 | 60-68 |
| 1.3/16"x12 | 90-95 |
| 1.7/16"x12 | 125-135 |
| 1.11/16"x12 | 170-190 |
| 2"x12 | 200-225 |

密封件 Seal

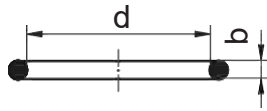

O形圈 O-Ring

DIN 24°锥轻系列O形圈密封用O形圈
For DIN 24° Cone O-ring L.T.

| O形圈代号 PART NO. | 螺 纹 THREAD | d | b | 管子外径 TUBE O.D. |
|-------------------|------------|------|-----|-------------------|
| O04.5x1.5 | M12X1.5 | 4.5 | 1.5 | 6 |
| O06.5x1.5 | M14X1.5 | 6.5 | 1.5 | 8 |
| O08.0x1.5 | M16X1.5 | 8.0 | 1.5 | 10 |
| O10.0x1.5 | M18X1.5 | 10.0 | 1.5 | 12 |
| O12.0x2.0 | M22X1.5 | 12.0 | 2.0 | 15 |
| O15.0x2.0 | M26X1.5 | 15.0 | 2.0 | 18 |
| O15.0x2.0 | M27X1.5 | 15.0 | 2.0 | 18 |
| O20.0x2.0 | M30X2 | 20.0 | 2.0 | 22 |
| O26.0x2.0 | M36X2 | 26.0 | 2.0 | 28 |
| O32.0x2.5 | M45X2 | 32.0 | 2.5 | 35 |
| O38.0x2.5 | M52X2 | 38.0 | 2.5 | 42 |

DIN 24° 锥重系列O形圈密封用O形圈
For DIN 24° Cone O-ring H.T.

| O形圈代号 PART NO. | 螺 纹 THREAD | d | b | 管子外径 TUBE O.D. |
|-------------------|------------|------|-----|-------------------|
| O04.5x1.5 | M14X1.5 | 4.5 | 1.5 | 6 |
| O06.5x1.5 | M16X1.5 | 6.5 | 1.5 | 8 |
| O08.0x1.5 | M18X1.5 | 8.0 | 1.5 | 10 |
| O10.0x1.5 | M20X1.5 | 10.0 | 1.5 | 12 |
| O11.0x2.0 | M22X1.5 | 11.0 | 2.0 | 14 |
| O13.0x2.0 | M24X1.5 | 13.0 | 2.0 | 16 |
| O16.3x2.4 | M30X2 | 16.3 | 2.4 | 20 |
| O20.3x2.4 | M36X2 | 20.3 | 2.4 | 25 |
| O25.3x2.4 | M42X2 | 25.3 | 2.4 | 30 |
| O33.3x2.4 | M52X2 | 33.3 | 2.4 | 38 |

美制ORFS外螺纹平面O形圈密封用O形圈
For ORFS Male O-ring

| O形圈代号 PART NO. | 螺 纹 THREAD | d | b |
|-------------------|---------------|-------|------|
| O011 | 9/16"x18UNF | 7.65 | 1.78 |
| O012 | 11/16"x16UN | 9.25 | 1.78 |
| O014 | 13/16"x16UN | 12.42 | 1.78 |
| O016 | 1"x14UNSF | 15.6 | 1.78 |
| O018 | 1.3/16"x12UN | 18.77 | 1.78 |
| O021 | 1.7/16"x12UN | 23.52 | 1.78 |
| O025 | 1.11/16"x12UN | 29.87 | 1.78 |
| O029 | 2"x12UN | 37.82 | 1.78 |

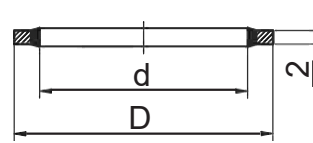

组合垫 Bonded Seal

SAE法兰用O形圈
For SAE Flange O-ring

| O形圈代号 PART NO. | 法兰型号 FLANGE SIZE | d | b |
|-------------------|---------------------|-------|------|
| O210 | 1/2" | 18.64 | 3.53 |
| O214 | 3/4" | 24.99 | 3.53 |
| O219 | 1" | 32.92 | 3.53 |
| O222 | 1.1/4" | 37.69 | 3.53 |
| O225 | 1.1/2" | 47.22 | 3.53 |
| O228 | 2" | 56.74 | 3.53 |
| O232 | 2.1/4" | 69.44 | 3.53 |

JIS法兰用O形圈 For JIS Flange O-Ring

| O形圈代号 PART NO. | 法兰型号 FLANGE SIZE | d | b |
|-------------------|---------------------|-------|------|
| O212 | 5/8" | 21.82 | 3.53 |

英管外螺纹O形圈密封接头用O形圈
For BSP Male O-ring

| O形圈代号 PART NO. | 螺 纹 THREAD | d | b |
|-------------------|------------|-------|------|
| O011 | G1/8"X28 | 7.65 | 1.78 |
| O111 | G1/4"X19 | 10.77 | 2.62 |
| O113 | G3/8"X19 | 13.94 | 2.62 |
| O115 | G1/2"X14 | 17.12 | 2.62 |
| O910 | G5/8"X14 | 19.18 | 2.46 |
| O119 | G3/4"X14 | 23.47 | 2.62 |
| O217 | G1"X11 | 29.74 | 3.53 |
| O222 | G1.1/4"X11 | 37.69 | 3.53 |
| O224 | G1.1/2"X11 | 44.04 | 3.53 |
| O139 | G2"X11 | 54 | 3 |

美制SAE外螺纹 O形圈密封接头用O形圈
For SAE Male O-ring

| O形圈代号 PART NO. | 螺 纹 THREAD | d | b |
|-------------------|--------------|-------|------|
| O904 | 7/16"x20UNF | 8.92 | 1.83 |
| O905 | 1/2"x20UNF | 10.52 | 1.83 |
| O906 | 9/16"x18UNF | 11.89 | 1.98 |
| O908 | 3/4"x16UNF | 16.36 | 2.21 |
| O910 | 7/8"x14UNF | 19.18 | 2.46 |
| O912 | 1.1/16"x12UN | 23.47 | 2.95 |
| O914 | 1.3/16"x12UN | 26.62 | 2.95 |
| O916 | 1.5/16"x12UN | 29.74 | 2.95 |
| O920 | 1.5/8"x12UN | 37.46 | 3.00 |
| O924 | 1.7/8"x12UN | 43.69 | 3.00 |
| O932 | 2.1/2"x12UN | 59.36 | 3.00 |

N

附加资料 Information

英管内螺纹60°外锥面用O形圈
For BSP Female 60° Cone O-ring

| O形圈代号 PARTNO. | 螺 纹 THREAD | d | b |
|------------------|------------|------|-----|
| O171 | G3/4"X14 | 17.1 | 1.6 |
| O221 | G1"X11 | 22.1 | 1.6 |
| O291 | G1.1/4"X11 | 29.1 | 1.6 |
| O351 | G1.1/2"X11 | 35.1 | 1.6 |

水管接头用O形圈 For Waterwash O-ring

| O形圈代号 PARTNO. | 螺 纹 THREAD | d | b |
|------------------|------------|------|-----|
| O10.0X2.0 | M22x1.5 | 10.0 | 2.0 |

SAE矿用接头用O形圈
For SAE Staplelok O-ring

| O形圈代号 PARTNO. | 接头规格 FITTING SIZE | d | b |
|------------------|----------------------|------|-----|
| O06.0X2.0 | -04 | 6.0 | 2.0 |
| O10.0X2.0 | -06 | 10.0 | 2.0 |
| O13.0X2.5 | -08 | 13.0 | 2.5 |
| O19.0X2.5 | -12 | 19.0 | 2.5 |
| O25.0X2.5 | -16 | 25.0 | 2.5 |
| O33.0X2.5 | -20 | 33.0 | 2.5 |
| O40.0X3.0 | -24 | 40.0 | 3.0 |
| O50.0X3.0 | -32 | 50.0 | 3.0 |

公制外螺纹可调向柱端用O形圈
For Metric Male Adjustable Stud End O-ring

| O形圈代号 PARTNO. | 螺 纹 THREAD | d | b |
|------------------|------------|------|-----|
| O06.1X1.6 | M8X1 | 6.1 | 1.6 |
| O08.1X1.6 | M10X1 | 8.1 | 1.6 |
| O09.3X2.4 | M12X1.5 | 9.3 | 2.4 |
| O11.3X2.4 | M14X1.5 | 11.3 | 2.4 |
| O13.3X2.4 | M16X1.5 | 13.3 | 2.4 |
| O15.3X2.4 | M18X1.5 | 15.3 | 2.4 |
| O17.3X2.4 | M20X1.5 | 17.3 | 2.4 |
| O19.3X2.4 | M22X1.5 | 19.3 | 2.4 |
| O21.3X3.0 | M24X1.5 | 21.3 | 3.0 |
| O23.5X3.0 | M26X1.5 | 23.5 | 3.0 |
| O23.5X3.0 | M27X2 | 23.5 | 3.0 |
| O26.5X3.0 | M30X2 | 26.5 | 3.0 |
| O29.5X3.0 | M33X2 | 29.5 | 3.0 |
| O38.5X3.0 | M42X2 | 38.5 | 3.0 |
| O44.5X3.0 | M48X2 | 44.5 | 3.0 |
| O56.2X3.0 | M60X2 | 56.2 | 3.0 |

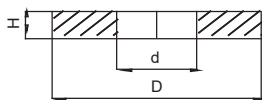

压力表紫铜垫片

| 垫片代号PART NO. | d | D | H |
|--------------|---|----|---|
| DP-B04G | 6 | 11 | 2 |
| DP-B08G | 6 | 18 | 2 |

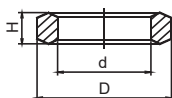

压力表钢垫片

| 垫片代号PART NO. | d | D | H |
|--------------|----|------|-----|
| DP-B04DK | 6 | 11.3 | 4.5 |
| DP-B08DK | 12 | 18.5 | 5 |

六角端面密封用组合垫 Bonded Seal

| 组合垫代号PART NO. | 螺 纹 THREAD | d | D |
|---------------|---------------|------|----|
| ZHD-10 | M10 、 G1/8" | 10.4 | 16 |
| ZHD-14 | M14 、 G1/4" | 14.4 | 20 |
| ZHD-16 | M16 | 16.4 | 22 |
| ZHD-18 | M18 、 G3/8" | 18.4 | 25 |
| ZHD-22 | M22 、 G1/2" | 22.5 | 30 |
| ZHD-24 | M24 | 24.5 | 32 |
| ZHD-27 | M27 、 G3/4" | 27.5 | 35 |
| ZHD-30 | M30 | 30.5 | 38 |
| ZHD-33 | M33 、 G1" | 33.5 | 42 |
| ZHD-36 | M36 | 36.6 | 46 |
| ZHD-42 | M42 、 G1.1/4" | 42.6 | 53 |
| ZHD-45 | M45 | 45.6 | 56 |
| ZHD-48 | M48 、 G1.1/2" | 48.7 | 60 |
| ZHD-52 | M52 | 52.7 | 66 |
| ZHD-60 | M60 、 G2" | 60.7 | 75 |

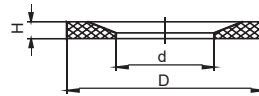

胶垫 CAPTIVE

| 胶垫代号PART NO. | 螺 纹 THREAD | d | D | H |
|--------------|------------|------|------|-----|
| WD-B02 | G1/8"X28 | 8.4 | 11.9 | 1.0 |
| WD-B04 | G1/4"X19 | 11.6 | 16.5 | 1.5 |
| WD-B06 | G3/8"X19 | 14.7 | 18.9 | 1.5 |
| WD-B08 | G1/2"X14 | 18.5 | 23.9 | 1.5 |
| WD-B12 | G3/4"X14 | 23.9 | 29.2 | 1.5 |
| WD-B16 | G1"X11 | 29.7 | 35.7 | 2.0 |
| WD-B20 | G1.1/4"X11 | 38.8 | 45.8 | 2.0 |
| WD-B24 | G1.1/2"X11 | 44.7 | 50.7 | 2.0 |
| WD-B02 | M10X1 | 8.4 | 11.9 | 1.0 |
| WD-M12 | M12X1.5 | 9.8 | 14.4 | 1.5 |
| WD-M14 | M14X1.5 | 11.8 | 16.5 | 1.5 |
| WD-M16 | M16X1.5 | 13.8 | 18.9 | 1.5 |
| WD-M18 | M18X1.5 | 15.7 | 20.9 | 1.5 |
| WD-M20 | M20X1.5 | 17.8 | 22.9 | 1.5 |
| WD-M22 | M22X1.5 | 19.6 | 24.3 | 1.5 |
| WD-B12 | M26X1.5 | 23.9 | 29.2 | 1.5 |
| WD-B12 | M27X2 | 23.9 | 29.2 | 1.5 |
| WD-B16 | M33X2 | 29.7 | 35.7 | 1.5 |
| WD-B20 | M42X2 | 38.8 | 45.8 | 2.0 |
| WD-B24 | M48X2 | 44.7 | 50.7 | 2.0 |

单位转换表 Conversion Factor

| 名称 DENOMINATION | 单位 UNIT | 转换单位 CONVERSION UNIT | 转换系数 FACTOR |
|--------------------|------------------------|-------------------------|------------------|
| 长度 LENGTH | 英寸in | 毫米mm | 25.4 |
| | 毫米mm | 英寸in | 0.03937 |
| | 英尺ft | 米m | 0.3048 |
| | 米m | 英尺ft | 3.28084 |
| 面积 AREA | 平方英寸in ² | 平方厘米cm ² | 6.4516 |
| | 平方厘米cm ² | 平方英寸in ² | 0.1550 |
| 体积 VOLUME | 英加仑gal | 升l | 4.54609 |
| | 升l | 英加仑gal | 0.219969 |
| | 美加仑gal | 升l | 3.78541 |
| | 升l | 美加仑gal | 0.264172 |
| | 升l | 分米 ³ | 1 |
| 质量 MASS | 磅lb | 千克kg | 0.453592 |
| | 千克kg | 磅lb | 2.204622 |
| 力矩 TORQUE | 磅力.英寸lbf.in | 牛.米N.m | 0.112985 |
| | 牛.米N.m | 磅力.英寸lbf.in | 8.85075 |
| 压力 PRESSURE | 磅力/英寸 ² psi | 巴bar | 0.06895 |
| | 巴bar | 磅力/英寸 ² psi | 14.5038 |
| | 磅力/英寸 ² psi | 兆帕MPa | 0.006895 |
| | 兆帕MPa | 磅力/英寸 ² psi | 145.038 |
| | 兆帕MPa | 巴bar | 10 |
| | 巴bar | 兆帕MPa | 0.1 |
| | 帕Pa | 巴bar | 10 ⁻⁵ |
| | 巴bar | 帕Pa | 10 ⁵ |
| 速度 VELOCITY | 英尺/秒ft/s | 米/秒m/s | 0.3048 |
| | 米/秒m/s | 英尺/秒ft/s | 3.28084 |
| 流量 FLOW RATE | 英加仑/分gal/min. | 升/分l/min. | 4.54609 |
| | 升/分l/min. | 英加仑/分gal/min. | 0.219969 |
| | 美加仑/分gal/min. | 升/分l/min. | 3.78541 |
| | 升/分l/min. | 美加仑/分gal/min. | 0.264172 |
| 温度 TEMPERATURE | 华氏度°F | 摄氏度°C | 5/9* (华氏温度°F-32) |
| | 摄氏度°C | 华氏度°F | 摄氏温度°C*9/5+32 |

N

型号索引 Part NO. Index

| 型号 PART NO. | 页码 PAGE |
|-----------------|------------|
| 1B | PF1 |
| 1B-HS | PF9 |
| 1B-WD | PF11 |
| 1B-2WD | PF2 |
| 1B4 | PF3 |
| 1B9 | PF4 |
| 1BG | PF5 |
| 1BG-OG | PF6 |
| 1BG4-OG | PF5 |
| 1BG9-OG | PF6 |
| 1BH | PF7 |
| 1BH9-OG | PF8 |
| 1BJ | PF10 |
| 1BK | PF12 |
| 1BM | PF13 |
| 1BM-WD | PF14 |
| 1BN | PF15 |
| 1BO | PF16 |
| 1BT-SP | PF11 |
| 1BT9-SP | PF17 |
| 1C、1D | PB1 |
| 1C、1D变径 | PB2 |
| 1C9、1D9 | PB3 |
| 1CB-WD、DB-WD | PB4 |
| 1CFL-W、1DFL-W | PM1 |
| 1CG、1DG | PB5 |
| 1CG9-OG、1DG9-OG | PB6 |
| 1CH、1DH | PB7 |
| 1CH9-OG、1DH9-OG | PB8 |
| 1CI、1DI | PB9 |
| 1CJ、1DJ | PB10 |
| 1CM-WD、1DM-WD | PB11 |
| 1CN、1DN | PB12 |
| 1CO、1DO | PB13 |
| 1CT-SP、1DT-SP | PB14 |
| 1CW、1DW | PB15 |
| 1DFS-WD | PM1 |
| 1F | PI1 |
| 1F9 | PI2 |
| 1FFL | PM2 |
| 1FFS | PM2 |
| 1FH | PI2 |
| 1FH9-OG | PI3 |
| 1FN | PI4 |
| 1FN9 | PI5 |
| 1FO | PI6 |
| 1FO9-OG | PH7 |
| 1FO9-OG/L | PI8 |
| 1H | PD1 |
| 1J | PH1 |
| 1J9 | PH2 |
| 1JB-WD | PH3 |
| 1JF | PH4 |
| 1JFL | PM3 |

| 型号 PART NO. | 页码 PAGE |
|----------------|------------|
| 1JFL9 | PM3 |
| 1JFS | PM4 |
| 1JFS9 | PM5 |
| 1JG | PH5 |
| 1JG9-OG | PH6 |
| 1JG-L | PH7 |
| 1JH | PH8 |
| 1JH9-OG | PH9 |
| 1JK | PH7 |
| 1JM | PH10 |
| 1JM-WD | PH11 |
| 1JN | PH12 |
| 1JN9 | PH13 |
| 1JN9-L | PH14 |
| 1JN9-LL | PH14 |
| 1JN-L | PH15 |
| 1JN-LL | PH15 |
| 1JO | PH16 |
| 1JO4-OG | PH17 |
| 1JO9-OG | PH18 |
| 1JO9-OG/L | PH19 |
| 1JO-L | PH19 |
| 1JS | PH20 |
| 1JT4-SP | PH21 |
| 1JT9-SP | PH22 |
| 1JW | PH23 |
| 1JW9-IN | PH23 |
| 1K | PC1 |
| 1KG | PC1 |
| 1KH | PC2 |
| 1KN | PC2 |
| 1KT-SP | PC3 |
| 1N | PJ1 |
| 1N9 | PJ2 |
| 1NO | PJ3 |
| 1NO9-OG | PJ3 |
| 1NP | PL1 |
| 1NT | PJ4 |
| 1O-OG | PH24 |
| 1OT-SP | PG1 |
| 1S | PE1 |
| 1SB | PE1 |
| 1SG | PE2 |
| 1SG9-OG | PE2 |
| 1SN | PE3 |
| 1SO | PE3 |
| 1ST-SP | PE4 |
| 1T9-SP | PG2 |
| 1T-SP | PG1 |
| 2B | PF18 |
| 2B9 | PF19 |
| 2B-G | PF19 |
| 2BJ | PF20 |
| 2C | PB16 |

| 型号 PART NO. | 页码 PAGE |
|----------------|------------|
| 2C9、2D9 | PB17 |
| 2D | PB18 |
| 2F | PI9 |
| 2F9 | PI10 |
| 2FU9 | PK1 |
| 2GB | PF21 |
| 2GJ | PH24 |
| 2HB | PH22 |
| 2J | PH25 |
| 2J4 | PH26 |
| 2J9 | PH27 |
| 2JB | PH28 |
| 2JF | PH29 |
| 2MJ | PD2 |
| 2NB | PF23 |
| 2NF | PI10 |
| 2NJ | PH30 |
| 2NJ9 | PH29 |
| 2NU | PK2 |
| 2NU9 | PK3 |
| 2NU9-L | PK4 |
| 2OB | PF24 |
| 2OF | PI11 |
| 2OJ | PH31 |
| 2OU | PK4 |
| 2S | PE5 |
| 2TB9-SP | PF24 |
| 2TB-G/SP | PF25 |
| 2TB-SP | PF25 |
| 2TJ-SP | PH32 |
| 3B | PF26 |
| 3J | PH33 |
| 4B | PF27 |
| 4BN-WD | PF28 |
| 4B-WD | PF28 |
| 4C、4D | PB19 |
| 4F | PI11 |
| 4FL-4FS | PM5 |
| 4H | PD2 |
| 4J | PH34 |
| 4K | PC3 |
| 4M | PD3 |
| 4MN-WD | PD3 |
| 4N | PJ5 |
| 4NN | PJ5 |
| 4O | PH34 |
| 4ON | PH32 |
| 4S | PE5 |
| 4TN-GM | PG3 |
| 4T-SP | PG3 |
| 5B | PF29 |
| 5B-G | PF27 |
| 5B-HS | PF30 |
| 5BN | PF31 |

| 型号 PART NO. | 页码 PAGE |
|----------------|------------|
| 5BT | PF31 |
| 5F-S | PI12 |
| 5GB | PF32 |
| 5GN | PJ6 |
| 5HN | PJ6 |
| 5J | PH35 |
| 5JB | PH36 |
| 5JB-G | PH37 |
| 5JB-GDK | PH37 |
| 5JN | PH38 |
| 5JN9 | PH38 |
| 5JN-BH | PH39 |
| 5JT | PH40 |
| 5JT9 | PH40 |
| 5N | PJ7 |
| 5NB | PF33 |
| 5NO | PJ8 |
| 5NT | PJ9 |
| 5O | PH41 |
| 5OB | PF34 |
| 5ON | PJ10 |
| 5OT | PG4 |
| 5T9-SP | PG4 |
| 5TB9-SP | PF34 |
| 5TB-SP | PF35 |
| 5TN-SP | PJ9 |
| 5T-SP | PG5 |
| 6B | PF32 |
| 6C、6D | PB20 |
| 6F | PI13 |
| 6J | PH42 |
| 6J9 | PH43 |
| 6NJ | PH44 |
| 6S | PE6 |
| 7B | PF36 |
| 7B9-PK | PF37 |
| 7B-S | PF37 |
| 7JN | PH44 |
| 7N | PJ11 |
| 7N9-PK | PJ12 |
| 7NU-S | PK5 |
| 7T | PG6 |
| 7T9-PK | PG7 |
| 8C | PB21 |
| 8F | PI13 |
| 8J | PH45 |
| 8J-OG | PH45 |
| 9B | PF38 |
| 9C、9D | PB22 |
| 9F | PI14 |
| 9J | PH46 |
| 9J-CAP | PH46 |
| 9K | PC4 |
| 9N-CAP | PJ12 |

